

ASSEMBLEA ORDINARIA 12 MAGGIO 2016

Segreteria Societaria - Ufficio Titoli



81607/1003

15
M

1

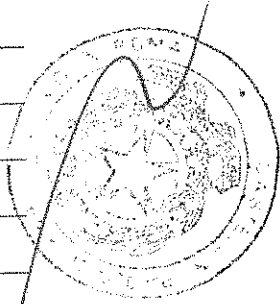

Unica convocazione

Esito della votazione sul punto 1

Bilancio di esercizio al 31 dicembre 2015 di Eni S.p.A. Deliberazioni relative.
Presentazione Bilancio consolidato al 31 dicembre 2015. Relazioni degli
Amministratori, del Collegio Sindacale e della Società di revisione

Elenco Favorevoli

SCHEDA	VPC	NOMINATIVO AZIONISTA	DELEGATO	NUMERO DI AZIONI TOTALE
2892		TEMPLETON INTERNATIONAL STOCK TRUST.	CARDARELLI ANGELO	159.021
2891		TEMPLETON MASTER TRUST - SERIES 1	CARDARELLI ANGELO	213.477
2890		TEMPLETON MASTER TRUST - SERIES 2	CARDARELLI ANGELO	27.821
2947		TEMPLETON NVIT INTERNATIONAL VALUE FUND	CARDARELLI ANGELO	133.715
2920		TEMPLETON WORLD FUND	CARDARELLI ANGELO	3.695.594
1247		TENNESSEE CONSOLIDATED RETIREMENT SYSTEM	CARDARELLI ANGELO	96.292
690		TENNESSEE VALLEY AUTHORITY RETIREMENT SYSTEM	CARDARELLI ANGELO	29.878
684		TEXAS EDUCATION AGENCY .	CARDARELLI ANGELO	673.656
1139		TEXAS MUNICIPAL RETIREMENT SYSTEM	CARDARELLI ANGELO	286.053
2971		TFL PENSION FUND	CARDARELLI ANGELO	626.657
931		THE ALLIANCEBERNSTEIN POOLING PTF - ALLIANCEB VOL MNGM PTF	CARDARELLI ANGELO	67.672
930		THE ALLIANCEBERNSTEIN POOLING PTF-ALLIANCEBR MULTASS REAL RTP	CARDARELLI ANGELO	8.206
268		THE BANK OF KOREA	CARDARELLI ANGELO	45.549
269		THE BANK OF KOREA	CARDARELLI ANGELO	111.184
270		THE BANK OF KOREA	CARDARELLI ANGELO	92.199
277		THE BANK OF KOREA	CARDARELLI ANGELO	86.395
280		THE BANK OF KOREA	CARDARELLI ANGELO	129.968
2977		THE BARCLAYS BANK UK RETIREMENT FUND	CARDARELLI ANGELO	6.869
2001		THE BARING MULTI ASSET F, A SUBF BARING MULTI ASSET INV F	CARDARELLI ANGELO	20.790
495		THE BOARD OF PENSIONS OF THE PRESBYTERIAN CHURCH	CARDARELLI ANGELO	210.159
2869		THE BOEING COMPANY EMPLOYEE RETIREMENT P	CARDARELLI ANGELO	919.951
2872		THE BOEING COMPANY EMPLOYEE RETIREMENT P	CARDARELLI ANGELO	23.720
1034		THE BOEING COMPANY EMPLOYEE SAVINGS PLANS MASTER TRUST	CARDARELLI ANGELO	115.191

ASSEMBLEA ORDINARIA81607/1004 **12 MAGGIO 2016**

Segreteria Societaria - Ufficio Titoli



Unica convocazione

Esito della votazione sul punto 1

Bilancio di esercizio al 31 dicembre 2015 di Eni S.p.A. Deliberazioni relative.
Presentazione Bilancio consolidato al 31 dicembre 2015. Relazioni degli
Amministratori, del Collegio Sindacale e della Società di revisione

Elenco Favorevoli

SCHEDA	VPC	NOMINATIVO AZIONISTA	DELEGATO	NUMERO DI AZIONI TOTALE
3254		THE BOMBARDIER TRUST (UK)	CARDARELLI ANGELO	31.716
2975		THE BRITISH STEEL PENSION SCHEME	CARDARELLI ANGELO	473.621
502		THE CANADA LIFE ASSURANCE COMPANY	CARDARELLI ANGELO	118.984
503		THE CANADA LIFE ASSURANCE COMPANY	CARDARELLI ANGELO	31.453
504		THE CANADA LIFE ASSURANCE COMPANY	CARDARELLI ANGELO	16.508
505		THE CANADA LIFE ASSURANCE COMPANY	CARDARELLI ANGELO	25.161
518		THE CHRYSLER CANADA INC.CANADIAN MASTER TRUST FUND	CARDARELLI ANGELO	60.864
498		THE CLEVELAND CLINIC FOUNDATION	CARDARELLI ANGELO	6.342
740		THE DUN AND BRADSTREET CORP DEFINED BENEFIT GROUP TRUST	CARDARELLI ANGELO	18.796
2049		THE EUROPEAN INVESTMENT TRUST PLC	CARDARELLI ANGELO	1.035.495
1042		THE GABELLI GLOBAL UTILITY & INCOME TRUST	CARDARELLI ANGELO	1.000
908		THE GEORGE PUTNAM FUND OF BOSTON	CARDARELLI ANGELO	141.654
729		THE GEORGE WASHINGTON UNIVERSITY	CARDARELLI ANGELO	7.897
1843		THE GRAUSTEIN TRUSTS PARTNERSHIP	CARDARELLI ANGELO	1.093
3249		THE GREAT-WEST LIFE ASSURANCE COMPAN	CARDARELLI ANGELO	137.285
553		THE GREAT-WEST LIFE ASSURANCE COMPANY	CARDARELLI ANGELO	40.737
554		THE GREAT-WEST LIFE ASSURANCE COMPANY	CARDARELLI ANGELO	19.036
556		THE GREAT-WEST LIFE ASSURANCE COMPANY	CARDARELLI ANGELO	14.475
1057		THE HARTFORD GLOBAL ALL- ASSET FUND	CARDARELLI ANGELO	10.560
1056		THE HARTFORD GLOBAL REAL ASSET FUND	CARDARELLI ANGELO	232.012
1052		THE HARTFORD INTERNATIONAL GROWTH FUND	CARDARELLI ANGELO	96.031
1053		THE HARTFORD INTERNATIONAL OPPORTUNITIES FUND	CARDARELLI ANGELO	892.625
1055		THE HARTFORD INTERNATIONAL VALUE FUND	CARDARELLI ANGELO	1.012.453

ASSEMBLEA ORDINARIA

12 MAGGIO 2016

Segreteria Societaria - Ufficio Titoli



81607/1005

Unica convocazione

Esito della votazione sul punto 1

Bilancio di esercizio al 31 dicembre 2015 di Eni S.p.A. Deliberazioni relative.
Presentazione Bilancio consolidato al 31 dicembre 2015. Relazioni degli
Amministratori, del Collegio Sindacale e della Società di revisione

Handwritten signature

Handwritten signature

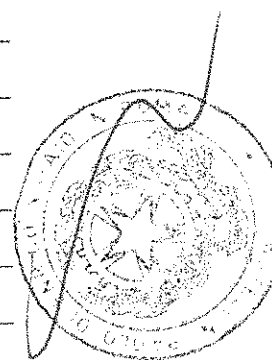

Elenco Favorevoli

SCHEDA	VPC	NOMINATIVO AZIONISTA	DELEGATO	NUMERO DI AZIONI TOTALE
558		THE HARTFORD ROMAN CATHOLIC	DIOCESAN CORP RET PL CARDARELLI ANGELO	1.215
1760		THE HEALTH FOUNDATION	CARDARELLI ANGELO	177.887
454		THE HEARST CORPORATION MASTER TRUST FOR PENSION E PROFIT SHARING	CARDARELLI ANGELO	35.438
2881		THE INVESTMENT COMPANY OF AMERICA	CARDARELLI ANGELO	14.538.061
1844		THE JBUT MASTER INVESTMENT PARTNERSHIP LLP	CARDARELLI ANGELO	5.836
1910		THE LEVERHULME TRUST	CARDARELLI ANGELO	16.409
1959		THE LILLY RETIREMENT PLAN MASTER TRUST	CARDARELLI ANGELO	40.768
576		THE MANUFACTURERS LIFE INSURANCE COMPANY	CARDARELLI ANGELO	146.897
453		THE MARS ASSOCIATES' RETIREMENT PLAN	CARDARELLI ANGELO	64.453
972		THE MASTER TR BK OF JP LTD ATF INVESCO DEV COUNT EQ INDEX M F	CARDARELLI ANGELO	257
3061		THE MASTER TRUST BANK OF JAPAN	CARDARELLI ANGELO	13.980
2962		THE MASTER TRUST BANK OF JAPAN LTD	CARDARELLI ANGELO	2.965.924
2963		THE MASTER TRUST BANK OF JAPAN LTD	CARDARELLI ANGELO	2.971.186
2982		THE MASTER TRUST BANK OF JAPAN LTD	CARDARELLI ANGELO	2.900.845
2359		THE MASTER TRUST BANK OF JAPAN LTD	CARDARELLI ANGELO	12.000
2360		THE MASTER TRUST BANK OF JAPAN LTD	CARDARELLI ANGELO	77.228
2374		THE MASTER TRUST BANK OF JAPAN LTD	CARDARELLI ANGELO	40.348
2375		THE MASTER TRUST BANK OF JAPAN LTD	CARDARELLI ANGELO	2.840
2376		THE MASTER TRUST BANK OF JAPAN LTD	CARDARELLI ANGELO	7.964
2386		THE MASTER TRUST BANK OF JAPAN LTD	CARDARELLI ANGELO	30.153
2394		THE MASTER TRUST BANK OF JAPAN LTD	CARDARELLI ANGELO	4.206
2413		THE MASTER TRUST BANK OF JAPAN LTD	CARDARELLI ANGELO	18.062
2419		THE MASTER TRUST BANK OF JAPAN LTD	CARDARELLI ANGELO	14.000

ASSEMBLEA ORDINARIA

81607/1006

12 MAGGIO 2016

Segreteria Societaria - Ufficio Titoli

**eni**

Unica convocazione

Esito della votazione sul punto 1

Bilancio di esercizio al 31 dicembre 2015 di Eni S.p.A. Deliberazioni relative.
Presentazione Bilancio consolidato al 31 dicembre 2015. Relazioni degli
Amministratori, del Collegio Sindacale e della Società di revisione

Elenco Favorevoli

SCHEDA	VPC	NOMINATIVO AZIONISTA	DELEGATO	NUMERO DI AZIONI TOTALE
2964		THE MASTER TRUST BANK OF JAPAN, LTD AS TRUSTEE FOR MUTB400045796	CARDARELLI ANGELO	2.954.336
2979		THE MASTER TRUST BANK OF JAPAN, LTD. AS TRUSTEE FOR MUTB400045792	CARDARELLI ANGELO	3.007.995
942		THE MASTER TRUST BK OF JP LTD: HITACHI FOREIGN EQ INDEX MF	CARDARELLI ANGELO	52.596
974		THE MASTER TRUST BK OF JP RE F RUSSELL INV (JP) INTL EQUITY F	CARDARELLI ANGELO	62.540
462		THE MEDICAL CENTRE INSURANCE COMPANY LTD.	CARDARELLI ANGELO	24.940
3171		THE METHODIST CHURCH IN IRELAND EQ FUND	CARDARELLI ANGELO	20.300
860		THE METHODIST HOSPITAL	CARDARELLI ANGELO	82.735
1852		THE NEW YORK TIMES COMPANY PENSION TRUST	CARDARELLI ANGELO	21.353
38		THE NOMURA TRUST AND BANKING CO LTD	CARDARELLI ANGELO	52.336
39		THE NOMURA TRUST AND BANKING CO LTD	CARDARELLI ANGELO	2.250
456		THE NORTH CAROLINA SUPPLEMENTAL RETIREMENT PLANS GROUP TRUST	CARDARELLI ANGELO	437.537
1825		THE NORTHERN TRUST COMPANY SUB-ADVISED COLLECTIVE FUNDS TRUST	CARDARELLI ANGELO	294.850
1826		THE NORTHERN TRUST COMPANY SUB-ADVISED COLLECTIVE FUNDS TRUST	CARDARELLI ANGELO	359.081
1119		THE PRUDENTIAL INSURANCE COMPANY OF AMERICA	CARDARELLI ANGELO	101.558
1120		THE PRUDENTIAL INSURANCE COMPANY OF AMERICA	CARDARELLI ANGELO	110.671
1325		THE PRUDENTIAL INSURANCE COMPANY OF AMERICA	CARDARELLI ANGELO	39.000
242		THE PRUDENTIAL INVESTMENT PORTFOLIOS INCDRYDEN ACTIVE ALLOCATION	CARDARELLI ANGELO	4.558
1018		THE REGENTS OF THE UNIVERSITY OF CALIFORNIA	CARDARELLI ANGELO	254.787
1019		THE REGENTS OF THE UNIVERSITY OF CALIFORNIA	CARDARELLI ANGELO	1.671.272
1020		THE REGENTS OF THE UNIVERSITY OF CALIFORNIA	CARDARELLI ANGELO	88.097
1021		THE REGENTS OF THE UNIVERSITY OF CALIFORNIA	CARDARELLI ANGELO	99.226
1524		THE REGENTS OF THE UNIVERSITY OF CALIFORNIA	CARDARELLI ANGELO	408.964
1983		THE REPRESENTATIVE CHURCH BODY	CARDARELLI ANGELO	73.522

ASSEMBLEA ORDINARIA 12 MAGGIO 2016

Segreteria Societaria - Ufficio Titoli



eni

81607/1007

M. S. M.

M. S. M.

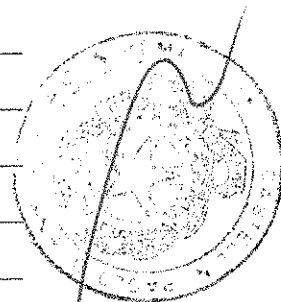

Unica convocazione

Esito della votazione sul punto 1

**Bilancio di esercizio al 31 dicembre 2015 di Eni S.p.A. Deliberazioni relative.
Presentazione Bilancio consolidato al 31 dicembre 2015. Relazioni degli
Amministratori, del Collegio Sindacale e della Società di revisione**

Elenco Favorevoli

SCHEDA	VPC	NOMINATIVO AZIONISTA	DELEGATO	NUMERO DI AZIONI TOTALE
1474		THE RETIREMENT ANN PL FOR EMPL OF THE ARMY&AIR FORCE EX SERV	CARDARELLI ANGELO	126.480
423		THE ROYAL BANK OF SCOTLAND GROUP PENSION FUND	CARDARELLI ANGELO	1.198.291
424		THE ROYAL BANK OF SCOTLAND GROUP PENSION FUND	CARDARELLI ANGELO	684.450
295		THE ROYAL BANK OF SCOTLAND PLC AS TRUSTEE OF BLACKROCK WORLDRESOURCES INCOME FU	CARDARELLI ANGELO	41.169
1688		THE ROYAL BOROUGH OF GREENWICH PENSION FUND	CARDARELLI ANGELO	24.259
2978		THE ROYAL BOROUGH OF WINDSOR AND MAIDENHEAD AS THEADMINISTERING AUTHORITY OF THE	CARDARELLI ANGELO	336.449
542		THE ROYAL INST FOR THE ADVANCEMENT OF LEARNING MCGILL UNIVERSITY	CARDARELLI ANGELO	9.639
519		THE STATE OF CONNECTICUT ACTINGTHROUGH ITS TREASURER	CARDARELLI ANGELO	234.077
520		THE STATE OF CONNECTICUT ACTINGTHROUGH ITS TREASURER	CARDARELLI ANGELO	422.774
521		THE STATE OF CONNECTICUT ACTINGTHROUGH ITS TREASURER	CARDARELLI ANGELO	332.249
522		THE STATE OF CONNECTICUT ACTINGTHROUGH ITS TREASURER	CARDARELLI ANGELO	38.379
2014		THE TM OVERSTONE UCITS EQUITY INCOME FUND	CARDARELLI ANGELO	108.772
1646		THE TRUSTEES OF AIRWAYS PENSION SCHEME	CARDARELLI ANGELO	103.155
1684		THE TRUSTEES OF AMEC STAFF PENSION SCHEME	CARDARELLI ANGELO	176.356
1662		THE TRUSTEES OF BP PENSION FUND	CARDARELLI ANGELO	645.070
2019		THE TRUSTEES OF CABLE & WIRELESS SUPERANNUATION FUND	CARDARELLI ANGELO	75.850
1677		THE TRUSTEES OF CONOCOPHILLIPS PENSION PLAN	CARDARELLI ANGELO	76.829
1647		THE TRUSTEES OF NEW AIRWAYS PENSION SCHEME	CARDARELLI ANGELO	16.785
1648		THE TRUSTEES OF NEW AIRWAYS PENSION SCHEME	CARDARELLI ANGELO	895.925
1718		THE TRUSTEES OF SAL PENSION SCHEME	CARDARELLI ANGELO	16.410
1675		THE TRUSTEES OF STAGECOACH GROUP PENSION SCHEME	CARDARELLI ANGELO	278.000
2018		THE TRUSTEES OF THE BT PENSION SCHEME	CARDARELLI ANGELO	152.310
1713		THE TRUSTEES OF THE CARNEGIE TRUST FOR UNI OF SCOTLAND	CARDARELLI ANGELO	127.430

ASSEMBLEA ORDINARIA

81607/1008 12 MAGGIO 2016

Segreteria Societaria - Ufficio Titoli



eni

Unica convocazione

Esito della votazione sul punto 1

Bilancio di esercizio al 31 dicembre 2015 di Eni S.p.A. Deliberazioni relative.
Presentazione Bilancio consolidato al 31 dicembre 2015. Relazioni degli
Amministratori, del Collegio Sindacale e della Società di revisione

Elenco Favorevoli

SCHEDA	VPC	NOMINATIVO AZIONISTA	DELEGATO	NUMERO DI AZIONI TOTALE
2028		THE TRUSTEES OF THE CIVIL AVIATION AUTHORITY PENSION SCHEME	CARDARELLI ANGELO	161.224
1928		THE TRUSTEES OF THE HENRY SMITH CHARITY	CARDARELLI ANGELO	90.779
1715		THE TRUSTEES OF THE PHILLIPS 66 UK PENSION PLAN	CARDARELLI ANGELO	17.744
2030		THE TRUSTESS OF IBM PENSION PLAN	CARDARELLI ANGELO	98.527
1562		THE UNIVERSAL INST F INC - GLOBAL STRATEGIST PORTFOLIO	CARDARELLI ANGELO	2.182
985		THE WALT DISNEY COMPANY RETIREMENT PLAN MASTER TRUST	CARDARELLI ANGELO	10.864
986		THE WALT DISNEY COMPANY RETIREMENT PLAN MASTER TRUST	CARDARELLI ANGELO	10.855
1289		THE WELLINGTON TR CO NAT ASS MULT COLLECTIVE INV F TRUST II	CARDARELLI ANGELO	2.800
1291		THE WELLINGTON TR CO NAT ASS MULT COLLECTIVE INV F TRUST II	CARDARELLI ANGELO	138.558
1292		THE WELLINGTON TR CO NAT ASS MULT COLLECTIVE INV F TRUST II	CARDARELLI ANGELO	54.710
1591		THE WELLINGTON TR CO NAT ASS MULT COLLECTIVE INV F TRUST II	CARDARELLI ANGELO	237.992
1574		THE WELLINGTON TR CO NAT ASS MULT COM ALPHA STRATEGIES PTF	CARDARELLI ANGELO	118.087
1593		THE WELLINGTON TR CO NAT ASS MULT COMM TR F TR GLB RES EQ PTF	CARDARELLI ANGELO	10.624
1592		THE WELLINGTON TR CO, NAT ASS MULT COMM TR F TR, INT RES EQ F	CARDARELLI ANGELO	36.696
1286		THE WELLINGTON TR COM NATIONAL ASS MULT COLLECT INV F TRUST	CARDARELLI ANGELO	17.758
1287		THE WELLINGTON TR COM NATIONAL ASS MULT COLLECT INV F TRUST	CARDARELLI ANGELO	8.807
1288		THE WELLINGTON TR COM NATIONAL ASS MULT COLLECT INV F TRUST	CARDARELLI ANGELO	4.385
1589		THE WELLINGTON TR COM NATIONAL ASS MULT COLLECT INV F TRUST	CARDARELLI ANGELO	145.803
1590		THE WELLINGTON TR COM NATIONAL ASS MULT COLLECT INV F TRUST	CARDARELLI ANGELO	21.362
58		THREADNEEDLE (LUX)	CARDARELLI ANGELO	17.457
1441		THRIFT SAVINGS PLAN	CARDARELLI ANGELO	6.924.427
1818		THYSSEN GLOBAL INVESTMENTS CORP	CARDARELLI ANGELO	12.035
989		TIAA-CREF FUNDS - ENHANCED INTERNATIONAL EQUITY INDEX FUND	CARDARELLI ANGELO	219.008

ASSEMBLEA ORDINARIA 12 MAGGIO 2016

Segreteria Societaria - Ufficio Titoli



eni

Unica convocazione

Esito della votazione sul punto 1

81607/1009

**Bilancio di esercizio al 31 dicembre 2015 di Eni S.p.A. Deliberazioni relative.
Presentazione Bilancio consolidato al 31 dicembre 2015. Relazioni degli
Amministratori, del Collegio Sindacale e della Società di revisione**

Elenco Favorevoli

SCHEDA	VPC	NOMINATIVO AZIONISTA	DELEGATO	NUMERO DI AZIONI TOTALE
990		TIAA-CREF FUNDS - TIAA-CREF GLOBAL NATURAL RESOURCES FUND CARDARELLI ANGELO		149.512
1070		TIFF INVESTMENT PROGRAM, INC - TIFF MULTI-ASSET FUND CARDARELLI ANGELO		217.808
1512		TIAA-CREF INTERNATIONAL EQUITY INDEX FUND CARDARELLI ANGELO		1.416.628
732		TIME WARNER CABLE PENSION PLANSMASTER TRUST CARDARELLI ANGELO		97.603
2588		TNCO FONDS CARDARELLI ANGELO		20.000
1881		TORONTO TRANSIT COMMISSON PENSION FUND SOCIETY CARDARELLI ANGELO		82.500
2244		TOUCHSTONE INTERNATIONAL CARDARELLI ANGELO		56.291
975		TOYOTA MOTOR PENSION FUND CARDARELLI ANGELO		29.211
1071		TRANSAMERICA AB DYNAMIC ALLOCATION VP CARDARELLI ANGELO		10.808
1068		TRANSAMERICA INTERNATIONAL EQUITY CARDARELLI ANGELO		1.864.900
1538		TRANSAMERICA INTERNATIONAL EQUITY OPPORTUNITIES CARDARELLI ANGELO		323.228
1069		TRANSAMERICA JPMORGAN TACTICAL ALLOCATION VP CARDARELLI ANGELO		1.256
34		TRANSAMERICA LIFE INSURANCE COMPANY CARDARELLI ANGELO		56.527
1542		TRANSAMERICA MFS INTERNATIONAL EQUITY VP CARDARELLI ANGELO		141.992
1540		TRANSAMERICA TS+W INTERNATIONAL EQUITY VP CARDARELLI ANGELO		82.496
614		TREASURER OF THE STATE OF NORTHCAROLINAEQUITY INVESTMENT FUND POOLED CARDARELLI ANGELO		883.934
615		TREASURER OF THE STATE OF NORTHCAROLINAEQUITY INVESTMENT FUND POOLED CARDARELLI ANGELO		740.404
616		TREASURER OF THE STATE OF NORTHCAROLINAEQUITY INVESTMENT FUND POOLED CARDARELLI ANGELO		34.928
617		TREASURER OF THE STATE OF NORTHCAROLINAEQUITY INVESTMENT FUND POOLED CARDARELLI ANGELO		1.020.600
618		TREASURER OF THE STATE OF NORTHCAROLINAEQUITY INVESTMENT FUND POOLED CARDARELLI ANGELO		2.208.988
619		TREASURER OF THE STATE OF NORTHCAROLINAEQUITY INVESTMENT FUND POOLED CARDARELLI ANGELO		700.827
1929		TRINITY COLLEGE CAMBRIDGE CARDARELLI ANGELO		18.034
2238		TRUST & CUSTODY SERV CARDARELLI ANGELO		165.900

Handwritten signature

Handwritten signature

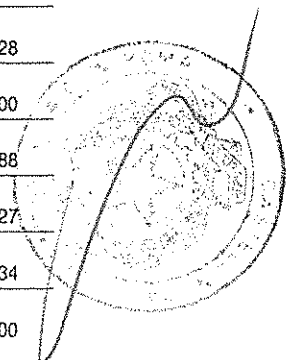

ASSEMBLEA ORDINARIA

81607/Moto 12 MAGGIO 2016

Segreteria Societaria - Ufficio Titoli



eni

Unica convocazione

Esito della votazione sul punto 1

Bilancio di esercizio al 31 dicembre 2015 di Eni S.p.A. Deliberazioni relative.
Presentazione Bilancio consolidato al 31 dicembre 2015. Relazioni degli
Amministratori, del Collegio Sindacale e della Società di revisione

Elenco Favorevoli

SCHEDA	VPC	NOMINATIVO AZIONISTA	DELEGATO	NUMERO DI AZIONI TOTALE
3263		TRUST & CUSTODY SERVICES BANK LTD AS TRUSTEE FOR PENSION INVESTMENT FUND TRUST NUM	CARDARELLI ANGELO	90.845
2236		TRUST AND CUSTODY SERV	CARDARELLI ANGELO	1.526
3046		TRUST AND CUSTODY SERVICED BANK LIMITED	CARDARELLI ANGELO	44.644
3047		TRUST AND CUSTODY SERVICED BANK LIMITED	CARDARELLI ANGELO	119.150
3089		TRUST AND CUSTODY SERVICED BANK LIMITED	CARDARELLI ANGELO	102.278
3090		TRUST AND CUSTODY SERVICED BANK LIMITED	CARDARELLI ANGELO	193.698
3091		TRUST AND CUSTODY SERVICED BANK LIMITED	CARDARELLI ANGELO	21.720
3259		TRUST E CUSTODY SERVICES BANK LTD	CARDARELLI ANGELO	156.251
3260		TRUST E CUSTODY SERVICES BANK LTD	CARDARELLI ANGELO	44.825
3261		TRUST E CUSTODY SERVICES BANK LTD	CARDARELLI ANGELO	14.943
3262		TRUST E CUSTODY SERVICES BANK LTD	CARDARELLI ANGELO	208.473
1473		TRUST FOR RETIR MED, DENT & LIFE INS ARMY&AIR FORCE EXCH	CARDARELLI ANGELO	77.682
1664		TRUSTEES OF KINGFISHER PENSION SCHEME	CARDARELLI ANGELO	23.265
1716		TRUSTEES OF ROYAL INSURANCE GROUP PENSION SCHEME	CARDARELLI ANGELO	29.967
579		TRUSTEES OF THE ESTATE OF BERNICE PAUAHIBISHOP DBA KAMAHAMEHA SCHOOLS	CARDARELLI ANGELO	34.548
572		TS&W COLLECTIVE INVESTMENT TR TS&W INTL LARGE CAP EQUITY TRUST	CARDARELLI ANGELO	209.700
1930		TYCO ELECTRONICS DEFINED BENEFIT PLANS MASTER TRUST	CARDARELLI ANGELO	14.897
607		U.S.AND INTERNATIONAL EQUITY CLASS	CARDARELLI ANGELO	8.257
999		UAW RETIREE MEDICAL BENEFITS TRUST	CARDARELLI ANGELO	16.420
1000		UAW RETIREE MEDICAL BENEFITS TRUST	CARDARELLI ANGELO	8.841
1035		UAW RETIREE MEDICAL BENEFITS TRUST	CARDARELLI ANGELO	45.449
1036		UAW RETIREE MEDICAL BENEFITS TRUST	CARDARELLI ANGELO	25.638
1037		UAW RETIREE MEDICAL BENEFITS TRUST	CARDARELLI ANGELO	13.040

ASSEMBLEA ORDINARIA 12 MAGGIO 2016

Segreteria Societaria - Ufficio Titoli

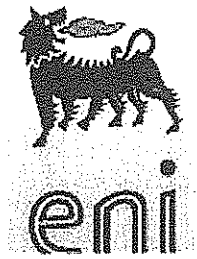

Unica convocazione

Esito della votazione sul punto 1

Bilancio di esercizio al 31 dicembre 2015 di Eni S.p.A. Deliberazioni relative. Presentazione Bilancio consolidato al 31 dicembre 2015. Relazioni degli Amministratori, del Collegio Sindacale e della Società di revisione

81607/1011

Elenco Favorevoli

SCHEDA	VPC	NOMINATIVO AZIONISTA	DELEGATO	NUMERO DI AZIONI TOTALE
1045		UAW RETIREE MEDICAL BENEFITS TRUST	CARDARELLI ANGELO	29.915
1046		UAW RETIREE MEDICAL BENEFITS TRUST	CARDARELLI ANGELO	17.218
1272		UAW RETIREE MEDICAL BENEFITS TRUST	CARDARELLI ANGELO	125.148
1273		UAW RETIREE MEDICAL BENEFITS TRUST	CARDARELLI ANGELO	120.740
1274		UAW RETIREE MEDICAL BENEFITS TRUST	CARDARELLI ANGELO	119.137
1275		UAW RETIREE MEDICAL BENEFITS TRUST	CARDARELLI ANGELO	179.331
1276		UAW RETIREE MEDICAL BENEFITS TRUST	CARDARELLI ANGELO	69.267
1277		UAW RETIREE MEDICAL BENEFITS TRUST	CARDARELLI ANGELO	193.892
1268		UBS (IRL) ETF PLC	CARDARELLI ANGELO	3.032
1269		UBS (IRL) ETF PLC	CARDARELLI ANGELO	17.189
1270		UBS (IRL) ETF PLC	CARDARELLI ANGELO	11.944
89		UBS (LUX) EQUITY SICAV	CARDARELLI ANGELO	7.080
94		UBS (LUX) EQUITY SICAV	CARDARELLI ANGELO	396.719
93		UBS (LUX) SICAV 1	CARDARELLI ANGELO	4.911
95		UBS (LUX) STRATEGY XTRA SICAV	CARDARELLI ANGELO	22.702
2899		UBS (US) GROUP TRUST	CARDARELLI ANGELO	85.011
1386		UBS ETF	CARDARELLI ANGELO	336
1387		UBS ETF	CARDARELLI ANGELO	289
1389		UBS ETF	CARDARELLI ANGELO	1.232.417
1390		UBS ETF	CARDARELLI ANGELO	82.242
1391		UBS ETF	CARDARELLI ANGELO	19.723
1392		UBS ETF	CARDARELLI ANGELO	28.649
1393		UBS ETF	CARDARELLI ANGELO	769.374

L

M

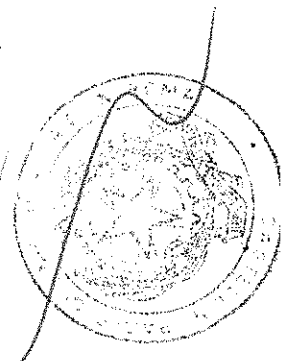

ASSEMBLEA ORDINARIA

81607/1012 12 MAGGIO 2016

Segreteria Societaria - Ufficio Titoli



eni

Unica convocazione

Esito della votazione sul punto 1

Bilancio di esercizio al 31 dicembre 2015 di Eni S.p.A. Deliberazioni relative.
Presentazione Bilancio consolidato al 31 dicembre 2015. Relazioni degli
Amministratori, del Collegio Sindacale e della Società di revisione

Elenco Favorevoli

SCHEDA	VPC	NOMINATIVO AZIONISTA	DELEGATO	NUMERO DI AZIONI TOTALE
1394	UBS ETF		CARDARELLI ANGELO	312.329
1388	UBS ETF-UBS-ETF DJ EURO STOXX 50		CARDARELLI ANGELO	610.947
3141	UBS FTSE RAFI DEVELOPED 1000 INDEX FUND		CARDARELLI ANGELO	70.764
87	UBS FUND MANAGEMENT (SWITZERLAND) AG.		CARDARELLI ANGELO	1.596.650
88	UBS FUND MANAGEMENT(LUXEMBOURG) SA		CARDARELLI ANGELO	72.261
2846	UBS GLOBAL ASSET MANAGEMENT LIFE LTD		CARDARELLI ANGELO	556.303
2915	UBS GLOBAL ASSET MANAGEMENT LIFE LTD		CARDARELLI ANGELO	40.224
2917	UBS GLOBAL ASSET MANAGEMENT LIFE LTD		CARDARELLI ANGELO	149.502
90	UBS GLOBAL SOLUTIONS - GLOBAL EQUITIES EUR		CARDARELLI ANGELO	16.085
91	UBS GLOBAL SOLUTIONS - GLOBAL EQUITIES II EUR		CARDARELLI ANGELO	18.765
1749	UBS IQ MSCI EUROPE ETHICAL ETF		CARDARELLI ANGELO	1.739
1748	UBS IQ MSCI WORLD EX AUSTRALIA ETHICAL ETF		CARDARELLI ANGELO	1.503
2257	UF 6 A ACT		CARDARELLI ANGELO	65.000
580	UFCW CONSOLIDATED PENSION FUND		CARDARELLI ANGELO	795
3242	UKA-FONDS		CARDARELLI ANGELO	49.000
698	UMC BENEFIT BOARD, INC		CARDARELLI ANGELO	53.800
3275	UNION BANCAIRE PRIVEE		CARDARELLI ANGELO	28.335
3274	UNION BANCAIRE PRIVEE EUROPE SA		CARDARELLI ANGELO	1.034.875
2436	UNION GENERALE DE RETRAITE DES CADRES		CARDARELLI ANGELO	1.778
2434	UNION GENERALE DE RETRAITE/REPARTIT.		CARDARELLI ANGELO	26.259
272	UNIPENSION INVEST FMBA EUROPÆISKE AKTIER		CARDARELLI ANGELO	380.668
2637	UNISUPER		CARDARELLI ANGELO	45.641
1838	UNIT NAT RELIEF AND WORKS AG FOR PALEST REF IN THE NEAR EAST		CARDARELLI ANGELO	12.430

ASSEMBLEA ORDINARIA 12 MAGGIO 2016

Segreteria Societaria - Ufficio Titoli



81 507/10/13

Unica convocazione

Esito della votazione sul punto 1

**Bilancio di esercizio al 31 dicembre 2015 di Eni S.p.A. Deliberazioni relative.
Presentazione Bilancio consolidato al 31 dicembre 2015. Relazioni degli
Amministratori, del Collegio Sindacale e della Società di revisione**

Elenco Favorevoli

SCHEDA	VPC	NOMINATIVO AZIONISTA	DELEGATO	NUMERO DI AZIONI TOTALE
1799		UNITED FOOD AND COMM WORK UNION LOCAL 152 RET MEAT PENS PL	CARDARELLI ANGELO	17.488
1835		UNITED NATIONS, ON BEHALF OF UNITED NATIONS UNIVERSITY END F	CARDARELLI ANGELO	36.000
700		UNITED TECHNOLOGIES CORP. MASTER RETIREMENT TR	CARDARELLI ANGELO	46.266
701		UNITED TECHNOLOGIES CORP. MASTER RETIREMENT TR	CARDARELLI ANGELO	77.025
984		UNITED TECHNOLOGIES CORPORATION EMPLOYEE SAVINGS PLAN	CARDARELLI ANGELO	171.442
784		UNIVERS CNP 1	CARDARELLI ANGELO	121.348
1566		UNIVERSAL INVESTMENT FUNDS	CARDARELLI ANGELO	62.600
355		UNIVERSAL SHIPOWNERS MARINE INSURANCE ASSOCIATION LIMITED	CARDARELLI ANGELO	16.894
2742		UNIVERSE THE CMI GLOBAL NETWORK FUND	CARDARELLI ANGELO	475.846
3238		UNIVERSITIES SUPERANNUATION SCHEME	CARDARELLI ANGELO	3.600.000
3239		UNIVERSITIES SUPERANNUATION SCHEME	CARDARELLI ANGELO	496.000
699		UNIVERSITY OF PITTSBURGH MEDICAL CENTER SYSTE	CARDARELLI ANGELO	32.136
2098		UNIVEST	CARDARELLI ANGELO	89.377
639		UPMC BASIC RETIREMENT PLAN MASTER TRUST	CARDARELLI ANGELO	18.435
696		UPS GROUP TRUST	CARDARELLI ANGELO	40.365
697		UPS GROUP TRUST	CARDARELLI ANGELO	16.092
900		US RETIREMENT TRUST	CARDARELLI ANGELO	4.192
926		USAA INTERNATIONAL FUND	CARDARELLI ANGELO	979.258
927		USAA INTERNATIONAL FUND	CARDARELLI ANGELO	491.087
1987		UTAH STATE RETIREMENT SYSTEMS	CARDARELLI ANGELO	370.368
224		VALERO ENERGY CORPORATION PENSION PLAN	CARDARELLI ANGELO	152.918
126		VALIANT AKTIEN EUROP	CARDARELLI ANGELO	45.689
1527		VALIC COMPANY I - FOREIGN VALUE FUND	CARDARELLI ANGELO	524.979

Handwritten signature/initials
Handwritten mark

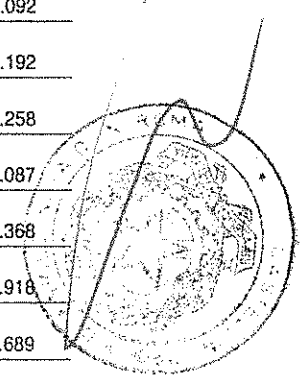

ASSEMBLEA ORDINARIA

81607 *Italy* 12 MAGGIO 2016

Segreteria Societaria - Ufficio Titoli



Unica convocazione

Esito della votazione sul punto 1

**Bilancio di esercizio al 31 dicembre 2015 di Eni S.p.A. Deliberazioni relative.
Presentazione Bilancio consolidato al 31 dicembre 2015. Relazioni degli
Amministratori, del Collegio Sindacale e della Società di revisione**

Elenco Favorevoli

SCHEDA	VPC	NOMINATIVO AZIONISTA	DELEGATO	NUMERO DI AZIONI TOTALE
1529		VALIC COMPANY I - GLOBAL STRATEGY FUND	CARDARELLI ANGELO	177.112
1526		VALIC COMPANY I - INTERNATIONAL EQUITIES FUND	CARDARELLI ANGELO	192.018
1528		VALIC COMPANY I-INTERNATIONAL GROWTH I FUND	CARDARELLI ANGELO	57.014
2697		VALOR ACTIONS	CARDARELLI ANGELO	40.000
1854		VALUEQUEST PARTNERS LLC	CARDARELLI ANGELO	16.695
1988		VAN ANDEL INSTITUTE	CARDARELLI ANGELO	23.938
1280		VANGUARD DEVEL ALL-CAP EX NORTH AMERICA EQT IND POOLED FUND	CARDARELLI ANGELO	4.185
2368		VANGUARD DEVELOPED MARKETS INDEX FUND	CARDARELLI ANGELO	9.420.248
2390		VANGUARD ENERGY FUND	CARDARELLI ANGELO	235.939
2367		VANGUARD EUROPEAN STOCK INDEX FUND	CARDARELLI ANGELO	5.411.220
2983		VANGUARD FID COMPANY EUROPEAN STOCK INDE	CARDARELLI ANGELO	154.009
2389		VANGUARD FTSE ALL-WORLD EX US INDEX FUND	CARDARELLI ANGELO	3.361.138
1279		VANGUARD FTSE DEVELOPED ALL CAP EX NORTH AMERICA INDEX ETF	CARDARELLI ANGELO	7.354
1278		VANGUARD FTSE DEVELOPED EUROPE ALL CAP INDEX ETF	CARDARELLI ANGELO	25.347
1283		VANGUARD FTSE DEVELOPED EUROPE INDEX ETF	CARDARELLI ANGELO	4.360
2398		VANGUARD FUNDS PLC	CARDARELLI ANGELO	65.566
2404		VANGUARD FUNDS PLC	CARDARELLI ANGELO	53.762
2405		VANGUARD FUNDS PLC	CARDARELLI ANGELO	167.666
2414		VANGUARD FUNDS PLC	CARDARELLI ANGELO	106.995
2415		VANGUARD FUNDS PLC	CARDARELLI ANGELO	4.389
411		VANGUARD INTERNATIONAL HIGH DIVIDEND YIELD INDEX FUND	CARDARELLI ANGELO	10.216
2889		VANGUARD INTERNATIONAL SHARE INDEX FUND	CARDARELLI ANGELO	741.486
1724		VANGUARD INV F ICVC-VANGUARD FTSE DEV EUROPE EX-UK EQ INDEX F	CARDARELLI ANGELO	566.481

ASSEMBLEA ORDINARIA

12 MAGGIO 2016

Segreteria Societaria - Ufficio Titoli

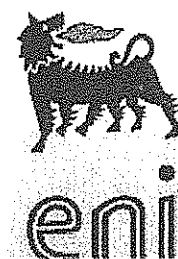

81607/1015

[Handwritten signature]

Unica convocazione

Esito della votazione sul punto 1

**Bilancio di esercizio al 31 dicembre 2015 di Eni S.p.A. Deliberazioni relative.
Presentazione Bilancio consolidato al 31 dicembre 2015. Relazioni degli
Amministratori, del Collegio Sindacale e della Società di revisione**

Elenco Favorevoli

SCHEDA	VPC	NOMINATIVO AZIONISTA	DELEGATO	NUMERO DI AZIONI TOTALE
1723		VANGUARD INV FDS ICVC-VANG FTSE DEV WOR LD EX - UK EQT IND FD	CARDARELLI ANGELO	238.802
2788		VANGUARD INVESTMENT SERIES, PLC	CARDARELLI ANGELO	2
2789		VANGUARD INVESTMENT SERIES, PLC	CARDARELLI ANGELO	122.652
2790		VANGUARD INVESTMENT SERIES, PLC	CARDARELLI ANGELO	108.549
2791		VANGUARD INVESTMENT SERIES, PLC	CARDARELLI ANGELO	17.806
1282		VANGUARD INVESTMENTS COMMON CONTRACTUAL FUND	CARDARELLI ANGELO	68.917
1284		VANGUARD INVESTMENTS COMMON CONTRACTUAL FUND	CARDARELLI ANGELO	49.038
1285		VANGUARD INVESTMENTS COMMON CONTRACTUAL FUND	CARDARELLI ANGELO	17.781
1281		VANGUARD INVESTMENTS II COMMON CONTRACTUAL FUND	CARDARELLI ANGELO	49.878
2980		VANGUARD TOTAL INTERNATIONAL STOCK INDEX	CARDARELLI ANGELO	25.807.600
2387		VANGUARD TOTAL WORLD STOCK INDEX FUND	CARDARELLI ANGELO	499.743
2954		VANTAGEPOINT INTERNATIONAL FUND	CARDARELLI ANGELO	914.195
2929		VANTAGEPOINT OVERSEAS EQUITY INDEX FUND	CARDARELLI ANGELO	84.408
3037		VAR INSURANCE PRODUCTS FUND OVERSEAS POR	CARDARELLI ANGELO	169.000
3116		VARIABLE PORTFOLIO-DFA INTER.VALUE FUND	CARDARELLI ANGELO	826.848
724		VEBA PARTNERSHIP N LP .	CARDARELLI ANGELO	54.419
2084		VERDIPAPIRFONDET KLP AKSJEEUROPA INDEKS 1	CARDARELLI ANGELO	197.620
2083		VERDIPAPIRFONDET KLP AKSJEGLOBAL INDEX 1	CARDARELLI ANGELO	308.362
3122		VERMONT PENSION INVESTMENT COMMITTE	CARDARELLI ANGELO	230.256
225		VICTORIAN SUPERANNUATION FUND	CARDARELLI ANGELO	139.207
231		VICTORIAN SUPERANNUATION FUND	CARDARELLI ANGELO	46.071
75		VICTORY CAPITAL INTERNATIONAL COLLECTIVE INVESTMENT TRUST	CARDARELLI ANGELO	7.818
104		VICTORY GLOBAL EQUITY FUND	CARDARELLI ANGELO	10.001

[Handwritten signature]

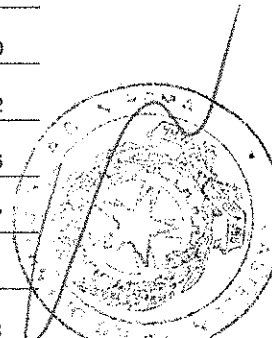

ASSEMBLEA ORDINARIA

81607/1016 12 MAGGIO 2016

Segreteria Societaria - Ufficio Titoli



eni

Unica convocazione

Esito della votazione sul punto 1

Bilancio di esercizio al 31 dicembre 2015 di Eni S.p.A. Deliberazioni relative.
Presentazione Bilancio consolidato al 31 dicembre 2015. Relazioni degli
Amministratori, del Collegio Sindacale e della Società di revisione

Elenco Favorevoli

SCHEDA	VPC	NOMINATIVO AZIONISTA	DELEGATO	NUMERO DI AZIONI TOTALE
810		VILLIERS ALTO	CARDARELLI ANGELO	35.033
703		VIRGINIA RETIREMENT SYSTEM .	CARDARELLI ANGELO	26.566
704		VIRGINIA RETIREMENT SYSTEM .	CARDARELLI ANGELO	260.836
705		VIRGINIA RETIREMENT SYSTEM .	CARDARELLI ANGELO	356.793
761		VOCATION MARCHE ARIANESPACE CONSEIL DE SURVEILLANCE DU FCP	CARDARELLI ANGELO	2.625
1774		VOL EMPL BEN ASS OF THE NON-REPR EMPL OF SOUT CAL EDISON CO	CARDARELLI ANGELO	4.325
271		VOYA EURO STOXX 50INDEX PORTFOLIO	CARDARELLI ANGELO	567.637
238		VOYA GLOBAL EQUITY DIVIDEND ANDPREMIUM OPPORTUNITY FUND	CARDARELLI ANGELO	532.987
243		VOYA INTERNATIONAL HIGH DIVIDEND EQUITY INCOME FUND	CARDARELLI ANGELO	9.922
264		VOYA INTERNATIONAL INDEX PORTFOLIO	CARDARELLI ANGELO	267.724
256		VY TEMPLETON FOREIGN EQUITY PORTFOLIO	CARDARELLI ANGELO	680.187
221		VY TEMPLETON GLOBAL GROWTH PORTFOLIO	CARDARELLI ANGELO	115.691
3183		Veritas Global Equity Income Fund	CARDARELLI ANGELO	4.220.000
1304		WASHINGTON STATE INVESTMENT BOARD	CARDARELLI ANGELO	1.004.969
1305		WASHINGTON STATE INVESTMENT BOARD	CARDARELLI ANGELO	2.244.064
1306		WASHINGTON STATE INVESTMENT BOARD	CARDARELLI ANGELO	72.313
2417		WELL TC NAM CONTRARIAN VALUE PORTFOLIO	CARDARELLI ANGELO	113.448
2408		WELLING TRUST COMP NAT ASSOC MULTIP COMM	CARDARELLI ANGELO	1.541.734
76		WELLINGTON GL RES EQ PTFO ATTN SIJIA CHEN MACQUARIE INVESTMENT MANAGEMENT LIMITED	CARDARELLI ANGELO	7.177
2383		WELLINGTON MANAGEMENT PORTFOLIOS (LUX) IV SICAV-FIS-GL MULT-AS TARRET PF	CARDARELLI ANGELO	6.649
2380		WELLINGTON MANAGNT PORTFOLIOS GLOB RESEA	CARDARELLI ANGELO	61.226
1573		WELLINGTON MGMT PTF KY-DIVERSIFIED INFLATION HEDGES PTF-Q INV	CARDARELLI ANGELO	158.546
1290		WELLINGTON TR CO, NAT ASS M. COMM.TR.FDS TR GL. NAT RES. PTF	CARDARELLI ANGELO	533.931

ASSEMBLEA ORDINARIA

12 MAGGIO 2016

Segreteria Societaria - Ufficio Titoli



eni

81607/104

C. Cardarelli

Unica convocazione

Esito della votazione sul punto 1

**Bilancio di esercizio al 31 dicembre 2015 di Eni S.p.A. Deliberazioni relative.
Presentazione Bilancio consolidato al 31 dicembre 2015. Relazioni degli
Amministratori, del Collegio Sindacale e della Società di revisione**

Elenco Favorevoli

SCHEDA	VPC	NOMINATIVO AZIONISTA	DELEGATO	NUMERO DI AZIONI TOTALE
2396		WELLINGTON TRUST COMP COMM TRUST INT OPP	CARDARELLI ANGELO	152.532
564		WELLMARK INC.	CARDARELLI ANGELO	45.238
565		WELLMARK OF SOUTH DAKOTA INC.	CARDARELLI ANGELO	20.920
1298		WELLS FARGO ADVANTAGE INFLATION-PROTECTED BOND PORTFOLIO	CARDARELLI ANGELO	32.056
1300		WELLS FARGO ALTERNATIVE STRATEGIES FUND	CARDARELLI ANGELO	7.302
278		WELLS FARGO AND CO CASH BALANCEPLAN	CARDARELLI ANGELO	345.219
279		WELLS FARGO AND CO CASH BALANCEPLAN	CARDARELLI ANGELO	32.497
1293		WELLS FARGO BK DECL OF TR EST INV FUNDS FOR EMPLOYEE BEN TR	CARDARELLI ANGELO	61.601
1295		WELLS FARGO DIVERSIFIED INTERNATIONAL FUND	CARDARELLI ANGELO	59.912
887		WELLS FARGO GLOBAL DIVIDEND OPPORTUNITY FUND	CARDARELLI ANGELO	50.000
1299		WELLS FARGO GLOBAL LONG/SHORT FUND	CARDARELLI ANGELO	10.356
1296		WELLS FARGO INTERNATIONAL EQUITY FUND	CARDARELLI ANGELO	706.721
1294		WELLS FARGO VT INTERNATIONAL EQUITY FUND	CARDARELLI ANGELO	520.255
1297		WELLS FARGO MASTER TRUST DIVERSIFIED STOCK PORTFOLIO	CARDARELLI ANGELO	247.150
3184		WEST MIDLANDS METROPOLITAN AUT PENS FD	CARDARELLI ANGELO	550.586
3185		WEST YORKSHIRE PENSION FUND	CARDARELLI ANGELO	500.000
1482		WESTERN METAL INDUSTRY PENSION	CARDARELLI ANGELO	60.342
3142		WESTMINSTER ARTEMIS GLOBAL ENERGY FUND	CARDARELLI ANGELO	106.581
1738		WESTPAC INTERNATIONAL SHARE INDEX TRUST	CARDARELLI ANGELO	123.345
823		WHEATON COLLEGE TRUST COMPANY, N.A AS TRUSTEE OF THE WHEATON	CARDARELLI ANGELO	45.425
2024		WHEELS COMMON INVESTMENT FUND	CARDARELLI ANGELO	73.789
2025		WHEELS COMMON INVESTMENT FUND	CARDARELLI ANGELO	54.970
2624		WHOLESALE GLOBAL EQUITY INDEX FUND	CARDARELLI ANGELO	14.843

C. Cardarelli

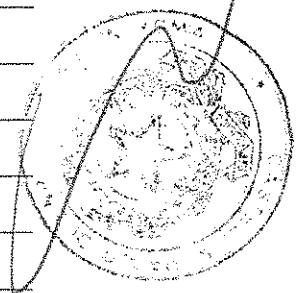

ASSEMBLEA ORDINARIA

81607/16/18 12 MAGGIO 2016

Segreteria Societaria - Ufficio Titoli



eni

Unica convocazione

Esito della votazione sul punto 1

Bilancio di esercizio al 31 dicembre 2015 di Eni S.p.A. Deliberazioni relative.
Presentazione Bilancio consolidato al 31 dicembre 2015. Relazioni degli
Amministratori, del Collegio Sindacale e della Società di revisione

Elenco Favorevoli

SCHEDA	VPC	NOMINATIVO AZIONISTA	DELEGATO	NUMERO DI AZIONI TOTALE
3219		WHOLESALE UNIT TRUST GLOBAL SHARES F 3	CARDARELLI ANGELO	13.294
2635		WHOLESALE UNIT TRUST MSCI GLOB INDEX SHS	CARDARELLI ANGELO	63.144
867		WILLIAM BEAUMONT HOSPITAL	CARDARELLI ANGELO	7.980
866		WILLIAM BEAUMONT HOSPITAL EMPLOYEES' RETIREMENT PLAN	CARDARELLI ANGELO	14.068
303		WILMINGTON MULTI-MANAGER INTERNATIONAL FUND	CARDARELLI ANGELO	12.627
1302		WILMINGTON TRUST RETIREMENT AND INST SER CO COLLECTIVE INV TR	CARDARELLI ANGELO	136.400
361		WILSHIRE INSTITUTIONAL MASTER FUND SPC	CARDARELLI ANGELO	2.300
1819		WINDWISE SEEDING FUND SPC, LTD	CARDARELLI ANGELO	7.117
1777		WISCONSIN PUBLIC SERVICE CORPORATION MASTER WELFARE BENEFIT TR	CARDARELLI ANGELO	31.900
1309		WISDOMTREE DEFA EQUITY INCOME FUND	CARDARELLI ANGELO	242.479
1307		WISDOMTREE DYNAMIC CURRENCY HEDGED EUROPE EQUITY FUND	CARDARELLI ANGELO	9.714
1308		WISDOMTREE DYNAMIC CURRENCY HEDGED INTRNL EQUITY FUND	CARDARELLI ANGELO	122.051
1316		WISDOMTREE EUROPE LOCAL RECOVERY FUND	CARDARELLI ANGELO	2.145
1317		WISDOMTREE GLOBAL EX-U.S. HEDGED DIVIDEND FUND	CARDARELLI ANGELO	1.500
1311		WISDOMTREE GLOBAL HIGH DIVIDEND FUND	CARDARELLI ANGELO	17.623
1312		WISDOMTREE GLOBAL NATURAL RESOURCES FUND	CARDARELLI ANGELO	18.217
1313		WISDOMTREE INTERNATIONAL DIVIDEND EX-FINANCIALS FUND	CARDARELLI ANGELO	306.786
1310		WISDOMTREE INTERNATIONAL EQUITY FUND	CARDARELLI ANGELO	332.123
1315		WISDOMTREE INTERNATIONAL HEDGED EQUITY FUND	CARDARELLI ANGELO	2.378
1314		WISDOMTREE INTERNATIONAL LARGE CAP DIVIDEND FUND	CARDARELLI ANGELO	271.581
1301		WISDOMTREE ISSUER PUBLIC LIMITED COMPANY	CARDARELLI ANGELO	61.526
2505		WITAN INVESTMENT TRUST PLC	CARDARELLI ANGELO	49.200
2506		WITAN INVESTMENT TRUST PLC	CARDARELLI ANGELO	229.000

ASSEMBLEA ORDINARIA 12 MAGGIO 2016

Segreteria Societaria - Ufficio Titoli



eni

81607/1019

2

Unica convocazione

Esito della votazione sul punto 1

**Bilancio di esercizio al 31 dicembre 2015 di Eni S.p.A. Deliberazioni relative.
Presentazione Bilancio consolidato al 31 dicembre 2015. Relazioni degli
Amministratori, del Collegio Sindacale e della Società di revisione**

Elenco Favorevoli

SCHEDA	VPC NOMINATIVO AZIONISTA	DELEGATO	NUMERO DI AZIONI TOTALE
1880	WM KNIGHT	CARDARELLI ANGELO	7.729
260	WM POOL EQUITIES TRUST NO 20	CARDARELLI ANGELO	267.975
316	WM POOL EQUITIES TRUST NO. 40	CARDARELLI ANGELO	2.206
407	WM POOL-EQUITIES TRUST NO. 75	CARDARELLI ANGELO	73.407
1460	WORLD ALPHA TILTS NON-LENDABLE FUND B	CARDARELLI ANGELO	1.369
1605	WORLD INDEX OLUS SECURITIES LENDING COMMON TRUST FUND	CARDARELLI ANGELO	35.164
2351	WORLDVIEW INVESTMENT FUND EUROPE CORE EQUITY FUND	CARDARELLI ANGELO	63.600
2870	WSSP INTERNATIONAL EQUITIES TRUST	CARDARELLI ANGELO	30.986
1829	WYOMING RETIREMENT SYSTEM	CARDARELLI ANGELO	48.336
1830	WYOMING RETIREMENT SYSTEM	CARDARELLI ANGELO	35.320
1831	WYOMING RETIREMENT SYSTEM	CARDARELLI ANGELO	14.831
1832	WYOMING RETIREMENT SYSTEM	CARDARELLI ANGELO	43.713
2619	henderson gartmore fund	CARDARELLI ANGELO	2.252.304
3300	MINISTERO DELL'ECONOMIA E DELLE FINANZE DI STEFANO STEFANO		157.552.137
2305	BANK OF NEW YORK MELLON ADR D.	CARDARELLI ANGELO	43.624.688

2

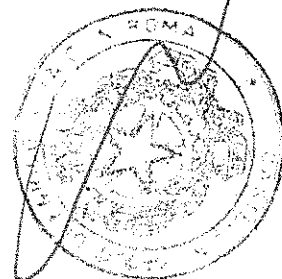

ASSEMBLEA ORDINARIA

81607/2020 12 MAGGIO 2016

Segreteria Societaria - Ufficio Titoli



eni

Unica convocazione

Esito della votazione sul punto 1

Bilancio di esercizio al 31 dicembre 2015 di Eni S.p.A. Deliberazioni relative.
Presentazione Bilancio consolidato al 31 dicembre 2015. Relazioni degli
Amministratori, del Collegio Sindacale e della Società di revisione

Elenco Favorevoli

SCHEDA VPC NOMINATIVO AZIONISTA

DELEGATO

NUMERO DI AZIONI
TOTALE

Riepilogo favorevoli

TOTALE FAVOREVOLI	n°	3.142 azionisti per n°	2.142.940.036 Azioni
di cui			99,98660 % delle azioni presenti
IN PROPRIO	n°	23 azionisti per n°	174.131 Azioni
			0,00812 % delle azioni presenti
PER DELEGA	n°	3.119 azionisti per n°	2.142.765.905 Azioni
			99,97848 % delle azioni presenti

ASSEMBLEA ORDINARIA 12 MAGGIO 2016

Segreteria Societaria - Ufficio Titoli

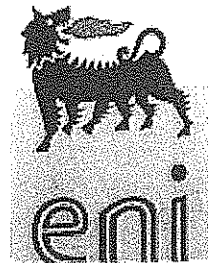

81607/1021

3

2

Unica convocazione

Esito della votazione sul punto 1

**Bilancio di esercizio al 31 dicembre 2015 di Eni S.p.A. Deliberazioni relative.
Presentazione Bilancio consolidato al 31 dicembre 2015. Relazioni degli
Amministratori, del Collegio Sindacale e della Società di revisione**

Elenco Contrari

SCHEDA	NOMINATIVO AZIONISTA	DELEGATO	NUMERO DI AZIONI TOTALE
2104	MARINO TOMMASO		1
3246	REGIME DE RETRAITE DE L'UNIVER DU QUEBEC	CARDARELLI ANGELO	31.518
2305	BANK OF NEW YORK MELLON ADR D.	CARDARELLI ANGELO	49.668

Riepilogo Contrari

TOTALE CONTRARI	n°	3 azionisti per n°	81.187 Azioni 0,00379 % delle azioni presenti
di cui			
IN PROPRIO	n°	1 azionisti per n°	1 Azioni 0,00000 % delle azioni presenti
PER DELEGA	n°	2 azionisti per n°	81.186 Azioni 0,00379 % delle azioni presenti

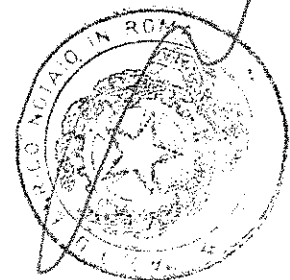

ASSEMBLEA ORDINARIA

81607/1022 12 MAGGIO 2016

Segreteria Societaria - Ufficio Titoli

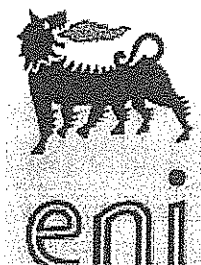

Unica convocazione

Esito della votazione sul punto 1

Bilancio di esercizio al 31 dicembre 2015 di Eni S.p.A. Deliberazioni relative.
Presentazione Bilancio consolidato al 31 dicembre 2015. Relazioni degli
Amministratori, del Collegio Sindacale e della Società di revisione

Elenco Astenuti

SCHEDA	NOMINATIVO AZIONISTA	DELEGATO	NUMERO DI AZIONI TOTALE
2321	FAZIO ALFREDO		2
2340	FONDAZIONE CULTURALE RESPONSABILITA' ETICA		
	MEGGIOLARO MAURO		80
2843	TEACHERS' RETIREMENT SYSTEM OF THE CITY OF NEW YORK		
	CARDARELLI ANGELO		72.892
2305	BANK OF NEW YORK MELLON ADR D.		
	CARDARELLI ANGELO		130.892

Riepilogo Astenuti

TOTALE ASTENUTI	n°	4 azionisti per n°	203.866 Azioni
di cui			0,00951 % delle azioni presenti
IN PROPRIO	n°	1 azionisti per n°	2 Azioni
			0,00000 % delle azioni presenti
PER DELEGA	n°	3 azionisti per n°	203.864 Azioni
			0,00951 % delle azioni presenti

ASSEMBLEA ORDINARIA 12 MAGGIO 2016

Segreteria Societaria - Ufficio Titoli



81607/10/13

Unica convocazione

Esito della votazione sul punto 1

Bilancio di esercizio al 31 dicembre 2015 di Eni S.p.A. Deliberazioni relative.
Presentazione Bilancio consolidato al 31 dicembre 2015. Relazioni degli
Amministratori, del Collegio Sindacale e della Società di revisione

Elenco Non Votanti

SCHEDA	NOMINATIVO AZIONISTA	DELEGATO	NUMERO DI AZIONI TOTALE
2226	NOTARFONZO ARNALDO		2.100

Riepilogo Non votanti

TOTALE NON VOTANTI	n°	1 azionisti per n°	2.100 Azioni 0,00010 % delle azioni presenti
di cui			
IN PROPRIO	n°	1 azionisti per n°	2.100 Azioni 0,00010 % delle azioni presenti
PER DELEGA	n°	0 azionisti per n°	0 Azioni 0,00000 % delle azioni presenti

Notary Eni

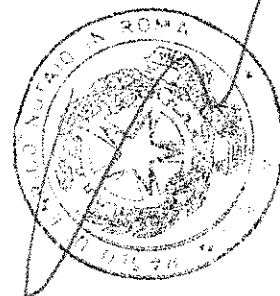

PAGINA ANNULLATA

ASSEMBLEA ORDINARIA 12 MAGGIO 2016

Segreteria Societaria - Ufficio Titoli



eni

Unica convocazione

Esito della votazione sul punto 2

ALLEGATO " I "
ROGITO 22006

Attribuzione dell'utile di esercizio

81607/1026

Azionisti Presenti

In proprio	n°	26	per n°	176.234 Azioni	0,00 % del capitale sociale
Per delega	n°	3.122	per n°	2.143.050.955 Azioni	58,97 % del capitale sociale
TOTALE PRESENTI	n°	3.148	per n°	2.143.227.189 Azioni	58,97 % del capitale sociale

Quorum per approvazione

n° 1.071.613.595 Voti favorevoli
(Pari a 1/2 delle Azioni Presenti + 1)

Esito Votazione

FAVOREVOLI	n°	3.137	azionisti per n°	2.141.183.951 Azioni	99,90467 % delle azioni presenti
CONTRARI	n°	10	azionisti per n°	1.922.844 Azioni	0,08972 % delle azioni presenti
ASTENUTI E NON VOTANTI	n°	3	azionisti per n°	120.394 Azioni	0,00562 % delle azioni presenti

La Proposta è approvata

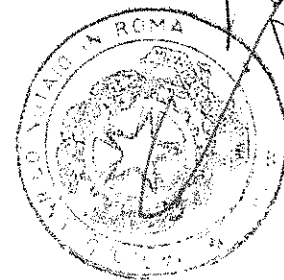

Nota: voti disgiunti addizionali n°

2

12/05/2016

PAGINA ANNULLATA

ASSEMBLEA ORDINARIA 12 MAGGIO 2016

Segreteria Societaria - Ufficio Titoli



eni

Unica convocazione

Esito della votazione sul punto 2

Attribuzione dell'utile di esercizio

81607/1025

Elenco Favorevoli

SCHEDA VPC	NOMINATIVO AZIONISTA	DELEGATO	NUMERO DI AZIONI TOTALE
2326	ADINOLFI VINCENZO		70.000
16	AMBRUZZI DANIELA		275
3301	BAIETTA MAURIZIO		962
113	BATTAGLIA SERGIO		15.500
2102	BELLINO ROCI PIERCARLO		10.000
15	BUCCINO VINCENZO		4.127
2218	CAPUTO RITA		250
7	CHIURAZZI LUIGI		3.000
2332	CICERONE STEFANO PIETRO		300
2327	COLLEONI ANGELO		2.510
3304	DI TEODORO VITO		100
105	DORI CARLO		1.330
2321	FAZIO ALFREDO		2
114	GARIZZO EMIDIA		41.500
2224	IADICICCO ANTONIO		2.000
850	METELKA LUCIANO		5.000
2222	NACCI VITO ROCCO		1
2106	PAVESI ALBERTO		1
2318	PEDERSOLI LANFRANCO		1.700
2227	PONTI GIOVANNI		5.065
2330	SCORSONE MIRKO		10
847	TERRONI PIERRE		6.200

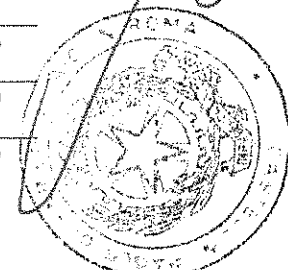

ASSEMBLEA ORDINARIA

81607/1026 12 MAGGIO 2016

Segreteria Societaria - Ufficio Titoli



eni

Unica convocazione

Esito della votazione sul punto 2

Attribuzione dell'utile di esercizio

Elenco Favorevoli

SCHEDA	VPC	NOMINATIVO AZIONISTA	DELEGATO	NUMERO DI AZIONI TOTALE
2346		VAVALLI VITO UMBERTO		3.800
2219		ZACCAGNINO RAFFAELE		500
106		ROSATI GIUSEPPINA	DORI CARLO	1.330
2101		ALLIO GERMANA	BELLINO ROCI MAURO	100
2228		INARCASSA - CASSA NAZIONALE DI PREVIDENZA ED ASSISTENZA PER GIORGIO GIANCARLO		4.788.980
2342		HC RENTE SIEMENS FONDS INVEST GMBH MEGGIOLARO MAURO		25.461
2341		SIEMENS BSAV BALANCED SIEMENS FONDS INVEST GMBH MEGGIOLARO MAURO		27.794
2343		SIEMENS-FONDS SIEMENS-RENTE SIEMENS FONDS INVEST GMBH MEGGIOLARO MAURO		540.828
2344		SIEMENS-FONDS SPT MM SIEMENS FONDS INVEST GMBH MEGGIOLARO MAURO		138.205
3293		CASSA DEPOSITI E PRESTITI SPA	RAMUNDO FABRIZIO	936.179.478
2333		CICERONE CORRADO	CICERONE STEFANO PIETRO	400
2334		MELIS LICIA	CICERONE STEFANO PIETRO	400
115		ROSSI PAOLO	ROSSI AGOSTINO	4.830
2103		ANGELINI SANTA	COLLEONI ANGELO	2.517
116		ROSSETTI RAUL FERNANDO	TREVISAN DARIO	800
2		ASS.NE CASSA NAZ.DI PREV.E ASSISTENZA A FAV. DEI BIANCO GIUSEPPE		971.965
825		ALLEANZA ASSICURAZIONI SPA	CARDINALI LUIGI	715.000
826		ALLEANZA ASSICURAZIONI SPA	CARDINALI LUIGI	861.700
827		ALLEANZA ASSICURAZIONI SPA	CARDINALI LUIGI	424.290
828		ALLEANZA ASSICURAZIONI SPA	CARDINALI LUIGI	35.000
829		ALLEANZA ASSICURAZIONI SPA	CARDINALI LUIGI	69.219
830		ALLEANZA ASSICURAZIONI SPA	CARDINALI LUIGI	36.900
831		ALLEANZA ASSICURAZIONI SPA	CARDINALI LUIGI	4.250

ASSEMBLEA ORDINARIA 12 MAGGIO 2016

Segreteria Societaria - Ufficio Titoli



eni

Unica convocazione

Esito della votazione sul punto 2

Attribuzione dell'utile di esercizio

81607/1027

Mancini

Elenco Favorevoli

SCHEDA VPC	NOMINATIVO AZIONISTA	DELEGATO	NUMERO DI AZIONI TOTALE
3288	GENERTELLIFE SPA	CARDINALI LUIGI	1.469.614
3287	Generali Italia SpA	CARDINALI LUIGI	2.241.867
854	STAMATI ANTONIETTA	SPINA ROSARIO	1.350
2316	F.DO GESTIELLE DUAL BRAND EQUITY 30 DI ALETTI GESTIELLE SGR TREVISAN DARIO		45.000
2308	FONDO GESTIELLE ABSOLUTE RETURN DI ALETTI GESTIELLE S.G.R. S TREVISAN DARIO		150.000
2313	FONDO GESTIELLE CEDOLA DUAL BRAND DI ALETTI GESTIELLE SGR SP TREVISAN DARIO		75.000
2312	FONDO GESTIELLE CEDOLA MULTI ASSET II DI ALETTI GESTIELLE SG TREVISAN DARIO		80.000
2314	FONDO GESTIELLE CEDOLA MULTI TARGET II D ALETTI GESTIELLE SG TREVISAN DARIO		50.000
2310	FONDO GESTIELLE CEDOLA MULTIASET DI ALETTI GESTIELLE SGR SP TREVISAN DARIO		104.000
2315	FONDO GESTIELLE OBIETTIVO EUROPA DI ALETTI GESTIELLE S.G.R. TREVISAN DARIO		50.000
2311	FONDO GESTIELLE OBIETTIVO INTERNAZIONALE DI ALETTI GESTIELLE TREVISAN DARIO		100.000
2306	FONDO GESTIELLE OBIETTIVO ITALIA DI ALETTI GESTIELLE S.G.R. TREVISAN DARIO		750.000
2309	FONDO GESTIELLE PROFILO CEDOLA DI ALETTI GESTIELLE SGR SPA TREVISAN DARIO		108.000
2317	FONDO VOLTERRA ABSOLUTE RETURN DI ALETTI GESTIELLE S.G.R. S. TREVISAN DARIO		2.000
2307	GESTIELLE CEDOLA ITALY OPPORTUNITY DI ALETTI GESTIELLE SGR TREVISAN DARIO		400.000
2638	1262 FCP BEHR FRANCE	CARDARELLI ANGELO	136
3132	1290 FUNDS - 1290 GLOBAL EQUITY MANAGERS FUND	CARDARELLI ANGELO	6.531
2639	1327 FCP BQUE SCALBERT DUPONT	CARDARELLI ANGELO	6.000
2676	1448 FCPE GE FACTOFrance	CARDARELLI ANGELO	3.000
2684	1495 FCP CONTINENTAL	CARDARELLI ANGELO	850
2743	1741 ASSET MANAGEMENT FUNDS SICAV	CARDARELLI ANGELO	44.700
1927	1999 VOL EMPL BEN ASS NON-REPR EMPL OF SOUT CAL EDISON CO	CARDARELLI ANGELO	7.920
2075	7IM AAP ADVENTUROUS FUND	CARDARELLI ANGELO	21.348

Mancini

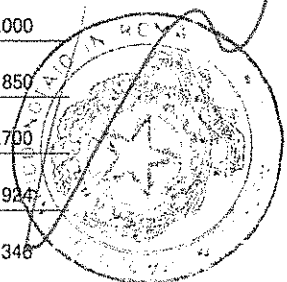

ASSEMBLEA ORDINARIA

81607/1028 12 MAGGIO 2016

Segreteria Societaria - Ufficio Titoli



eni

Unica convocazione

Esito della votazione sul punto 2

Attribuzione dell'utile di esercizio

Elenco Favorevoli

SCHEMA	VPC	NOMINATIVO AZIONISTA	DELEGATO	NUMERO DI AZIONI TOTALE
2072		7IM AAP BALANCED FUND	CARDARELLI ANGELO	109.692
2071		7IM AAP INCOME FUND	CARDARELLI ANGELO	2.329
2073		7IM AAP MODERATELY ADVENTUROUS FUND	CARDARELLI ANGELO	70.828
2079		7IM AAP MODERATELY CAUTIOUS FUND	CARDARELLI ANGELO	32.440
2076		7IM ADVENTUROUS FUND	CARDARELLI ANGELO	8.325
2074		7IM BALANCED FUND	CARDARELLI ANGELO	26.386
2080		7IM EUROPEAN (EX UK) EQUITY VALUE FUND	CARDARELLI ANGELO	125.101
2077		7IM MODERATELY ADVENTUROUS FUND	CARDARELLI ANGELO	21.124
2078		7IM MODERATELY CAUTIOUS FUND	CARDARELLI ANGELO	7.122
208		A.A.-DEXIA ISR	CARDARELLI ANGELO	50.641
1957		A.I.DUPONT TESTAMENTARY TRUST	CARDARELLI ANGELO	63.700
765		AA AMUNDI ISR	CARDARELLI ANGELO	42.191
206		AA FORTIS TACTIQUE	CARDARELLI ANGELO	117.852
1669		ABBAY LIFE ASSURANCE COMPANY LIMITED	CARDARELLI ANGELO	27.123
1670		ABBAY LIFE ASSURANCE COMPANY LIMITED	CARDARELLI ANGELO	212.923
3218		ABERDEEN GLOBAL	CARDARELLI ANGELO	194.800
1708		ABERDEEN INV FUNDS UK ICVC II-ABERDEEN EUR EQ ENHANCED INDEXF	CARDARELLI ANGELO	43.742
3209		ABERDEEN INVESTMENT FUNDS ICVC	CARDARELLI ANGELO	84.900
1013		ABERDEEN NATURAL RESOURCES FUND	CARDARELLI ANGELO	39.600
3277		ABERDEEN SWISS FUNDS GLOBAL ENERGY EQUITY FUND	CARDARELLI ANGELO	13.740
1634		ABN AMRO MULTI-MANAGER FUNDS	CARDARELLI ANGELO	942.992
1635		ABN AMRO MULTI-MANAGER FUNDS	CARDARELLI ANGELO	1.150.625
1636		ABN AMRO MULTI-MANAGER FUNDS	CARDARELLI ANGELO	29.212

ASSEMBLEA ORDINARIA 12 MAGGIO 2016

Segreteria Societaria - Ufficio Titoli



eni

Unica convocazione

Esito della votazione sul punto 2

Attribuzione dell'utile di esercizio

81607/2029

Mazzoni

Elenco Favorevoli

SCHEDA	VPC	NOMINATIVO AZIONISTA	DELEGATO	NUMERO DI AZIONI TOTALE
2086		ABU DHABI RETIREMENT PENSIONS AND BENEFITS FUND	CARDARELLI ANGELO	202.346
376		ACHMEA PENSIOEN-EN LEVENSVZERKERINGEN N.V.	CARDARELLI ANGELO	13.391
374		ACHMEA REINSURANCE COMPANY N.V.	CARDARELLI ANGELO	6.787
370		ACHMEA SCHADEVERZEKERINGEN N.V.	CARDARELLI ANGELO	13.472
2643		ACM ACTIONS	CARDARELLI ANGELO	4.645
2642		ACM ACTIONS PLUS	CARDARELLI ANGELO	8.706
2232		ACMBERNSTEIN SICAV GLOBAL E	CARDARELLI ANGELO	3.665
1755		ACORN 1998 TRUST	CARDARELLI ANGELO	2.631
749		ACTIONS EURO CA-MF CREDIT AGRICOLE ASSET MANAGEMENT	CARDARELLI ANGELO	90.034
145		ACTIONS SELECTION MONDE	CARDARELLI ANGELO	40.000
3112		ACTIVE PORTFOLIOS MULTI MANAGER ALTERNAT	CARDARELLI ANGELO	323.826
1453		ACWI EX-US INDEX MASTER PORTFOLIO OF MASTER INVESTMENT PTF	CARDARELLI ANGELO	119.849
767		ADPACTIONS	CARDARELLI ANGELO	4.278
768		ADPARGNE	CARDARELLI ANGELO	4.927
2702		ADREA DIVERSIFIE FRANCHE COMTE	CARDARELLI ANGELO	2.526
2898		ADVANCE INTERNATIONAL SHARE INDEX FUND	CARDARELLI ANGELO	87.042
346		ADVANCED SERIES TRUST AST FRANKLIN TEMPLETON K2 GLOBAL ABSOLUTE	CARDARELLI ANGELO	5.520
330		ADVANCED SERIES TRUST AST GOLDMAN SACHS MULTI ASSET PORTFOLIO	CARDARELLI ANGELO	66.596
315		ADVANCED SERIES TRUST AST NEW DISCOVERY ASSET ALLOCATION PORTFOL	CARDARELLI ANGELO	67.200
317		ADVANCED SERIES TRUST-AST SCHROEDERS GLOBAL TACTICAL PORTFOLIO	CARDARELLI ANGELO	726.202
2416		ADVISOR MANAGED TRUST - TACTICAL OFFENSI	CARDARELLI ANGELO	23.912
37		AEGON CUSTODY B.V	CARDARELLI ANGELO	275.505
49		AEGON CUSTODY B.V	CARDARELLI ANGELO	85.041

ent

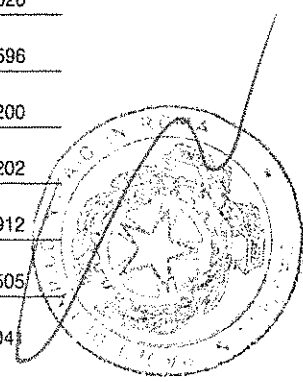

ASSEMBLEA ORDINARIA

81607/1030 12 MAGGIO 2016

Segreteria Societaria - Ufficio Titoli

**eni**

Unica convocazione

Esito della votazione sul punto 2

Attribuzione dell'utile di esercizio**Elenco Favorevoli**

SCHEDA	VPC	NOMINATIVO AZIONISTA	DELEGATO	NUMERO DI AZIONI TOTALE
64		AEGON GLOBAL FUNDS	CARDARELLI ANGELO	67.700
483		AGF ALL WORLD TAX ADVANTAGE GROUP LIMITED	CARDARELLI ANGELO	66.430
481		AGF EUROPEAN EQUITY FUND	CARDARELLI ANGELO	27.715
2524		AGI FONDS GRILLPARZER	CARDARELLI ANGELO	9.062
2490		AGIPI ACTIONS EUROPE	CARDARELLI ANGELO	389.361
808		AGIRA RETRAITE DIVERSIFIE	CARDARELLI ANGELO	29.734
819		AGIRA RETRAITE DIVERSIFIE	CARDARELLI ANGELO	63.000
750		AGRIPLAN EXPANSION FCPE CAES	CARDARELLI ANGELO	31.579
253		AK STEEL CORPORATION MASTER PENSION TRUST	CARDARELLI ANGELO	15.207
489		ALABAMA TRUST FUND	CARDARELLI ANGELO	75.600
1536		ALAMEDA COUNTY EMPLOYEES' RETIREMENT ASSOCIATION	CARDARELLI ANGELO	633.318
1537		ALAMEDA COUNTY EMPLOYEES' RETIREMENT ASSOCIATION	CARDARELLI ANGELO	60.059
232		ALAS INVESTMENT SERVICES LTD	CARDARELLI ANGELO	62.148
1188		ALASKA COMMON TRUST FUND	CARDARELLI ANGELO	70.885
945		ALASKA ELECTRICAL PENSION PLAN	CARDARELLI ANGELO	86.087
484		ALASKA PERMANENT FUND CORPORATION	CARDARELLI ANGELO	190.800
485		ALASKA PERMANENT FUND CORPORATION	CARDARELLI ANGELO	373.969
486		ALASKA PERMANENT FUND CORPORATION	CARDARELLI ANGELO	23.650
487		ALASKA PERMANENT FUND CORPORATION	CARDARELLI ANGELO	23.956
488		ALASKA PERMANENT FUND CORPORATION	CARDARELLI ANGELO	220.983
934		ALLIANCEBERNST VAR PROD SER F INC.ALLIANCER DYN ASSET ALL PTF	CARDARELLI ANGELO	15.444
929		ALLIANCEBERNSTEIN BOND F - ALLIANCEBERNSTEIN REAL AS STR	CARDARELLI ANGELO	8.990
933		ALLIANCEBERNSTEIN COLLECTIVE INVESTMENT TRUST SERIES	CARDARELLI ANGELO	639

ASSEMBLEA ORDINARIA 12 MAGGIO 2016

Segreteria Societaria - Ufficio Titoli



Unica convocazione

Esito della votazione sul punto 2

Attribuzione dell'utile di esercizio

81607/1031

M. M.

Elenco Favorevoli

SCHEDA	VPC NOMINATIVO AZIONISTA	DELEGATO	NUMERO DI AZIONI TOTALE
928	ALLIANCEBERNSTEIN GLOBAL RISK ALLOCATION FUND INC CARDARELLI ANGELO		7.149
1112	ALLIANCEBERNSTEIN INTERNATIONAL ALL-COUNTRY PASSIVE SERIES CARDARELLI ANGELO		36.973
728	ALLIANT TECHSYSTEMS INC.DEFINEDBENEFIT MASTER TRUST CARDARELLI ANGELO		49.624
2561	ALLIANZ FLEXI EURO BALANCE CARDARELLI ANGELO		125.761
2560	ALLIANZ FLEXI EURO DYNAMIK CARDARELLI ANGELO		49.691
2559	ALLIANZ FNDVOR 1947 1951 CARDARELLI ANGELO		186.901
2542	ALLIANZ GI FONDS D300 CARDARELLI ANGELO		52.983
2543	ALLIANZ GI FONDS PKM DEGUSSA CARDARELLI ANGELO		7.569
2538	ALLIANZ GI FONDS RANW II CARDARELLI ANGELO		72.030
950	ALLIANZ GLOBAL INV GMBH FOR ALLIANZGI-FONDS SFT2 CARDARELLI ANGELO		20.592
1258	ALLIANZ GLOBAL INV KAG MBH FOR ALLIANZGI - FONDS A200 CARDARELLI ANGELO		50.000
314	ALLIANZ GLOBAL INVESTORS EUROPEGMBH CARDARELLI ANGELO		1.047
319	ALLIANZ GLOBAL INVESTORS EUROPEGMBH CARDARELLI ANGELO		3.235
327	ALLIANZ GLOBAL INVESTORS EUROPEGMBH CARDARELLI ANGELO		392.196
332	ALLIANZ GLOBAL INVESTORS EUROPEGMBH CARDARELLI ANGELO		165.230
344	ALLIANZ GLOBAL INVESTORS EUROPEGMBH CARDARELLI ANGELO		61.810
345	ALLIANZ GLOBAL INVESTORS EUROPEGMBH CARDARELLI ANGELO		13.964
1361	ALLIANZ GLOBAL INVESTORS FUND CARDARELLI ANGELO		46.201
1365	ALLIANZ GLOBAL INVESTORS FUND CARDARELLI ANGELO		59.900
2507	ALLIANZ GLOBAL INVESTORS GMBH CARDARELLI ANGELO		42.300
3299	ALLIANZ GLOBAL INVESTORS GMBH CARDARELLI ANGELO		67.000
329	ALLIANZ GLOBAL INVESTORS GMBH ALLIANZ ALD FONDS CARDARELLI ANGELO		27.409
1263	ALLIANZ GLOBAL INVESTORS GMBH FOR ALLIANZGI-FONDS HPT CARDARELLI ANGELO		56.778

M. M.

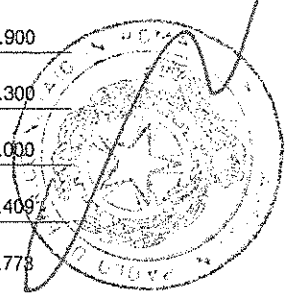

ASSEMBLEA ORDINARIA

81607/1032 12 MAGGIO 2016

Segreteria Societaria - Ufficio Titoli

**eni**

Unica convocazione

Esito della votazione sul punto 2

Attribuzione dell'utile di esercizio

Elenco Favorevoli

SCHEDA	VPC	NOMINATIVO AZIONISTA	DELEGATO	NUMERO DI AZIONI TOTALE
935		ALLIANZ GLOBAL INVESTORS GMBH FOR DBI-FONDS ANDUS	CARDARELLI ANGELO	70.316
1023		ALLIANZ GLOBAL INVESTORS GMBH FOR ELK-COFONDS	CARDARELLI ANGELO	20.021
1363		ALLIANZ STIFTUNGSFONDS NACHHALTIGKEIT	CARDARELLI ANGELO	21.152
1362		ALLIANZ SUISSE - STRATEGY FUND	CARDARELLI ANGELO	12.685
20		ALLIANZ SUISSE LEBENSVERSICHERUNGS-GESELLSCHAFT AG	CARDARELLI ANGELO	458.369
2555		ALLIANZGI PSDN	CARDARELLI ANGELO	23.000
2578		ALLIANZGI FOND AMMERLAND	CARDARELLI ANGELO	6.559
2546		ALLIANZGI FONDS ACK	CARDARELLI ANGELO	4.627
2552		ALLIANZGI FONDS AEVN	CARDARELLI ANGELO	77.630
2553		ALLIANZGI FONDS AEVN	CARDARELLI ANGELO	20.000
2554		ALLIANZGI FONDS AEVN	CARDARELLI ANGELO	216.147
2545		ALLIANZGI FONDS AFE	CARDARELLI ANGELO	6.186
2562		ALLIANZGI FONDS AFE	CARDARELLI ANGELO	40.040
2575		ALLIANZGI FONDS AFE	CARDARELLI ANGELO	80.469
2539		ALLIANZGI FONDS AKTIEN EUROPA	CARDARELLI ANGELO	79.000
2586		ALLIANZGI FONDS ALCO	CARDARELLI ANGELO	5.000
2533		ALLIANZGI FONDS ALLRA	CARDARELLI ANGELO	5.299
2532		ALLIANZGI FONDS ALPEN	CARDARELLI ANGELO	3.473
2535		ALLIANZGI FONDS APNIESA	CARDARELLI ANGELO	36.931
2536		ALLIANZGI FONDS APNIESA	CARDARELLI ANGELO	116.286
2531		ALLIANZGI FONDS AVP	CARDARELLI ANGELO	262
2530		ALLIANZGI FONDS BSP	CARDARELLI ANGELO	2.809
2591		ALLIANZGI FONDS BVK 1	CARDARELLI ANGELO	45.000

ASSEMBLEA ORDINARIA 12 MAGGIO 2016

Segreteria Societaria - Ufficio Titoli



eni

Unica convocazione

Esito della votazione sul punto 2

Attribuzione dell'utile di esercizio

81607/1033

Elenco Favorevoli

SCHEDA	VPC	NOMINATIVO AZIONISTA	DELEGATO	NUMERO DI AZIONI TOTALE
2529		ALLIANZGI FONDS CCS	CARDARELLI ANGELO	7.074
2584		ALLIANZGI FONDS COEN2	CARDARELLI ANGELO	25.000
2548		ALLIANZGI FONDS DBS	CARDARELLI ANGELO	1.492
2528		ALLIANZGI FONDS DIN	CARDARELLI ANGELO	10.000
2537		ALLIANZGI FONDS FEV	CARDARELLI ANGELO	4.076
2527		ALLIANZGI FONDS FIB	CARDARELLI ANGELO	15.600
2526		ALLIANZGI FONDS GANO	CARDARELLI ANGELO	1.494
2525		ALLIANZGI FONDS GANO 2	CARDARELLI ANGELO	3.492
2579		ALLIANZGI FONDS GDP	CARDARELLI ANGELO	16.000
2580		ALLIANZGI FONDS GEW	CARDARELLI ANGELO	2.236
2523		ALLIANZGI FONDS HAMONUS	CARDARELLI ANGELO	1.900
2576		ALLIANZGI FONDS HEUST	CARDARELLI ANGELO	8.240
2522		ALLIANZGI FONDS INDU	CARDARELLI ANGELO	7.135
2521		ALLIANZGI FONDS KDCO	CARDARELLI ANGELO	35.000
3027		ALLIANZGI FONDS LANXESS PENSION TRUST1	CARDARELLI ANGELO	16.800
2577		ALLIANZGI FONDS MASTER DRT	CARDARELLI ANGELO	21.500
2544		ALLIANZGI FONDS NASPA PENSIONSFONDS	CARDARELLI ANGELO	17.858
2520		ALLIANZGI FONDS OJU	CARDARELLI ANGELO	1.042
2549		ALLIANZGI FONDS PAK	CARDARELLI ANGELO	1.563
2551		ALLIANZGI FONDS PENSIONS	CARDARELLI ANGELO	17.176
2570		ALLIANZGI FONDS PF1	CARDARELLI ANGELO	13.784
2571		ALLIANZGI FONDS PF1	CARDARELLI ANGELO	11.08
2572		ALLIANZGI FONDS PF1	CARDARELLI ANGELO	18.799

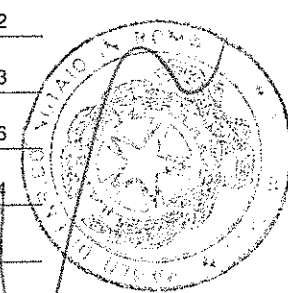

ASSEMBLEA ORDINARIA

81607/1034

12 MAGGIO 2016

Segreteria Societaria - Ufficio Titoli

**eni**

Unica convocazione

Esito della votazione sul punto 2

Attribuzione dell'utile di esercizio**Elenco Favorevoli**

SCHEDA	VPC	NOMINATIVO AZIONISTA	DELEGATO	NUMERO DI AZIONI TOTALE
2573		ALLIANZGI FONDS PF1	CARDARELLI ANGELO	19.662
2574		ALLIANZGI FONDS PF1	CARDARELLI ANGELO	22.195
2564		ALLIANZGI FONDS PF2	CARDARELLI ANGELO	10.493
2565		ALLIANZGI FONDS PF2	CARDARELLI ANGELO	37.711
2566		ALLIANZGI FONDS PF2	CARDARELLI ANGELO	17.420
2519		ALLIANZGI FONDS PFD	CARDARELLI ANGELO	1.233
2590		ALLIANZGI FONDS PGD	CARDARELLI ANGELO	15.651
2567		ALLIANZGI FONDS PTV2	CARDARELLI ANGELO	30.322
2568		ALLIANZGI FONDS PTV2	CARDARELLI ANGELO	25.091
2569		ALLIANZGI FONDS PTV2	CARDARELLI ANGELO	27.277
2518		ALLIANZGI FONDS REINVEST	CARDARELLI ANGELO	1.530
2517		ALLIANZGI FONDS SCHLUCCO	CARDARELLI ANGELO	11.000
2582		ALLIANZGI FONDS SIV	CARDARELLI ANGELO	20.000
2550		ALLIANZGI FONDS STIFTUNGSFONDS WISSENSCH	CARDARELLI ANGELO	4.516
2581		ALLIANZGI FONDS SWKA 1	CARDARELLI ANGELO	7.000
2585		ALLIANZGI FONDS TIBUR	CARDARELLI ANGELO	7.090
2557		ALLIANZGI FONDS TOSCA	CARDARELLI ANGELO	7.256
2516		ALLIANZGI FONDS UGF	CARDARELLI ANGELO	12.500
2592		ALLIANZGI FONDS USES	CARDARELLI ANGELO	30.447
2515		ALLIANZGI FONDS VBDK	CARDARELLI ANGELO	7.087
2514		ALLIANZGI FONDS VEMK	CARDARELLI ANGELO	1.409
2589		ALLIANZGI FONDS VSBW	CARDARELLI ANGELO	11.221
2534		ALLIANZGI FONDS VSF	CARDARELLI ANGELO	958

ASSEMBLEA ORDINARIA 12 MAGGIO 2016

Segreteria Societaria - Ufficio Titoli



eni

Unica convocazione

Esito della votazione sul punto 2

Attribuzione dell'utile di esercizio

81607/1035

Handwritten signature

Elenco Favorevoli

SCHEDA	VPC	NOMINATIVO AZIONISTA	DELEGATO	NUMERO DI AZIONI TOTALE
2513		ALLIANZGI FONDS WERT	CARDARELLI ANGELO	5.100
2512		ALLIANZGI FONDS ZUBB	CARDARELLI ANGELO	3.797
1028		ALLIANZGI GLOBAL FUNDAMENTAL STRATEGY FUND	CARDARELLI ANGELO	7.700
2556		ALLIANZGI SHL	CARDARELLI ANGELO	4.970
3028		ALLIANZGI-FONDS DSPT	CARDARELLI ANGELO	67.078
359		ALLSTATE LIFE INS COMPANY OF NY	CARDARELLI ANGELO	22.177
223		ALLSTATE LIFE INSURANCE EUROPEAN EQUITY PF	CARDARELLI ANGELO	47.371
281		ALLSTATE LIFE INSURANCE EUROPEAN EQUITY PF	CARDARELLI ANGELO	205.772
971		ALPS INTERNATIONAL SECTOR DIVIDEND DOGS ETF	CARDARELLI ANGELO	171.597
1750		AMERGEN CLINTON NUCLEAR POWER PLANT NONQUALIFIED FUND	CARDARELLI ANGELO	7.550
343		AMERICAFIRST DEFENSIVE GROWTH FUND	CARDARELLI ANGELO	106.247
1497		AMERICAN AIRLINES INC., MASTER FIXED BENEFIT PENSION TRUST	CARDARELLI ANGELO	266.753
1016		AMERICAN BEACON ADVISORS COLLECTIVE INVESTMENT TRUST	CARDARELLI ANGELO	142.513
1017		AMERICAN BEACON INTERNATIONAL EQUITY FUND	CARDARELLI ANGELO	606.519
958		AMERICAN CENTURY QUANTITATIVE EQUITY FUNDS, INC. INT CORE EQ	CARDARELLI ANGELO	9.542
961		AMERICAN CENTURY RETIREMENT DATE TRUST	CARDARELLI ANGELO	53.488
956		AMERICAN CENTURY STRAT ASSET ALL, INC. STRAT ALL MODERATE F	CARDARELLI ANGELO	66.227
957		AMERICAN CENTURY STRAT ASSET ALL, INC. STRATEGIC ALL AGGR F	CARDARELLI ANGELO	50.290
955		AMERICAN CENTURY STRATEGIC ASSET ALL, INC. STRAT ALL CONS F	CARDARELLI ANGELO	16.623
960		AMERICAN CENTURY WORLD MUTUAL FUNDS INC - NT INT VALUE FUND	CARDARELLI ANGELO	700.772
959		AMERICAN CENTURY WORLD MUTUAL FUNDS, INC. INTL VALUE F	CARDARELLI ANGELO	62.335
467		AMERICAN ELECTRIC POWER MASTER RETIREMENT TRUST	CARDARELLI ANGELO	151.479
468		AMERICAN ELECTRIC POWER MASTER RETIREMENT TRUST	CARDARELLI ANGELO	40.021

Handwritten signature

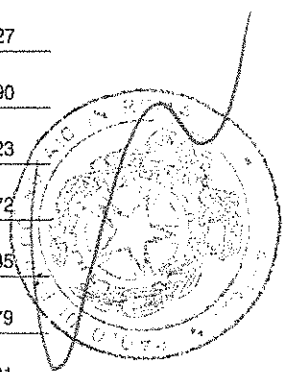

ASSEMBLEA ORDINARIA

81607/1036 12 MAGGIO 2016

Segreteria Societaria - Ufficio Titoli

**eni**

Unica convocazione

Esito della votazione sul punto 2

Attribuzione dell'utile di esercizio**Elenco Favorevoli**

SCHEDA	VPC	NOMINATIVO AZIONISTA	DELEGATO	NUMERO DI AZIONI TOTALE
515		AMERICAN ELECTRIC POWER SYSTEM RETIREE LIFE INSURANCE TRUST	CARDARELLI ANGELO	18.160
516		AMERICAN ELECTRIC POWER SYSTEM RETIREE MEDICAL TRUST FOR CERTAIN UNION	CARDARELLI ANGELO	35.528
501		AMERICAN FUNDS GLOBAL BALANCED FUND	CARDARELLI ANGELO	3.214.000
1061		AMERICAN FUNDS INSURANCE SERIES CAPITAL INCOME BUILDER	CARDARELLI ANGELO	26.766
1058		AMERICAN FUNDS INSURANCE SERIES GROWTH INCOME FUND	CARDARELLI ANGELO	1.775.727
1060		AMERICAN FUNDS INSURANCE SERIES INT GROWTH AND INCOME FUND	CARDARELLI ANGELO	250.000
1059		AMERICAN FUNDS INSURANCE SERIES INTERNATIONAL FUND	CARDARELLI ANGELO	426.000
394		AMERICAN HEART ASSOCIATION, INC	CARDARELLI ANGELO	12.547
395		AMERICAN HEART ASSOCIATION, INC	CARDARELLI ANGELO	4.054
1893		AMERICAN MEDICAL ASSOCIATION	CARDARELLI ANGELO	58.811
1894		AMERICAN MEDICAL ASSOCIATION	CARDARELLI ANGELO	20.379
3124		AMERIPRISE TRUST COMPANY	CARDARELLI ANGELO	1.889
3270		AMEV Leven Beleggingen	CARDARELLI ANGELO	68.553
3273		AMEV Schade Beleggingen	CARDARELLI ANGELO	20.636
2625		AMP INT EQ IND FD HEDGED	CARDARELLI ANGELO	45.495
2628		AMP INTERNATIONAL EQUITY INDEX FUND	CARDARELLI ANGELO	289.596
160		AMUNDI ACTIONS INTLES SMART BE	CARDARELLI ANGELO	14
816		AMUNDI APOLLINE ACTIONS EUROPE	CARDARELLI ANGELO	139.839
127		AMUNDI ETF SP EUROPE 350	CARDARELLI ANGELO	12.663
213		AMUNDI FUNDS INDEX EQUITY EURO	CARDARELLI ANGELO	11
219		AMUNDI FUNDS INDEX EQUITY JAPAN	CARDARELLI ANGELO	582.308
218		AMUNDI FUNDS INDEX EQUITY WORLD	CARDARELLI ANGELO	18
214		AMUNDI FUNDS INDEX EUROPE ACCOUNT	CARDARELLI ANGELO	31.529

ASSEMBLEA ORDINARIA 12 MAGGIO 2016

Segreteria Societaria - Ufficio Titoli



eni

81607/1037

M
M
M

Unica convocazione

Esito della votazione sul punto 2

Attribuzione dell'utile di esercizio

Elenco Favorevoli

SCHEDA	VPC	NOMINATIVO AZIONISTA	DELEGATO	NUMERO DI AZIONI TOTALE
215		AMUNDI FUNDS SELECT EURO	CARDARELLI ANGELO	18
216		AMUNDI FUNDS SELECT EURO	CARDARELLI ANGELO	147
121		AMUNDI SIF EUROPEAN EQUITY INDEX FUND	CARDARELLI ANGELO	840
217		AMUNDI SIF EUROPEAN EQUITY INDEX FUND	CARDARELLI ANGELO	7.342
1090		ANCHOR SERIES TRUST NATURAL RESOURCES PORTFOLIO	CARDARELLI ANGELO	270.201
3211		ANIMA SGR SPA - ANIMA EUROPA	CARDARELLI ANGELO	498.533
3215		ANIMA SGR SPA - FONDO ANIMA GEO EUROPA	CARDARELLI ANGELO	979.851
3216		ANIMA SGR SPA - FONDO ANIMA GEO ITALIA	CARDARELLI ANGELO	2.214.998
3212		ANIMA SGR SPA - FONDO ANIMA ITALIA	CARDARELLI ANGELO	1.295.288
3214		ANIMA SGR SPA - FONDO ANIMA SFORZESCO	CARDARELLI ANGELO	454.360
3213		ANIMA SGR SPA - FONDO ANIMA VISCONTEO	CARDARELLI ANGELO	791.280
1772		ANNE RAY CHARITABLE TRUST	CARDARELLI ANGELO	56.668
842		AON HEWITT COLLECTIVE INVESTMENT TRUST	CARDARELLI ANGELO	6.037
655		AON HEWITT GROUP TRUST	CARDARELLI ANGELO	14.714
656		AON HEWITT GROUP TRUST	CARDARELLI ANGELO	552.072
2641		APA SOLIDARITE FCP	CARDARELLI ANGELO	3.515
977		AQR COLLECTIVE INVESTMENT TRUST	CARDARELLI ANGELO	47.745
1189		AQR COLLECTIVE INVESTMENT TRUST	CARDARELLI ANGELO	7.470
979		AQR CUSTOMIZED REAL RETURN OFFSHORE FUND, L.P.	CARDARELLI ANGELO	31.991
1653		AQR FUNDS - AQR EQUITY MARKET NEUTRAL FUND	CARDARELLI ANGELO	95.536
2937		AQR FUNDS - AQR INTERNATIONAL DEFENSIVE EQUITY FUND CORPORATION SERVICE COMPANY	CARDARELLI ANGELO	3.488
2956		AQR FUNDS - AQR INTERNATIONAL MULTI-STYLE FUND CORPORATION SERVICE COMPANY	CARDARELLI ANGELO	45.955
3059		AQR FUNDS - AQR INTERNATIONAL MULTI-STYLE FUND CORPORATION SERVICE COMPANY	CARDARELLI ANGELO	5.508

M
M
M

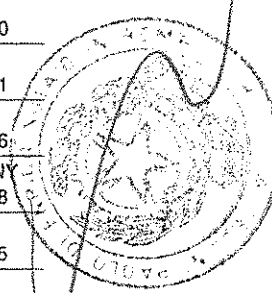

ASSEMBLEA ORDINARIA

81607/1038 12 MAGGIO 2016

Segreteria Societaria - Ufficio Titoli



eni

Unica convocazione

Esito della votazione sul punto 2

Attribuzione dell'utile di esercizio

Elenco Favorevoli

SCHEDA	VPC	NOMINATIVO AZIONISTA	DELEGATO	NUMERO DI AZIONI TOTALE
1656		AQR FUNDS - AQR LONG SHORT EQUITY FUND	CARDARELLI ANGELO	125.562
2942		AQR FUNDS AQR TAX-MANAGED INTL MOMENTUM	CARDARELLI ANGELO	36.371
1654		AQR FUNDS- AQR STYLE PREMIA ALTERNATIVE LV FUND	CARDARELLI ANGELO	2.726
1733		AQR GLOBAL ENHANCED EQUITY FUND	CARDARELLI ANGELO	66.199
2943		AQR GLOBAL EQUITY FUND	CARDARELLI ANGELO	22.885
1660		AQR GLOBAL LONG-SHORT QUITY FUND	CARDARELLI ANGELO	45.946
2955		AQR INTERNATIONAL EQUITY FUND	CARDARELLI ANGELO	38.064
978		AQR INTERNATIONAL EQUITY INTEGRATED ALPHA FUND, L.P.	CARDARELLI ANGELO	3.613
3058		AQR INTERNATIONAL MOMENTUM FUND	CARDARELLI ANGELO	74.076
976		AQR MULTI-STYLE OFFSHORE FUND, L.P.	CARDARELLI ANGELO	36.379
980		AQR REAL ASSET FUND II, L.P.	CARDARELLI ANGELO	6.706
981		AQR REAL RETURN MASTER ACCOUNT, L.P.	CARDARELLI ANGELO	41.491
1657		AQR Tax Plus U.S. Relaxed Constraint Equity Fund	CARDARELLI ANGELO	755
2778		AQR UCITS FUNDS	CARDARELLI ANGELO	401
1663		ARAB BANK FOR ECONOMIC DEVELOPMENT IN AFRICA	CARDARELLI ANGELO	11.470
2967		ARAB FUND FOR ECONOMIC AND SOCIAL DEVELO	CARDARELLI ANGELO	6.443
2471		ARABELLE INVESTISSEMENTS	CARDARELLI ANGELO	3.000
557		ARCHDIOCESE OF HARTFORD INVESTMENT TRUST	CARDARELLI ANGELO	2.447
795		AREGE 2IC	CARDARELLI ANGELO	17.132
645		ARIZONA PSPRS TRUST	CARDARELLI ANGELO	121.722
953		ARIZONA STATE RETIREMENT SYSTEM	CARDARELLI ANGELO	206.439
954		ARIZONA STATE RETIREMENT SYSTEM	CARDARELLI ANGELO	1.074.711
2787		ARK LIFE ASSURANCE COMPANY LIMITED	CARDARELLI ANGELO	16.073

ASSEMBLEA ORDINARIA 12 MAGGIO 2016

Segreteria Societaria - Ufficio Titoli

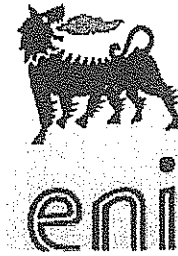

81607/1039

M...

Unica convocazione

Esito della votazione sul punto 2

Attribuzione dell'utile di esercizio

Elenco Favorevoli

SCHEDA	VPC	NOMINATIVO AZIONISTA	DELEGATO	NUMERO DI AZIONI TOTALE
3289		ARK LIFE ASSURANCE COMPANY LIMITED	CARDARELLI ANGELO	22.193
3290		ARK LIFE ASSURANCE COMPANY LIMITED	CARDARELLI ANGELO	81.806
3291		ARK LIFE ASSURANCE COMPANY LIMITED	CARDARELLI ANGELO	38.993
3292		ARK LIFE ASSURANCE COMPANY LIMITED	CARDARELLI ANGELO	7.400
875		ARKWRIGHT, LLC	CARDARELLI ANGELO	8.297
2922		ARMSTRONG WORLD INDUSTRIES INC MASTER TR	CARDARELLI ANGELO	48.841
2944		ARMSTRONG WORLD INDUSTRIES INC MASTER TR	CARDARELLI ANGELO	41.197
2249		ARRCO LONG TERME	CARDARELLI ANGELO	70.517
776		ARRCO LONG TERME D ACTIONS	CARDARELLI ANGELO	209.890
2252		ARRCO QUANT 1	CARDARELLI ANGELO	211.619
654		ARROWSTREET COLLECTIVE INVESTMENT TRUST	CARDARELLI ANGELO	84.731
843		ARROWSTREET US GROUP TRUST	CARDARELLI ANGELO	26.665
1839		ASCENSION ALPHA FUND, LLC	CARDARELLI ANGELO	562.869
1521		ASCENSION HEALTH MASTER PENSION TRUST	CARDARELLI ANGELO	314.935
1140		ASHWOOD INVESTMENTS LIMITED	CARDARELLI ANGELO	8.891
1266		ASIAN DEVELOPMENT BANK	CARDARELLI ANGELO	121.217
3267		ASR Euro Aandelen Pool	CARDARELLI ANGELO	261.923
3269		ASR Euro Aandelen Pool (Assets)	CARDARELLI ANGELO	86.473
3266		ASR Europese Aandelen Pool	CARDARELLI ANGELO	52.425
3271		ASR LEVENSVERZEKERING N.V.	CARDARELLI ANGELO	145.145
349		ASSOCIATED BRITISH FOODS PENSION SCHEME	CARDARELLI ANGELO	8.480
3154		ASSOCIATION DE BIENFAISANCE ET DE RETRAITE DES POLICIERS ET POLICIERES DE LA VILLE DE	CARDARELLI ANGELO	47.263
139		ASSURDIX	CARDARELLI ANGELO	18

S...

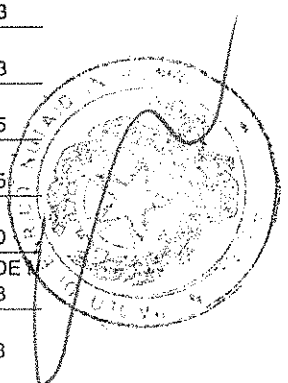

ASSEMBLEA ORDINARIA

81607/2016 12 MAGGIO 2016

Segreteria Societaria - Ufficio Titoli



eni

Unica convocazione

Esito della votazione sul punto 2

Attribuzione dell'utile di esercizio

Elenco Favorevoli

SCHEDA	VPC	NOMINATIVO AZIONISTA	DELEGATO	NUMERO DI AZIONI TOTALE
677		AT&T SAVINGS GROUP INVESTMEN TRUST	CARDARELLI ANGELO	11.242
658		AT&T UNION WELFARE BENEFIT TRUST	CARDARELLI ANGELO	57.053
82		ATLAS ENHANCED MASTER FUND	CARDARELLI ANGELO	1.134.400
80		ATLAS MASTER FUND LTD	CARDARELLI ANGELO	79.052
83		ATLAS MASTER FUND LTD.	CARDARELLI ANGELO	418.627
165		ATOUT EUROLAND	CARDARELLI ANGELO	399.818
162		ATOUT EUROLAND HAUT RENDEMENT	CARDARELLI ANGELO	11
163		ATOUT EUROLAND MIN VAR	CARDARELLI ANGELO	19
164		ATOUT EUROLAND RESTRUCTURATION	CARDARELLI ANGELO	14
156		ATOUT EUROPE RESTRUCTURATION	CARDARELLI ANGELO	12
157		ATOUT EUROPE SELECT	CARDARELLI ANGELO	15
158		ATOUT EUROPE SMART BETA	CARDARELLI ANGELO	14
142		ATOUT MODERATIONS	CARDARELLI ANGELO	14
133		ATOUT VALEURS DURABLES	CARDARELLI ANGELO	7.971
2017		AUSTRALIA POST SUPERANNUATION SCHEME	CARDARELLI ANGELO	8.597
2629		AUSTRALIAN CATHOLIC SUPERAN RETIREM FUND	CARDARELLI ANGELO	15.669
2478		AVENIR EURO	CARDARELLI ANGELO	180.000
3244		AVIVA INVEST MANAGER ICVC EURO EQUITY MO	CARDARELLI ANGELO	118.976
25		AVIVA INVESTORS INTERNATIONAL INDEX TRACKING FUND	CARDARELLI ANGELO	45.924
3235		AVIVA LIFE & PENSIONS UK LIMITED	CARDARELLI ANGELO	143.188
3236		AVIVA LIFE & PENSIONS UK LIMITED	CARDARELLI ANGELO	129.498
3237		AVIVA LIFE & PENSIONS UK LIMITED	CARDARELLI ANGELO	92.347
3240		AVIVA LIFE AND PENSIONS UK LIMITED	CARDARELLI ANGELO	106.592

ASSEMBLEA ORDINARIA 12 MAGGIO 2016

Segreteria Societaria - Ufficio Titoli



eni

81607/1061

Manfredi

Unica convocazione

Esito della votazione sul punto 2

Attribuzione dell'utile di esercizio

Elenco Favorevoli

SCHEDA	VPC	NOMINATIVO AZIONISTA	DELEGATO	NUMERO DI AZIONI TOTALE
3241		AVIVA LIFE AND PENSIONS UK LIMITED	CARDARELLI ANGELO	73.298
2886		AXA EQUITABLE LIFE INSURANCE CO	CARDARELLI ANGELO	3.830
2909		AXA EQUITABLE LIFE INSURANCE CO	CARDARELLI ANGELO	35.622
2487		AXA GENERATION EQUILIBRE 2 FCPE	CARDARELLI ANGELO	278.500
3045		AXA IRELAND PENSION FUND	CARDARELLI ANGELO	45.000
983		AXA ROSENBERG EQUITY ALPHA TRUST	CARDARELLI ANGELO	5.000
2492		AXA VALEURS EURO	CARDARELLI ANGELO	200.000
1354		AXA WORLD FUNDS	CARDARELLI ANGELO	2.500.000
1355		AXA WORLD FUNDS	CARDARELLI ANGELO	15.381
1356		AXA WORLD FUNDS	CARDARELLI ANGELO	48.095
1357		AXA WORLD FUNDS	CARDARELLI ANGELO	930.000
1358		AXA WORLD FUNDS	CARDARELLI ANGELO	1.000.000
1359		AXA WORLD FUNDS	CARDARELLI ANGELO	304.673
1360		AXA WORLD FUNDS	CARDARELLI ANGELO	650.463
3029		AXA-EB 510	CARDARELLI ANGELO	7.200
490		AZL FRANKLIN TEMPLETON FOUNDINGSTRATEGY PLUS FUND	CARDARELLI ANGELO	112.900
491		AZL INTERNATIONAL INDEX FUND	CARDARELLI ANGELO	122.667
3272		Amersf Alg Beleggingen inzake AOV	CARDARELLI ANGELO	29.879
2511		BAD COFONDS	CARDARELLI ANGELO	19.952
2510		BAD COFONDS II	CARDARELLI ANGELO	3.703
1751		BAE SYSTEMS PENSION FUNDS COMMON INVESTMENT FUND	CARDARELLI ANGELO	259.464
227		BANCO BILBAO VIZCAYA ARGENTARIASA	CARDARELLI ANGELO	65.949
233		BANCO BILBAO VIZCAYA ARGENTARIASA	CARDARELLI ANGELO	495.853

Manfredi

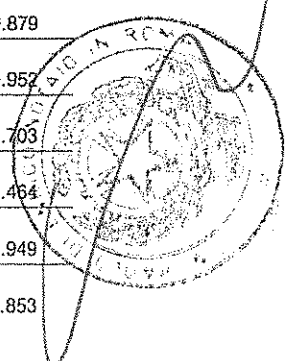

ASSEMBLEA ORDINARIA

81607/1002 12 MAGGIO 2016

Segreteria Societaria - Ufficio Titoli



eni

Unica convocazione

Esito della votazione sul punto 2

Attribuzione dell'utile di esercizio

Elenco Favorevoli

SCHEDA	VPC	NOMINATIVO AZIONISTA	DELEGATO	NUMERO DI AZIONI TOTALE
2864		BANCO CENTRAL DE TIMOR EST	CARDARELLI ANGELO	219.738
2865		BANCO CENTRAL DE TIMOR EST	CARDARELLI ANGELO	222.368
229		BANCO NACIONAL DE PANAMA AS TRUSTEE OF FIDEICOMISO FONDO DE AHORRO DE PANAMA	CARDARELLI ANGELO	12.062
1801		BANK NEGARA MALAYSIA	CARDARELLI ANGELO	228.105
1863		BANK OF BOTSWANA	CARDARELLI ANGELO	68.192
1864		BANK OF BOTSWANA	CARDARELLI ANGELO	20.072
1205		BANK OF KOREA	CARDARELLI ANGELO	142.864
1206		BANK OF KOREA	CARDARELLI ANGELO	47.229
1212		BANK OF KOREA	CARDARELLI ANGELO	76.784
1949		BANNER HEALTH	CARDARELLI ANGELO	199.611
2724		BANQUE PICTET & CIE SA	CARDARELLI ANGELO	117.209
2725		BANQUE PICTET & CIE SA	CARDARELLI ANGELO	33.970
2727		BANQUE PICTET & CIE SA	CARDARELLI ANGELO	24.871
2729		BANQUE PICTET & CIE SA	CARDARELLI ANGELO	51.052
493		BAPTIST FOUNDATION OF TEXAS	CARDARELLI ANGELO	143.427
494		BAPTIST FOUNDATION OF TEXAS	CARDARELLI ANGELO	47.799
3113		BAPTIST HEALTH SOUTH FLORIDA INC	CARDARELLI ANGELO	248.427
2059		BARING COMPONENT FUNDS	CARDARELLI ANGELO	303.904
714		BARROW HANLEY MEWHINNEY & STRA	CARDARELLI ANGELO	7.810
2347		BAYERNINVEST KAPITALVERWALTUNGSGESELLSCHAFT MBH	CARDARELLI ANGELO	113.861
2345		BAYERNINVEST KVG MBH	CARDARELLI ANGELO	1.238.075
3294		BAYERNINVEST KVG MBH	CARDARELLI ANGELO	46.785
3295		BAYERNINVEST KVG MBH	CARDARELLI ANGELO	6.080

ASSEMBLEA ORDINARIA 12 MAGGIO 2016

Segreteria Societaria - Ufficio Titoli



eni

81607/1003

L
C

Unica convocazione

Esito della votazione sul punto 2

Attribuzione dell'utile di esercizio

Elenco Favorevoli

SCHEDA	VPC	NOMINATIVO AZIONISTA	DELEGATO	NUMERO DI AZIONI TOTALE
2595	BAYVK A4 FONDS		CARDARELLI ANGELO	22.883
2596	BAYVK G1 BVK INDEX		CARDARELLI ANGELO	159.633
2594	BAYVK G2 FONDS		CARDARELLI ANGELO	238.611
3202	BBH & CO BOSTON CUSTODIAN FOR FIDELITY GROUP TRUST FOR THE EMPLOYEE BENEFIT PLANS -		CARDARELLI ANGELO	72.500
3204	BBH CO BOSTON CUSTODIAN FOR GALLERY TRUST - MONDRIAN INTERNATIONAL EQUITY FUND		CARDARELLI ANGELO	527.260
3201	BBH CONTRAFUND FIDELITY ADVISOR SERIES OPPORTUNISTIC INSIGHTS FUND		CARDARELLI ANGELO	5.600
3205	BBH FOR FIDELITY SERIES OPPORTUNISTIC INSIGHTS FUND		CARDARELLI ANGELO	38.800
2357	BBH INTERNATIONAL EQUITY FUND		CARDARELLI ANGELO	656.061
2385	BBH INTERNATIONAL EQUITY MASTER		CARDARELLI ANGELO	86.515
2241	BBH TRUSTEE SERVICES		CARDARELLI ANGELO	4.980
1802	BEAT DRUGS FUND ASSOCIATION		CARDARELLI ANGELO	3.544
2858	BELEGGINGSFONDS BELCENA		CARDARELLI ANGELO	62.082
627	BELL ATLANTIC MASTER TRUST		CARDARELLI ANGELO	198.668
628	BELL ATLANTIC MASTER TRUST		CARDARELLI ANGELO	23.553
629	BELL ATLANTIC MASTER TRUST		CARDARELLI ANGELO	26.504
630	BELL ATLANTIC MASTER TRUST		CARDARELLI ANGELO	127.549
631	BELL ATLANTIC MASTER TRUST		CARDARELLI ANGELO	40.838
496	BELLSOUTH CORPORATION RFA VEBA TRUST		CARDARELLI ANGELO	67.506
40	BERESFORD FUNDS PLC		CARDARELLI ANGELO	663.506
2823	BEROLINARENT DEKA		CARDARELLI ANGELO	5.100
2426	BEST INVESTMENT CORPORATION		CARDARELLI ANGELO	50.499
3172	BF AND M LIFE INSURANCE COMPANY LTD		CARDARELLI ANGELO	17.543
1462	BGI MSCI EAFE EQUITY INDEX NON-LENDABLE FUND B		CARDARELLI ANGELO	879.040

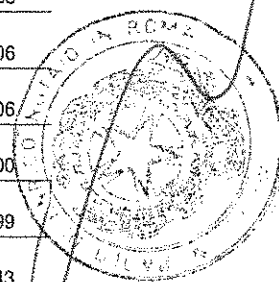

ASSEMBLEA ORDINARIA

81607/1014 12 MAGGIO 2016

Segreteria Societaria - Ufficio Titoli



eni

Unica convocazione

Esito della votazione sul punto 2

Attribuzione dell'utile di esercizio

Elenco Favorevoli

SCHEDA	VPC	NOMINATIVO AZIONISTA	DELEGATO	NUMERO DI AZIONI TOTALE
1463	BGI MSCI EMU IMI INDEX FUND B		CARDARELLI ANGELO	2.303
1461	BGI MSCI EUROPE EQUITY INDEX FUND B		CARDARELLI ANGELO	813.525
1208	BIMCOR GLOBAL EQUITY POOLED FUND		CARDARELLI ANGELO	92.482
1209	BIMCOR GLOBAL EQUITY POOLED FUND		CARDARELLI ANGELO	1.325
1207	BIMCOR OVERSEAS POOLED FUND		CARDARELLI ANGELO	88.706
2849	BIRELEY'S ORANGE JAPAN, S.A.		CARDARELLI ANGELO	1.908
1637	BLACKROCK AM DE AG FOR ISHARES EURO STOXX 50 UCITS ETF (DE)		CARDARELLI ANGELO	7.497.571
1639	BLACKROCK AM DE FOR ISHARES EURO STOXX UCITS ETF (DE)		CARDARELLI ANGELO	915.841
1640	BLACKROCK AM DE FOR ISHARES STOXX EUROPE 50 UCITS ETF (DE)		CARDARELLI ANGELO	269.374
1643	BLACKROCK AM DE FOR ISHARES STOXX EUROPE 600 UCITS ETF (DE)		CARDARELLI ANGELO	1.927.504
1638	BLACKROCK AM DE FOR ISHS DJ EUROZONE SUST SCR. UCITS ETF (DE)		CARDARELLI ANGELO	232.886
1641	BLACKROCK AM DE FOR ISHS STOXX EUROPE LARGE 200 UCITS ETF (DE)		CARDARELLI ANGELO	22.251
1649	BLACKROCK AM SCHWEIZ AG OBO BIFS WORLD EX SWITZ EQ INDEX FUND		CARDARELLI ANGELO	11.954
1444	BLACKROCK CDN MSCI EAFE EQUITY INDEX FUND		CARDARELLI ANGELO	743.904
1447	BLACKROCK CDN MSCI EAFE INDEX PLUS FUND		CARDARELLI ANGELO	20.688
1446	BLACKROCK CDN WORLD INDEX FUND		CARDARELLI ANGELO	102.760
425	BLACKROCK COMMODITIES INCOME INVESTMENT TRUST PLC		CARDARELLI ANGELO	195.450
2878	BLACKROCK FISSION INDEXED INTL EQUITY FD		CARDARELLI ANGELO	79.752
443	BLACKROCK FUNDS ALL-CAP ENERGY AND RESOURCES PORTFOLIO		CARDARELLI ANGELO	157.400
310	BLACKROCK FUNDS GLOBAL OPPORTUNITIES PORTFOLIO		CARDARELLI ANGELO	112.400
300	BLACKROCK FUNDS INTERNATIONAL OPPORTUNITIES PORTFOLIO		CARDARELLI ANGELO	716.800
441	BLACKROCK GLOBAL ENERGY AND RESOURCES TRUST		CARDARELLI ANGELO	533.450
246	BLACKROCK GLOBAL FUNDS		CARDARELLI ANGELO	126.920

ASSEMBLEA ORDINARIA 12 MAGGIO 2016

Segreteria Societaria - Ufficio Titoli



eni

81607/1045

L
M
M

Unica convocazione

Esito della votazione sul punto 2

Attribuzione dell'utile di esercizio

Elenco Favorevoli

SCHEDA	VPC	NOMINATIVO AZIONISTA	DELEGATO	NUMERO DI AZIONI TOTALE
247	BLACKROCK GLOBAL FUNDS		CARDARELLI ANGELO	13.954
460	BLACKROCK GLOBAL FUNDS		CARDARELLI ANGELO	11.342
461	BLACKROCK GLOBAL FUNDS		CARDARELLI ANGELO	2.498.050
1372	BLACKROCK GLOBAL INDEX FUNDS		CARDARELLI ANGELO	51.579
1373	BLACKROCK GLOBAL INDEX FUNDS		CARDARELLI ANGELO	137.710
252	BLACKROCK GLOBAL OPPORTUNITIES EQUITY TRUST		CARDARELLI ANGELO	445.200
220	BLACKROCK GLOBAL OPPORTUNITIES V.I. FUND OF BLACKROCK VARIABLESERIES FUNDS,INC		CARDARELLI ANGELO	18.795
2793	BLACKROCK INDEX SELECTION FUND		CARDARELLI ANGELO	980.534
2794	BLACKROCK INDEX SELECTION FUND		CARDARELLI ANGELO	829.018
2795	BLACKROCK INDEX SELECTION FUND		CARDARELLI ANGELO	46.889
2796	BLACKROCK INDEX SELECTION FUND		CARDARELLI ANGELO	124.417
2797	BLACKROCK INDEX SELECTION FUND		CARDARELLI ANGELO	15.588
2876	BLACKROCK INDEXED ALL-COUNTRY EQUITY FUN		CARDARELLI ANGELO	12.916
1419	BLACKROCK INST TRUST CO NA INV FUNDSFOR EMPLOYEE BENEFIT TR		CARDARELLI ANGELO	4.131.318
1420	BLACKROCK INST TRUST CO NA INV FUNDSFOR EMPLOYEE BENEFIT TR		CARDARELLI ANGELO	447.896
1421	BLACKROCK INST TRUST CO NA INV FUNDSFOR EMPLOYEE BENEFIT TR		CARDARELLI ANGELO	272.700
1422	BLACKROCK INST TRUST CO NA INV FUNDSFOR EMPLOYEE BENEFIT TR		CARDARELLI ANGELO	45.700
1434	BLACKROCK INST TRUST CO NA INV FUNDSFOR EMPLOYEE BENEFIT TR		CARDARELLI ANGELO	8.226.494
1435	BLACKROCK INST TRUST CO NA INV FUNDSFOR EMPLOYEE BENEFIT TR		CARDARELLI ANGELO	75.619
1436	BLACKROCK INST TRUST CO NA INV FUNDSFOR EMPLOYEE BENEFIT TR		CARDARELLI ANGELO	449.031
1437	BLACKROCK INST TRUST CO NA INV FUNDSFOR EMPLOYEE BENEFIT TR		CARDARELLI ANGELO	3.941
1438	BLACKROCK INST TRUST CO NA INV FUNDSFOR EMPLOYEE BENEFIT TR		CARDARELLI ANGELO	2.735.316
1439	BLACKROCK INST TRUST CO NA INV FUNDSFOR EMPLOYEE BENEFIT TR		CARDARELLI ANGELO	238.680

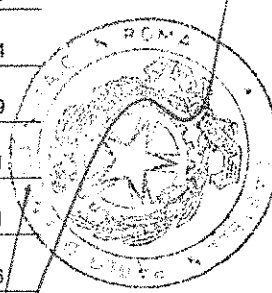

ASSEMBLEA ORDINARIA

81607/2016 12 MAGGIO 2016

Segreteria Societaria - Ufficio Titoli



eni

Unica convocazione

Esito della votazione sul punto 2

Attribuzione dell'utile di esercizio

Elenco Favorevoli

SCHEDA	VPC	NOMINATIVO AZIONISTA	DELEGATO	NUMERO DI AZIONI TOTALE
1442		BLACKROCK INST TRUST CO NA INV FUNDSFOR EMPLOYEE BENEFIT TR	CARDARELLI ANGELO	4.406
1443		BLACKROCK INST TRUST CO NA INV FUNDSFOR EMPLOYEE BENEFIT TR	CARDARELLI ANGELO	19.745
1448		BLACKROCK INST TRUST CO NA INV FUNDSFOR EMPLOYEE BENEFIT TR	CARDARELLI ANGELO	83.068
1449		BLACKROCK INST TRUST CO NA INV FUNDSFOR EMPLOYEE BENEFIT TR	CARDARELLI ANGELO	3.715.356
1450		BLACKROCK INST TRUST CO NA INV FUNDSFOR EMPLOYEE BENEFIT TR	CARDARELLI ANGELO	337.617
1451		BLACKROCK INST TRUST CO NA INV FUNDSFOR EMPLOYEE BENEFIT TR	CARDARELLI ANGELO	366.126
1452		BLACKROCK INST TRUST CO NA INV FUNDSFOR EMPLOYEE BENEFIT TR	CARDARELLI ANGELO	29.157
2786		BLACKROCK INSTITUTIONAL JERSEY FUNDS	CARDARELLI ANGELO	21.033
2798		BLACKROCK INSTITUTIONAL POOLED FUNDS PLC	CARDARELLI ANGELO	15.203
2799		BLACKROCK INSTITUTIONAL POOLED FUNDS PLC	CARDARELLI ANGELO	4.881
2873		BLACKROCK INTERNATIONAL ALPHA TILTS FUND	CARDARELLI ANGELO	81.298
255		BLACKROCK INTERNATIONAL GROWTH AND INCOME TRUST	CARDARELLI ANGELO	543.200
320		BLACKROCK LIFE LIMITED	CARDARELLI ANGELO	5.869.339
321		BLACKROCK LIFE LIMITED	CARDARELLI ANGELO	63.052
322		BLACKROCK LIFE LIMITED	CARDARELLI ANGELO	13.610
323		BLACKROCK LIFE LIMITED	CARDARELLI ANGELO	58.043
324		BLACKROCK LIFE LIMITED	CARDARELLI ANGELO	402.776
325		BLACKROCK LIFE LIMITED	CARDARELLI ANGELO	659.011
326		BLACKROCK LIFE LIMITED	CARDARELLI ANGELO	178.779
293		BLACKROCK MANAGED VOLATILITY V.I. FUND OF BLACKROCK VARIABLESERIES FUNDS INC	CARDARELLI ANGELO	27.567
1466		BLACKROCK MSCI EUROPE EQUITY ESG SCREENED INDEX FUND B	CARDARELLI ANGELO	80.270
1467		BLACKROCK MSCI WORLD EQUITY ESG SCREENED INDEX FUND B	CARDARELLI ANGELO	207.818
1418		BLACKROCK MSCI WORLD INDEX FUND OF BLACKROCK FUNDS	CARDARELLI ANGELO	19.323

ASSEMBLEA ORDINARIA 12 MAGGIO 2016

Segreteria Societaria - Ufficio Titoli



eni

81507/1067

Handwritten signature

Unica convocazione

Esito della votazione sul punto 2

Attribuzione dell'utile di esercizio

Elenco Favorevoli

SCHEDA	VPC	NOMINATIVO AZIONISTA	DELEGATO	NUMERO DI AZIONI TOTALE
2792		BLACKROCK SELECTION FUND	CARDARELLI ANGELO	230.420
1369		BLACKROCK STRATEGIC FUNDS	CARDARELLI ANGELO	17.699
1370		BLACKROCK STRATEGIC FUNDS	CARDARELLI ANGELO	4.152
1371		BLACKROCK STRATEGIC FUNDS	CARDARELLI ANGELO	14.619
2912		BLACKROCK WHOLESALE INDEXED INTERNATIONAL	CARDARELLI ANGELO	159.922
1895		BLUE SHIELD OF CALIFORNIA EMPLOYEES' RETIREMENT PLAN	CARDARELLI ANGELO	58.669
1885		BLUE SKY GROUP	CARDARELLI ANGELO	195.324
1886		BLUE SKY GROUP	CARDARELLI ANGELO	289.450
575		BMO MSCI EAFE HEDGED TO CAD INDEX E	CARDARELLI ANGELO	12.408
236		BNM T&D (UK) LIMITED AS TRUSTEE OF BR DYNAMIC DIV. GROWTH FUND	CARDARELLI ANGELO	11.203
2253		BNP PAM	CARDARELLI ANGELO	347.259
2612		BNP PARIBAS A FUND	CARDARELLI ANGELO	49.441
207		BNP PARIBAS APOLLINE ACTIONS EURO	CARDARELLI ANGELO	266.969
2606		BNP PARIBAS B INVEST	CARDARELLI ANGELO	10.909
2607		BNP PARIBAS B INVEST	CARDARELLI ANGELO	13.794
2604		BNP PARIBAS B PENSION BALANCED	CARDARELLI ANGELO	118.242
2617		BNP PARIBAS B PENSION BALANCED	CARDARELLI ANGELO	669.615
2605		BNP PARIBAS B PENSION STABILITY	CARDARELLI ANGELO	48.393
2433		BNP PARIBAS FLOREAL 30	CARDARELLI ANGELO	57.774
2432		BNP PARIBAS FLOREAL 70	CARDARELLI ANGELO	61.437
2608		BNP PARIBAS FUND I	CARDARELLI ANGELO	312.352
2609		BNP PARIBAS FUND III NV	CARDARELLI ANGELO	4.354
2616		BNP PARIBAS FUND III NV	CARDARELLI ANGELO	1.229

Handwritten signature

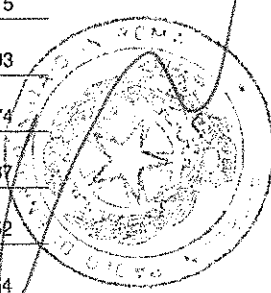

ASSEMBLEA ORDINARIA

81607/10618 12 MAGGIO 2016

Segreteria Societaria - Ufficio Titoli



eni

Unica convocazione

Esito della votazione sul punto 2

Attribuzione dell'utile di esercizio

Elenco Favorevoli

SCHEDA	VPC	NOMINATIVO AZIONISTA	DELEGATO	NUMERO DI AZIONI TOTALE
2461	BNP PARIBAS	INDICE EURO	CARDARELLI ANGELO	506.705
2600	BNP PARIBAS	L1	CARDARELLI ANGELO	24.880
2601	BNP PARIBAS	L1	CARDARELLI ANGELO	623.130
2602	BNP PARIBAS	L1	CARDARELLI ANGELO	937.878
2610	BNP PARIBAS	L1	CARDARELLI ANGELO	734.065
2611	BNP PARIBAS	L1	CARDARELLI ANGELO	55.431
2613	BNP PARIBAS	L1	CARDARELLI ANGELO	127.799
610	BNY MELLON CORP RETIREMENT PLANS MASTER TRUST		CARDARELLI ANGELO	81.695
543	BNY MELLON EMPLOYEE BENEFIT COLLECTIVE INVESTMENT FUND PLAN		CARDARELLI ANGELO	190.605
601	BNY MELLON EMPLOYEE BENEFIT COLLECTIVE INVESTMENT FUND PLAN		CARDARELLI ANGELO	235.704
602	BNY MELLON EMPLOYEE BENEFIT COLLECTIVE INVESTMENT FUND PLAN		CARDARELLI ANGELO	1.343.866
603	BNY MELLON EMPLOYEE BENEFIT COLLECTIVE INVESTMENT FUND PLAN		CARDARELLI ANGELO	231.184
373	BNY MELLON FUNDS TRUST BNY MELLON INTL EQUITY INCOME FUND		CARDARELLI ANGELO	36.105
1685	BNY MELLON T+D (UK) ATF ST. JAMES'S PLACE HIGH OCTANE UNIT TR		CARDARELLI ANGELO	851.337
1686	BNY MELLON TR+DEP ATF ST. JAMES'S PLACE GLOBAL EQ UNIT TR		CARDARELLI ANGELO	130.894
1717	BNY MELLON TR+DEP ATF ST. JAMES'S PLACE MNGD GROWTH UNIT TR		CARDARELLI ANGELO	812.022
365	BNY MELLON TRUST AND DEPOSITARY(UK) LTD AS TRUSTEE OF BLACKROCKSYSTEMATIC CONTINE		CARDARELLI ANGELO	4.682
235	BNYMTD (UK) AS TRUSTEE OF BLACKROCK CONTINENTAL EUROPE EQUITY TRY TRACKER FUND		CARDARELLI ANGELO	1.875.483
234	BNYMTD (UK) LTD AS TRUSTEE OF BLACKROCK GLOBAL EQUITY FUNDEQUITY FUND		CARDARELLI ANGELO	72.500
371	BOC PENSION INVESTMENT FUND		CARDARELLI ANGELO	27.995
3253	BOMBARDIER TRUST(CANADA) GLOBAL EQUIT FU		CARDARELLI ANGELO	18.485
2621	BPCB DPF ECCLESTON G		CARDARELLI ANGELO	51.569
435	BPL		CARDARELLI ANGELO	1.153.143

ASSEMBLEA ORDINARIA 12 MAGGIO 2016

Segreteria Societaria - Ufficio Titoli



eni

81607/1049

Handwritten signature

Unica convocazione

Esito della votazione sul punto 2

Attribuzione dell'utile di esercizio

Elenco Favorevoli

SCHEDA	VPC	NOMINATIVO AZIONISTA	DELEGATO	NUMERO DI AZIONI TOTALE
1149		BRANDES CANADA GLOBAL EQUITY UNIT TRUST	CARDARELLI ANGELO	39.700
1148		BRANDES CANADA INTERNATIONAL EQUITY UNIT TRUST	CARDARELLI ANGELO	516.432
1567		BRANDES GLOBAL BALANCED FUND	CARDARELLI ANGELO	28.955
893		BRANDES GLOBAL EQUITY FUND	CARDARELLI ANGELO	51.677
1569		BRANDES GLOBAL EQUITY FUND	CARDARELLI ANGELO	387.452
895		BRANDES GLOBAL EQUITY INCOME FUND	CARDARELLI ANGELO	1.184
1150		BRANDES GLOBAL OPPORTUNITIES FUND	CARDARELLI ANGELO	133.008
894		BRANDES GLOBAL OPPORTUNITIES VALUE FUND	CARDARELLI ANGELO	7.826
1820		BRANDES INSTITUTIONAL EQUITY TRUST	CARDARELLI ANGELO	912.203
1821		BRANDES INSTITUTIONAL EQUITY TRUST	CARDARELLI ANGELO	122.949
1822		BRANDES INSTITUTIONAL EQUITY TRUST	CARDARELLI ANGELO	12.933
1865		BRANDES INSTITUTIONAL EQUITY TRUST	CARDARELLI ANGELO	29.200
1866		BRANDES INSTITUTIONAL EQUITY TRUST	CARDARELLI ANGELO	2.070
1488		BRANDES INSTITUTIONAL INTERNATIONAL EQUITY FUND	CARDARELLI ANGELO	1.147.284
1568		BRANDES INTERNATIONAL EQUITY FUND	CARDARELLI ANGELO	281.300
987		BRANDES INVESTMENT FUNDS PLC	CARDARELLI ANGELO	275.364
988		BRANDES INVESTMENT FUNDS PLC	CARDARELLI ANGELO	1.056.022
1950		BRANDES INVESTMENT PARTNERS, LP 401(K) PLAN	CARDARELLI ANGELO	15.875
1951		BRANDES INVESTMENT PARTNERS, LP 401(K) PLAN	CARDARELLI ANGELO	12.800
444		BRIDGE BUILDER INTERNATIONAL EQUITY FUND	CARDARELLI ANGELO	623.547
445		BRIDGE BUILDER INTERNATIONAL EQUITY FUND	CARDARELLI ANGELO	21.198
465		BRIDGEWATER TAILORED ALL WEATHER FUND, L.P	CARDARELLI ANGELO	907.833
1897		BRISTOL-MYERS SQUIBB COMPANY MASTER RETIREMENT TRUST	CARDARELLI ANGELO	39.659

Handwritten signature

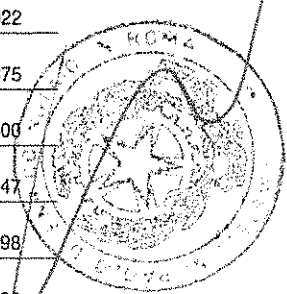

ASSEMBLEA ORDINARIA

81607/1050 12 MAGGIO 2016

Segreteria Societaria - Ufficio Titoli



eni

Unica convocazione

Esito della votazione sul punto 2

Attribuzione dell'utile di esercizio

Elenco Favorevoli

SCHEDA	VPC	NOMINATIVO AZIONISTA	DELEGATO	NUMERO DI AZIONI TOTALE
3148		BRITISH COLUMBIA INV.MAN.CORPORATION	CARDARELLI ANGELO	124.098
3149		BRITISH COLUMBIA INV.MAN.CORPORATION	CARDARELLI ANGELO	135.522
3150		BRITISH COLUMBIA INV.MAN.CORPORATION	CARDARELLI ANGELO	1.118.791
3151		BRITISH COLUMBIA INV.MAN.CORPORATION	CARDARELLI ANGELO	581.121
3203		BROWN BROTHERS HARRIMAN + CO, BOSTON CUSTODIAN FOR THE ADVISORS' INNER CIRCLE FUN	CARDARELLI ANGELO	55.888
1667		BRUNEI INVESTMENT AGENCY	CARDARELLI ANGELO	75.061
1678		BRUNEI INVESTMENT AGENCY	CARDARELLI ANGELO	150.840
2848		BRUNEI SHELL RETIREMENT BENEFIT FUND	CARDARELLI ANGELO	15.379
416		BRUNSWICK UNIT 2 QUALIFIED NUCLEAR DECOMMISSIONING FUND	CARDARELLI ANGELO	6.991
2906		BT EUROPEAN GROWTH FUND	CARDARELLI ANGELO	73.904
2910		BT INSTITUTIONAL CORE GLOBAL SHARE SECTO	CARDARELLI ANGELO	65.435
2908		BT INSTITUTIONAL INTERNATIONAL SHARE INT	CARDARELLI ANGELO	157.265
1731		BT INSTITUTIONAL INTERNATIONAL SUSTAINABILITY SHARE FUND	CARDARELLI ANGELO	74.802
2905		BT INTERNATIONAL FUND	CARDARELLI ANGELO	47.069
2907		BT WHOLESALE CORE HEDGED GLOBAL SHARE FU	CARDARELLI ANGELO	17.693
2879		BT WHOLESALE MULTI MANAG INTL SHARE FUND	CARDARELLI ANGELO	63.476
3062		BUREAU OF LABOR FUNDS- LABOR PENSION FUND	CARDARELLI ANGELO	8.614
3063		BUREAU OF LABOR FUNDS- LABOR PENSION FUND	CARDARELLI ANGELO	48.447
3069		BUREAU OF LABOR FUNDS- LABOR PENSION FUND	CARDARELLI ANGELO	123.246
3070		BUREAU OF LABOR FUNDS- LABOR PENSION FUND	CARDARELLI ANGELO	132.622
3071		BUREAU OF LABOR FUNDS- LABOR PENSION FUND	CARDARELLI ANGELO	33.336
3072		BUREAU OF LABOR FUNDS- LABOR PENSION FUND	CARDARELLI ANGELO	21.329
3064		BUREAU OF LABOR FUNDS-LABOR INSURANCE FUND	CARDARELLI ANGELO	41.718

ASSEMBLEA ORDINARIA 12 MAGGIO 2016

Segreteria Societaria - Ufficio Titoli



eni

Maggi

Unica convocazione

Esito della votazione sul punto 2

Attribuzione dell'utile di esercizio

81607/1051

Elenco Favorevoli

SCHEDA	VPC	NOMINATIVO AZIONISTA	DELEGATO	NUMERO DI AZIONI TOTALE
3065		BUREAU OF LABOR FUNDS-LABOR INSURANCE FUND CARDARELLI ANGELO		86.300
3066		BUREAU OF LABOR FUNDS-LABOR INSURANCE FUND CARDARELLI ANGELO		81.839
3067		BUREAU OF LABOR FUNDS-LABOR INSURANCE FUND CARDARELLI ANGELO		76.065
3068		BUREAU OF LABOR FUNDS-LABOR INSURANCE FUND CARDARELLI ANGELO		83.216
3074		BUREAU OF LABOR FUNDS-LABOR PENSION FUN CARDARELLI ANGELO		26.616
3075		BUREAU OF LABOR FUNDS-LABOR PENSION FUN CARDARELLI ANGELO		65.564
419		BURNSWICK UNIT 1 QUALIFIED NUCLEAR DECOMMISSIONING FUND CARDARELLI ANGELO		7.979
134		CAAM ACTIONS DURABLES CARDARELLI ANGELO		12
130		CAAM ACTIONS RESTRUCTURATIONS CARDARELLI ANGELO		21.715
140		CAAM RESA ACTIONS EURO CARDARELLI ANGELO		46.000
131		CAAM SELECT EURO CARDARELLI ANGELO		11
1014		CAISSE DE DEPOT ET PLACEMENT DU QUEBEC CARDARELLI ANGELO		1.567.426
1015		CAISSE DE DEPOT ET PLACEMENT DU QUEBEC CARDARELLI ANGELO		12.472.800
2499		CAISSE DES DEPOTS ET CONSIGNATIONS CARDARELLI ANGELO		9.653.819
2500		CAISSE DES DEPOTS ET CONSIGNATIONS CARDARELLI ANGELO		7.142.529
1896		CALIFORNIA PHYSICIANS SERVICE D/B/A BLUE SHIELD OF CALIFORNIA CARDARELLI ANGELO		134.067
1237		CALIFORNIA PUBLIC EMPLOYEES RETIREMENT SYSTEM CARDARELLI ANGELO		5.853.526
1238		CALIFORNIA PUBLIC EMPLOYEES RETIREMENT SYSTEM CARDARELLI ANGELO		1.588.532
1239		CALIFORNIA PUBLIC EMPLOYEES RETIREMENT SYSTEM CARDARELLI ANGELO		795.399
1240		CALIFORNIA PUBLIC EMPLOYEES RETIREMENT SYSTEM CARDARELLI ANGELO		183.986
1241		CALIFORNIA PUBLIC EMPLOYEES RETIREMENT SYSTEM CARDARELLI ANGELO		26.117
1243		CALIFORNIA STATE TEACHERS RETIREMENT SYSTEM CARDARELLI ANGELO		110.767
1244		CALIFORNIA STATE TEACHERS RETIREMENT SYSTEM CARDARELLI ANGELO		1.362.924

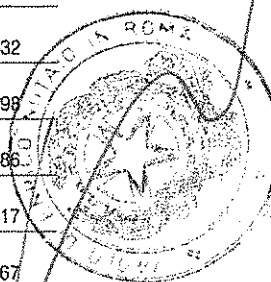

ASSEMBLEA ORDINARIA

81607/1052 12 MAGGIO 2016

Segreteria Societaria - Ufficio Titoli



eni

Unica convocazione

Esito della votazione sul punto 2

Attribuzione dell'utile di esercizio

Elenco Favorevoli

SCHEDA	VPC	NOMINATIVO AZIONISTA	DELEGATO	NUMERO DI AZIONI TOTALE
1245		CALIFORNIA STATE TEACHERS RETIREMENT SYSTEM CARDARELLI ANGELO		878.817
1246		CALIFORNIA STATE TEACHERS RETIREMENT SYSTEM CARDARELLI ANGELO		123.112
1577		CALIFORNIA STATE TEACHERS RETIREMENT SYSTEM CARDARELLI ANGELO		226.278
1578		CALIFORNIA STATE TEACHERS RETIREMENT SYSTEM CARDARELLI ANGELO		702.359
1579		CALIFORNIA STATE TEACHERS RETIREMENT SYSTEM CARDARELLI ANGELO		1.141.130
1580		CALIFORNIA STATE TEACHERS RETIREMENT SYSTEM CARDARELLI ANGELO		106.484
1581		CALIFORNIA STATE TEACHERS RETIREMENT SYSTEM CARDARELLI ANGELO		1.030.516
1011		CALVERT VP EAFE INTERNATIONAL INDEX PORTFOLIO CARDARELLI ANGELO		31.366
2231		CAMBRIA GLOBAL VALUE ETF CARDARELLI ANGELO		37.368
2473		CAMGESTION DEEP VALUE CARDARELLI ANGELO		275.747
1952		CAMPBELL PENSION PLANS MASTER RETIREMENT TRUST CARDARELLI ANGELO		33.748
72		CANADA LIFE ASSURANCE EUROP LIMITED CARDARELLI ANGELO		1.902.642
1145		CANADA PENSION PLAN INVESTMENT BOARD CARDARELLI ANGELO		48.930
1146		CANADA PENSION PLAN INVESTMENT BOARD CARDARELLI ANGELO		3.929.406
512		CANADIAN PACIFIC RAILWAY COMPANY PENSION PLAN CARDARELLI ANGELO		387.373
228		CANDLES PROVIDENT PENSION FUND CARDARELLI ANGELO		3.702
3298		CANDRIAM EQUITIES B SA CARDARELLI ANGELO		30.689
2745		CANDRIAM EQUITIES L CARDARELLI ANGELO		197.346
2746		CANDRIAM FUND CARDARELLI ANGELO		40.067
2744		CANDRIAM SRI CARDARELLI ANGELO		12.498
2726		CAPACITY FONDS INSTITUTIONEL-ACTIONS ETRANGERES PIB CARDARELLI ANGELO		35.739
2851		CAPITAL GROUP ABSOLUTE INCOME GROWER COM CARDARELLI ANGELO		12.137
3103		CAPITAL GROUP EMPLOYEE BENEFIT INV.TRUST CARDARELLI ANGELO		15.779

ASSEMBLEA ORDINARIA 12 MAGGIO 2016

Segreteria Societaria - Ufficio Titoli



eni

81607/1053

M. M.

Unica convocazione

Esito della votazione sul punto 2

Attribuzione dell'utile di esercizio

Elenco Favorevoli

SCHEDA	VPC	NOMINATIVO AZIONISTA	DELEGATO	NUMERO DI AZIONI TOTALE
3094		CAPITAL GROUP INTERNATIONAL INC	CARDARELLI ANGELO	5.719
2779		CAPITAL GROWTH FUND ABSOLUTE INCOME GROW	CARDARELLI ANGELO	8.648
2896		CAPITAL INCOME BUILDER INC	CARDARELLI ANGELO	5.436.000
2772		CAPITAL INTERNATIONAL FUND	CARDARELLI ANGELO	171.500
2784		CAPITAL INTERNATIONAL FUND	CARDARELLI ANGELO	125.000
2893		CAPITAL WORLD GROWTH & INCOME FUND INC	CARDARELLI ANGELO	13.395.300
2875		CARBON AWARE INTERNATIONAL SHARES FUND	CARDARELLI ANGELO	22.753
797		CARBP DIVERSIFIE	CARDARELLI ANGELO	55.983
778		CARP - INDO	CARDARELLI ANGELO	146.233
249		CARPENTERS PENSION TRUST FUND OF ST.LUIS	CARDARELLI ANGELO	103.769
2258		CASSETTE DIVERSIFIE	CARDARELLI ANGELO	65.019
1899		CATERPILLAR INC MASTER RETIREMENT TRUST	CARDARELLI ANGELO	842.418
1900		CATERPILLAR INC. GROUP INSURANCE PLAN TRUST	CARDARELLI ANGELO	46.737
1898		CATERPILLAR INVESTMENT TRUST	CARDARELLI ANGELO	189.262
853		CAVENDISH SYSTEMATIC FUND	CARDARELLI ANGELO	22.333
59		CBO SUPERANNUATION CORPORATION PTY LTD	CARDARELLI ANGELO	30.973
648		CC & L INTERNATIONAL EQUITY FUND	CARDARELLI ANGELO	50.100
649		CC&L GLOBAL EQUITY FUND	CARDARELLI ANGELO	188.200
650		CC&L Q GROUP GLOBAL EQUITY FUND	CARDARELLI ANGELO	151.100
318		CCA CORE RETURN FUND	CARDARELLI ANGELO	376
513		CCNPP, INC. MASTER DECOMM TRUST UNIT ONE QUALIFIED FUND	CARDARELLI ANGELO	10.600
514		CCNPP, INC. MASTER DECOMM TRUST UNIT ONE QUALIFIED FUND	CARDARELLI ANGELO	12.500
1445		CDN ACWI ALPHA TILTS FUND	CARDARELLI ANGELO	22.753

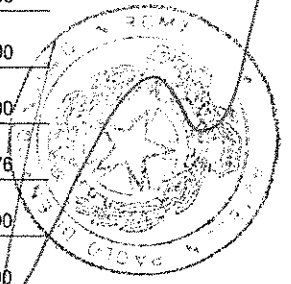

ASSEMBLEA ORDINARIA

81607/1054 12 MAGGIO 2016

Segreteria Societaria - Ufficio Titoli



eni

Unica convocazione

Esito della votazione sul punto 2

Attribuzione dell'utile di esercizio

Elenco Favorevoli

SCHEDA	VPC	NOMINATIVO AZIONISTA	DELEGATO	NUMERO DI AZIONI TOTALE
1984		CENTERPOINT ENERGY, INC. MASTER RETIREMENT TRUST	CARDARELLI ANGELO	34.006
1480		CENTRAL PENSION F OF INT UNION OF OPERAT & PART EMPL	CARDARELLI ANGELO	149.004
997		CENTRAL PROVIDENT FUND BOARD	CARDARELLI ANGELO	22.021
998		CENTRAL PROVIDENT FUND BOARD	CARDARELLI ANGELO	27.900
1163		CERN PENSION FUND	CARDARELLI ANGELO	250.000
1167		CERN PENSION FUND	CARDARELLI ANGELO	190.529
1010		CERTAS HOME AND AUTO INSURANCE COMPANY	CARDARELLI ANGELO	20.643
311		CF CANLIFE GLOBAL EQUITY INCOME FUND	CARDARELLI ANGELO	81.134
715		CF INTERNATIONAL STOCK INDEX FUND ONE	CARDARELLI ANGELO	160.658
51		CFSIL - COLONIAL FIRST STATE GLOBAL ASSET MANAGEMENT MULTI SECTOR TRUST 1	CARDARELLI ANGELO	1.036
77		CFSIL RE COLONIAL FIRST STATE INVESTMENT FUND 10	CARDARELLI ANGELO	70.555
892		CGE INVESTMENTS (NO. 2) S.A.R.L.	CARDARELLI ANGELO	41.271
970		CHANG HWA COMM BK AMCO ING CHB GLOBAL HIGH DIVIDEND FUND	CARDARELLI ANGELO	27.232
723		CHAUTAUQUA GLOBAL GROWTH EQUITY QO FUND LP	CARDARELLI ANGELO	11.160
713		CHAUTAUQUA INTERNATIONAL GROWTHEQUITY QP FUND LP	CARDARELLI ANGELO	81.609
2234		CHERRY TREE FUND OF AMERICAN	CARDARELLI ANGELO	186.306
1803		CHESS INTERNATIONAL PROPERTIES, LTD.	CARDARELLI ANGELO	3.172
1658		CHEVRON MASTER PENSION TRUST	CARDARELLI ANGELO	20.120
1659		CHEVRON MASTER PENSION TRUST	CARDARELLI ANGELO	147.706
1782		CHEVRON UK PENSION PLAN	CARDARELLI ANGELO	5.709
1901		CHILDREN'S HEALTHCARE OF ATLANTA, INC.	CARDARELLI ANGELO	87.976
2860		CHINA LIFE INSURANCE (GROUP) COMPANY	CARDARELLI ANGELO	7.186
2859		CHINA LIFE INSURANCE COMPANY LIMITED	CARDARELLI ANGELO	45.565

ASSEMBLEA ORDINARIA 12 MAGGIO 2016

Segreteria Societaria - Ufficio Titoli



eni

81607/1055

M...

Unica convocazione

Esito della votazione sul punto 2

Attribuzione dell'utile di esercizio

Elenco Favorevoli

SCHEDA	VPC	NOMINATIVO AZIONISTA	DELEGATO	NUMERO DI AZIONI TOTALE
2862		CHINA LIFE INSURANCE COMPANY LIMITED	CARDARELLI ANGELO	95.760
1267		CHINATRUST CB AMCO FAR EASTERN ALL GLOB MATERIALS & ENERGY F	CARDARELLI ANGELO	23.676
1783		CHRISTIAN SCHOOL PENSION PLAN AND TRUST FUND	CARDARELLI ANGELO	99.375
1489		CHRYSLER LLC MASTER RETIREMENT TRUST	CARDARELLI ANGELO	101.120
45		CHUNGHWA POST CO LTD	CARDARELLI ANGELO	45.795
2953		CHURCH COMMISSIONERS FOR ENGLAND	CARDARELLI ANGELO	13.393
2020		CHURCH OF ENGLAND INVESTMENT FUND FOR PENSIONS	CARDARELLI ANGELO	54.052
707		CIBC EUROPEAN INDEX FUND	CARDARELLI ANGELO	15.103
706		CIBC INTERNATIONAL INDEX FUND	CARDARELLI ANGELO	38.160
708		CIBC POOLED INTERNATIONAL EQUITY INDEX FUND	CARDARELLI ANGELO	36.673
3255		CIDEL BANK & TRUST INC AS TRUSTEE NOM-DBB-HEXA	CARDARELLI ANGELO	3.170
1856		CINDY SPRINGS, LLC	CARDARELLI ANGELO	4.659
1857		CINDY SPRINGS, LLC	CARDARELLI ANGELO	39.959
35		CITIBANK KOREA INC	CARDARELLI ANGELO	1.151.974
741		CITIGROUP PENSION PLAN	CARDARELLI ANGELO	64.356
28		CITITRUST LTD	CARDARELLI ANGELO	120.450
33		CITITRUST LTD	CARDARELLI ANGELO	15.088
428		CITW FUND, LP	CARDARELLI ANGELO	8.378
517		CITY OF CINCINNATI RETIREMENT SYSTEM	CARDARELLI ANGELO	164.096
1827		CITY OF CLEARWATER EMPLOYEE'S PENSION FUND	CARDARELLI ANGELO	23.900
1520		CITY OF HIALEAH EMPLOYEES' RETIREMENT SYSTEM	CARDARELLI ANGELO	25.225
1788		CITY OF LOS ANGELES FIRE AND POLICE PENSION PLAN	CARDARELLI ANGELO	1.607.691
1789		CITY OF LOS ANGELES FIRE AND POLICE PENSION PLAN	CARDARELLI ANGELO	136.718

am

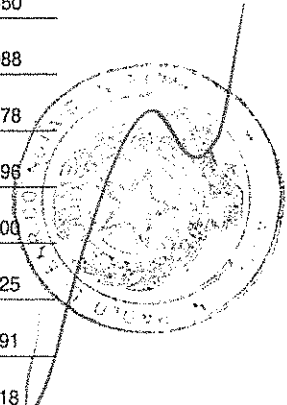

81507/1056 ASSEMBLEA ORDINARIA
12 MAGGIO 2016

Segreteria Societaria - Ufficio Titoli



eni

Unica convocazione

Esito della votazione sul punto 2

Attribuzione dell'utile di esercizio

Elenco Favorevoli

SCHEDA	VPC	NOMINATIVO AZIONISTA	DELEGATO	NUMERO DI AZIONI TOTALE
1790		CITY OF LOS ANGELES FIRE AND POLICE PENSION PLAN	CARDARELLI ANGELO	136.642
1953		CITY OF MILWAUKEE EMPLOYES RETIREMENT SYSTEM	CARDARELLI ANGELO	727.539
626		CITY OF NEW YORK DEFERRED COMPENSATION PLAN	CARDARELLI ANGELO	578.174
1151		CITY OF NEW YORK GROUP TRUST	CARDARELLI ANGELO	115.683
1152		CITY OF NEW YORK GROUP TRUST	CARDARELLI ANGELO	92.224
1153		CITY OF NEW YORK GROUP TRUST	CARDARELLI ANGELO	220.236
1576		CITY OF PROVIDENCE EMPLOYEES RETIREMENT SYSTEM	CARDARELLI ANGELO	69.607
759		CL EPARGNE DYNAMIQUE	CARDARELLI ANGELO	13.248
257		CLAYMORE ZACHS INTERNATIONAL MULTI ASSET INCOME INDEX ETF	CARDARELLI ANGELO	5.690
499		CLEVELAND CLINIC HEALTH SYSTEM PENSION TRUST	CARDARELLI ANGELO	1.288
3226		CM EUROPE ACTIONS	CARDARELLI ANGELO	74.405
507		CN CANADIAN MASTER TRUST FUND	CARDARELLI ANGELO	2.722
786		CNP ACP ACTIONS LT	CARDARELLI ANGELO	53.023
150		CNP ASSUR VALEURS	CARDARELLI ANGELO	17.763
179		CNP ASSURANCES SA	CARDARELLI ANGELO	35.261
180		CNP ASSURANCES SA	CARDARELLI ANGELO	210.616
181		CNP ASSURANCES SA	CARDARELLI ANGELO	4.125.000
182		CNP ASSURANCES SA	CARDARELLI ANGELO	533.546
183		CNP ASSURANCES SA	CARDARELLI ANGELO	20.678
184		CNP ASSURANCES SA	CARDARELLI ANGELO	1.189.898
185		CNP ASSURANCES SA	CARDARELLI ANGELO	64.000
186		CNP ASSURANCES SA	CARDARELLI ANGELO	52.220
187		CNP ASSURANCES SA	CARDARELLI ANGELO	153.406

ASSEMBLEA ORDINARIA 12 MAGGIO 2016

Segreteria Societaria - Ufficio Titoli



81607/1057

M

2

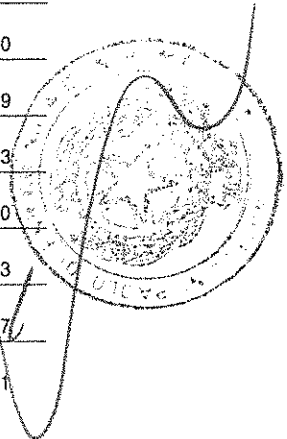

Unica convocazione

Esito della votazione sul punto 2

Attribuzione dell'utile di esercizio

Elenco Favorevoli

SCHEDA	VPC	NOMINATIVO AZIONISTA	DELEGATO	NUMERO DI AZIONI TOTALE
188	CNP ASSURANCES SA		CARDARELLI ANGELO	41.755
189	CNP ASSURANCES SA		CARDARELLI ANGELO	4.257.206
190	CNP ASSURANCES SA		CARDARELLI ANGELO	29.155
191	CNP ASSURANCES SA		CARDARELLI ANGELO	736.181
192	CNP ASSURANCES SA		CARDARELLI ANGELO	24.145
193	CNP ASSURANCES SA		CARDARELLI ANGELO	58.945
194	CNP ASSURANCES SA		CARDARELLI ANGELO	8.126
2868	COINVEST LIMITED		CARDARELLI ANGELO	18.565
2494	COLISEE IFC 1 FCP		CARDARELLI ANGELO	200.000
1510	COLLEGE RETIREMENT EQUITIES FUND		CARDARELLI ANGELO	2.339.753
1511	COLLEGE RETIREMENT EQUITIES FUND		CARDARELLI ANGELO	853.353
506	COLLEGES OF APPLIED ARTS AND TECHNOLOGY PENSION P		CARDARELLI ANGELO	328.565
26	COLONIAL FIRST STATE		CARDARELLI ANGELO	27.982
29	COLONIAL FIRST STATE INVESTMENTS LIMITED.		CARDARELLI ANGELO	65.143
30	COLONIAL FIRST STATE INVESTMENTS LIMITED.		CARDARELLI ANGELO	120.326
42	COLONIAL FIRST STATE INVESTMENTS LIMITED.		CARDARELLI ANGELO	449.056
43	COLONIAL FIRST STATE INVESTMENTS LIMITED.		CARDARELLI ANGELO	278.020
27	COLONIAL FIRST STATE INVESTMENTS LTD		CARDARELLI ANGELO	9.259
55	COLONIAL FIRST STATE INVESTMENTS LTD		CARDARELLI ANGELO	61.993
3119	COLUMBIA DIVIDEND OPPORTUNITY FUND		CARDARELLI ANGELO	1.412.620
3095	COLUMBIA MULTI-ASSET INCOME FUND		CARDARELLI ANGELO	1.623
3118	COLUMBIA VARIABLE PORTF.-DIVIDEND OPPORT		CARDARELLI ANGELO	556.017
994	COMBUSTION ENGINEERING 524(G) ASBESTOS PI TRUST		CARDARELLI ANGELO	9.241

ASSEMBLEA ORDINARIA

81607/1058 12 MAGGIO 2016

Segreteria Societaria - Ufficio Titoli



eni

Unica convocazione

Esito della votazione sul punto 2

Attribuzione dell'utile di esercizio

Elenco Favorevoli

SCHEDA	VPC	NOMINATIVO AZIONISTA	DELEGATO	NUMERO DI AZIONI TOTALE
2852		COMMINGLED PENSION FUND ENHANCED INDEX)	CARDARELLI ANGELO	2.617
1603		COMMON TRUST ITALY FUND	CARDARELLI ANGELO	2.357.237
1001		COMMONFUND DIRECT SERIES LLC - CF T. ROWE PRICE EURO EQT SERIE	CARDARELLI ANGELO	93.372
951		COMMONFUND INTERNATIONAL FOCUS FUND I, LLC	CARDARELLI ANGELO	41.909
2044		COMMONWEALTH GLOBAL SHARE FUND 29	CARDARELLI ANGELO	3.093
567		COMMONWEALTH OF PENNSYLVANIA TRAEASURY DEPT.	CARDARELLI ANGELO	26.001
508		COMMONWEALTH OF PENNSYLVANIA PUBLIC SCHOOL EMPLOYEES RETIREMENTENT SYSTEM	CARDARELLI ANGELO	479.687
509		COMMONWEALTH OF PENNSYLVANIA STATE EMPLOYEES RETIREMENT SYSTEM.	CARDARELLI ANGELO	103.982
510		COMMONWEALTH OF PENNSYLVANIA STATE EMPLOYEES RETIREMENT SYSTEM.	CARDARELLI ANGELO	501.546
511		COMMONWEALTH OF PENNSYLVANIA STATE EMPLOYEES RETIREMENT SYSTEM.	CARDARELLI ANGELO	378.712
1890		COMMONWEALTH SUPERANN CORP ATF ARIA INVESTMENTS TR	CARDARELLI ANGELO	209.900
1514		CONAGRA FOODS MASTER PENSION TRUST	CARDARELLI ANGELO	155.381
787		CONCORDE 96	CARDARELLI ANGELO	30.125
2866		CONNECTICUT GENERAL LIFE INSURANCE COMPA	CARDARELLI ANGELO	29.305
2867		CONNECTICUT GENERAL LIFE INSURANCE COMPA	CARDARELLI ANGELO	30.800
1440		CONNECTICUT GENERAL LIFE INSURANCE COMPANY	CARDARELLI ANGELO	11.208
1553		CONSOLIDATED EDISON RETIREMENT PLAN	CARDARELLI ANGELO	300.950
2835		CONSTRUCTION AND BUILDING UNIONS SUPERAN	CARDARELLI ANGELO	66.300
2472		CONTI FLEXIBLE	CARDARELLI ANGELO	26.919
1154		COSMOPOLITAN INVESTMENT FUND	CARDARELLI ANGELO	26.145
1155		COSMOPOLITAN INVESTMENT FUND	CARDARELLI ANGELO	4.553
1157		COSMOPOLITAN INVESTMENT FUND	CARDARELLI ANGELO	60.256
1158		COSMOPOLITAN INVESTMENT FUND	CARDARELLI ANGELO	3.371

ASSEMBLEA ORDINARIA 12 MAGGIO 2016

Segreteria Societaria - Ufficio Titoli



eni

81607/1059

Murphy

Unica convocazione

Esito della votazione sul punto 2

Attribuzione dell'utile di esercizio

Elenco Favorevoli

SCHEDA	VPC NOMINATIVO AZIONISTA	DELEGATO	NUMERO DI AZIONI TOTALE
492	COUNTY AND MUNICIPAL GOVT CAPITAL IMPROVEMENT TRUST FUND CARDARELLI ANGELO		29.400
530	COUNTY EMPLOYEES ANNUITY AND BENEFIT FUND OF COOK COUNTY CARDARELLI ANGELO		98.997
581	COUNTY OF LOS ANGELES SAVINGS PLAND THRIFT PLAN CARDARELLI ANGELO		56.744
852	CPPIB MAP CAYMAN SPC. ON BEHALF OF AND FOR THE ACCOUNT OF SEGREGATED PORTFOLIO D. CARDARELLI ANGELO		46.756
151	CPR EUROLAND CARDARELLI ANGELO		523.441
147	CROISSANCE DIVERSIFIE CARDARELLI ANGELO		2.653
1753	CSAA INSURANCE EXCHANGE CARDARELLI ANGELO		171.516
1754	CULTURAL INSTITUTIONS PENSION PLAN TRUST CARDARELLI ANGELO		19.936
1955	CUMMINS INC. AND AFFILIATES COLLECTIVE INVESTMENT TRUST CARDARELLI ANGELO		60.345
2728	Capacity Fonds Institutionnel Actions Etrangeres CARDARELLI ANGELO		9.016
3200	D.E SHAW COUNTRY GLOBAL ALPHA EXTENSION PORTFOLIOS LLC CARDARELLI ANGELO		1.849
2260	DARWIN DIVERSIFIE 60-80 ACTION CARDARELLI ANGELO		13.805
2261	DARWIN DIVERSIFIE 80-100 ACT CARDARELLI ANGELO		41.394
524	DAUGHTERS OF CHARITY OF ST VINCENT DE PAUL PROVINCE OF THE WEST CARDARELLI ANGELO		72.656
335	DB X TRACKERS MSCI EUROPE EQUITY CARDARELLI ANGELO		1.096.332
2593	DBI FONDS EKIBB CARDARELLI ANGELO		24.140
3199	DE SHAW VALUE ALL COUNTRY ALPHA EXTENSION FUND CARDARELLI ANGELO		114.231
3217	DEAM FONDS ROCK CARDARELLI ANGELO		88.088
3243	DEAM FONDS VVK 2 CARDARELLI ANGELO		7.540
389	DEAM-FONDS DCG EQ DEAM-FONDS DCG EQ CARDARELLI ANGELO		21.894
387	DEAM-FONDS MMM SPEZIAL . CARDARELLI ANGELO		42.609
1401	DEAWM FOR OPPENHEIM DYNAMIC EUROPE BALANCE CARDARELLI ANGELO		43.161
1184	DEAWM INV GMBH FOR DEAM-FONDS CPT CARDARELLI ANGELO		17.500

Handwritten signature

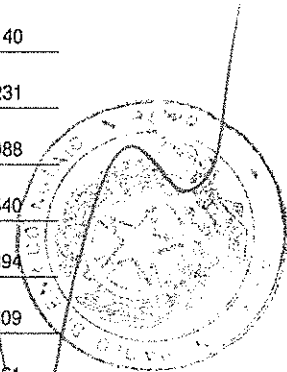

ASSEMBLEA ORDINARIA

81607/1060 12 MAGGIO 2016

Segreteria Societaria - Ufficio Titoli



eni

Unica convocazione

Esito della votazione sul punto 2

Attribuzione dell'utile di esercizio

Elenco Favorevoli

SCHEDA	VPC	NOMINATIVO AZIONISTA	DELEGATO	NUMERO DI AZIONI TOTALE
1404		DEAWM INV GMBH FOR DEUTSCHE QUANT EQUITY EUROPE	CARDARELLI ANGELO	28.268
1396		DEAWM INVESTMENT GMBH FOR ALBATROS FONDS OP	CARDARELLI ANGELO	13.592
1185		DEAWM INVESTMENT GMBH FOR DEAWM-FONDS HED	CARDARELLI ANGELO	12.000
1186		DEAWM INVESTMENT GMBH FOR DEAWM-FONDS HED	CARDARELLI ANGELO	11.500
1395		DEAWM INVESTMENT GMBH FOR VERMOEGENSMANAGEMENT RENDITE OP	CARDARELLI ANGELO	108.025
2734		DEFINED BENEFIT PP FOR CHUGOKU ELECT	CARDARELLI ANGELO	14.548
2353		DEGROOF EQ. EMU HIGH DY	CARDARELLI ANGELO	290.000
2806		DEKA BASISSTRATEGIE FLEXIBEL	CARDARELLI ANGELO	6.800
3012		DEKA FUND INVESTMENT RE/ A-HORCH-FONDS	CARDARELLI ANGELO	173.100
2992		DEKA FUNDMASTER INVESTMENTGESELLSCHAFT M	CARDARELLI ANGELO	2.940
3049		DEKA INTERNATIONAL S.A RE DEKALUX-EUROPA	CARDARELLI ANGELO	175.000
3056		DEKA INTERNATIONAL S.A. RE DEKA PRIVATE	CARDARELLI ANGELO	2.400
3054		DEKA INTERNATIONAL S.A. RE DEKA-EUROPAVA	CARDARELLI ANGELO	45.670
3055		DEKA INTERNATIONAL S.A. RE DEKA-EUROSTOC	CARDARELLI ANGELO	360.000
3057		DEKA INTERNATIONAL S.A. RE DEKALUX-GLOBA	CARDARELLI ANGELO	122.908
2986		DEKA INTL S.A GLOBALE AKTIEN LOWRISK	CARDARELLI ANGELO	14.770
3005		DEKA INV. GMBH RE A-GOLDENE AUE-FONDS	CARDARELLI ANGELO	40.000
3004		DEKA INV. GMBH RE BAUTZEN FUNDMASTER	CARDARELLI ANGELO	62.300
3001		DEKA INV. RE A-STENDALER-ROLANDFONDS I	CARDARELLI ANGELO	15.000
2807		DEKA INVEST DEKA EURO STOXX 50 - UCITS	CARDARELLI ANGELO	14.638
2826		DEKA INVEST DEKA EURO STOXX 50 - UCITS	CARDARELLI ANGELO	1.252.675
2824		DEKA INVEST DIVIDENDENSTRATEGIE CF A	CARDARELLI ANGELO	908.400
2995		DEKA INVEST GMBH RE A-MUEHLEN FONDS	CARDARELLI ANGELO	40.000

ASSEMBLEA ORDINARIA 12 MAGGIO 2016

Segreteria Societaria - Ufficio Titoli



eni

81607/1061

M. ...

Unica convocazione

Esito della votazione sul punto 2

Attribuzione dell'utile di esercizio

Elenco Favorevoli

SCHEDA	VPC	NOMINATIVO AZIONISTA	DELEGATO	NUMERO DI AZIONI TOTALE
2989		DEKA INVEST GMBH RE A-VSA-FONDS	CARDARELLI ANGELO	41.332
3006		DEKA INVEST GMBH RE AGR DENA I	CARDARELLI ANGELO	8.590
3021		DEKA INVEST GMBH RE BODENSEE-FONDS	CARDARELLI ANGELO	1.300
2812		DEKA INVEST GMBH RE DEKA-BAV-FONDS	CARDARELLI ANGELO	49.050
2816		DEKA INVEST GMBH RE DEKA-BR 85	CARDARELLI ANGELO	61.205
2822		DEKA INVEST GMBH RE DEKA-PB DEFENSIV	CARDARELLI ANGELO	7.903
3008		DEKA INVEST GMBH RE PRHL 1-FONDS	CARDARELLI ANGELO	16.000
2828		DEKA INVEST GMBH RE STOXX EUROPE 50 ETF	CARDARELLI ANGELO	23.694
2997		DEKA INVEST GMBH re SPKED 01 FONDS	CARDARELLI ANGELO	20.300
3018		DEKA INVEST MAULBRONN-STROMBERG-FONDS	CARDARELLI ANGELO	18.950
2993		DEKA INVEST RE A-CRISPINUS FOND	CARDARELLI ANGELO	5.000
2821		DEKA INVEST RE DEKA-EUROLAND BALANCE	CARDARELLI ANGELO	1.104.300
3009		DEKA INVEST RE DEKA-ZMV-FONDS	CARDARELLI ANGELO	9.100
3017		DEKA INVEST RE KOMMUNAL-TUT-BALANCED -FO	CARDARELLI ANGELO	17.050
2813		DEKA INVEST RE MEGATRENDS CF	CARDARELLI ANGELO	47.000
2814		DEKA INVEST RE SIGMA PLUS KONSERVATIV	CARDARELLI ANGELO	11.074
2990		DEKA INVEST RE VSINVESTMENT GOCH-FONDS	CARDARELLI ANGELO	80.000
2829		DEKA INVEST RE/DEKA-GLOBAL CHAMPIONS	CARDARELLI ANGELO	75.000
3010		DEKA INVEST REGIONALE-WUPPERTAL-FONDS	CARDARELLI ANGELO	6.822
3016		DEKA INVEST. GMBH RE A-KLB-MASTERFONDS	CARDARELLI ANGELO	366.000
2811		DEKA INVEST. RE DEKA-DIVIDENDENDISCOUNT	CARDARELLI ANGELO	9.100
2998		DEKA INVEST.GMBH RE A-HAM-FONDS	CARDARELLI ANGELO	16.400
3000		DEKA INVEST.GMBH RE SVN II FONDS	CARDARELLI ANGELO	7.338

M. ...

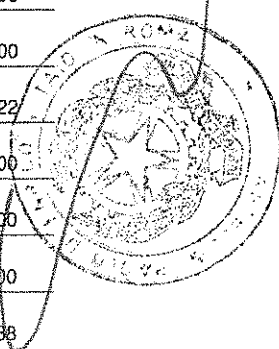

ASSEMBLEA ORDINARIA

81607/1062 12 MAGGIO 2016

Segreteria Societaria - Ufficio Titoli



eni

Unica convocazione

Esito della votazione sul punto 2

Attribuzione dell'utile di esercizio

Elenco Favorevoli

SCHEDA	VPC	NOMINATIVO AZIONISTA	DELEGATO	NUMERO DI AZIONI TOTALE
2825		DEKA INVESTGMBH RE MSCI EUROPE LC UCITS	CARDARELLI ANGELO	13.466
2991		DEKA INVESTMENT A-WITTRING MASTER FONDS	CARDARELLI ANGELO	3.150
2827		DEKA INVESTMENT GMBH DEKA MSCI EUROPE UC	CARDARELLI ANGELO	73.681
917		DEKA INVESTMENT GMBH FOR FTS-FONDS	CARDARELLI ANGELO	66.499
1022		DEKA INVESTMENT GMBH FOR VEW-FONDS	CARDARELLI ANGELO	11.017
3023		DEKA INVESTMENT GMBH RE A-AMISIA-FONDS	CARDARELLI ANGELO	27.000
3024		DEKA INVESTMENT GMBH RE A-ASD FONDS	CARDARELLI ANGELO	9.900
3003		DEKA INVESTMENT GMBH RE A-KSK FULDA-FOND	CARDARELLI ANGELO	10.500
3026		DEKA INVESTMENT GMBH RE A-SKGO-FONDS	CARDARELLI ANGELO	7.500
2999		DEKA INVESTMENT GMBH RE BRODO INVEST	CARDARELLI ANGELO	5.148
3048		DEKA INVESTMENT GMBH RE DEKA EURO ISTOXX	CARDARELLI ANGELO	281.885
2805		DEKA INVESTMENT GMBH RE DEKA-BASIS	CARDARELLI ANGELO	10.000
2815		DEKA INVESTMENT GMBH RE DEKA-BR 100	CARDARELLI ANGELO	301.806
3020		DEKA INVESTMENT GMBH RE DEKA-BR 20	CARDARELLI ANGELO	3.539
2819		DEKA INVESTMENT GMBH RE DEKA-BR 35	CARDARELLI ANGELO	17.855
2818		DEKA INVESTMENT GMBH RE DEKA-BR 55	CARDARELLI ANGELO	8.171
2817		DEKA INVESTMENT GMBH RE DEKA-BR 75	CARDARELLI ANGELO	37.884
2808		DEKA INVESTMENT GMBH RE DEKA-DIVIDEND VA	CARDARELLI ANGELO	75.800
2820		DEKA INVESTMENT GMBH RE DEKAFUTUR-CHANCE	CARDARELLI ANGELO	17.000
2809		DEKA INVESTMENT GMBH RE DEKASPEZIAL	CARDARELLI ANGELO	90.351
3025		DEKA INVESTMENT GMBH RE LANDSBERG-FONDS	CARDARELLI ANGELO	11.600
2994		DEKA INVESTMENT GMBH RE PFRUENDE INVEST	CARDARELLI ANGELO	6.450
3007		DEKA INVESTMENT GMBH RE PRODEKA	CARDARELLI ANGELO	178.000

ASSEMBLEA ORDINARIA 12 MAGGIO 2016

Segreteria Societaria - Ufficio Titoli



81607/1063

M...

Unica convocazione

Esito della votazione sul punto 2

Attribuzione dell'utile di esercizio

Elenco Favorevoli

SCHEDA	VPC	NOMINATIVO AZIONISTA	DELEGATO	NUMERO DI AZIONI TOTALE
3013		DEKA INVESTMENT GMBH RE SAPHIR-FONDS	CARDARELLI ANGELO	11.000
3011		DEKA INVESTMENT GMBH RE STADTBAHN-FONDS	CARDARELLI ANGELO	5.033
2987		DEKA INVESTMENT GMBH RE SVN-FONDS	CARDARELLI ANGELO	6.350
3002		DEKA INVESTMENT GMBH RE WESPA-MASTERFOND	CARDARELLI ANGELO	63.025
3015		DEKA INVESTMENT MBH RE PKBMF	CARDARELLI ANGELO	21.350
3014		DEKA INVESTMENTMBH RE DONAU-FUNDMASTER	CARDARELLI ANGELO	40.000
2540		DEKA MASTER HAEK I	CARDARELLI ANGELO	65.873
2541		DEKA MASTER HAEK I	CARDARELLI ANGELO	139.182
3050		DEKA NACHHALTIGKEIT BALANCE CF (A)	CARDARELLI ANGELO	45.000
735		DELAWARE GROUP FOUNDATION FUNDSDELAWARE FOUNDATION GROWTH ALLOCATION FUNDS	CARDARELLI ANGELO	525.208
1012		DELUXE CORPORATION MASTER TRUST	CARDARELLI ANGELO	46.331
526		DENVER EMPLOYEES RETIREMENT PLAN	CARDARELLI ANGELO	77.672
1005		DESJARDINS ASSURANCES GENERALES INC.	CARDARELLI ANGELO	10.124
1002		DESJARDINS DIVIDEND INCOME FUND	CARDARELLI ANGELO	37.600
1009		DESJARDINS IBRIX GLOBAL EQUITY FOCUS FUND	CARDARELLI ANGELO	953
1003		DESJARDINS SECURITE FINANCIERE COMPAGNIE D'ASSURANCE VIE	CARDARELLI ANGELO	8.159
1004		DESJARDINS SECURITE FINANCIERE COMPAGNIE D'ASSURANCE VIE	CARDARELLI ANGELO	21.073
1008		DESJARDINS SECURITE FINANCIERE COMPAGNIE D'ASSURANCE VIE	CARDARELLI ANGELO	6.105
1162		DEUT ASS & WEALTH MNGM INV GMBH FOR DEAM CAP PROTECT AKTIEN	CARDARELLI ANGELO	239
1168		DEUT ASS & WEALTH MNGM INV GMBH FOR DEAM-FONDS AKTIEN-BM-F I	CARDARELLI ANGELO	35.000
1177		DEUT ASS & WEALTH MNGM INV GMBH FOR DEAM-FONDS AVD 2	CARDARELLI ANGELO	6.985
1171		DEUT ASS & WEALTH MNGM INV GMBH FOR DEAM-FONDS BBR 1	CARDARELLI ANGELO	43.200
952		DEUT ASS & WEALTH MNGM INV GMBH FOR DEAM-FONDS BBS	CARDARELLI ANGELO	15.900

ent

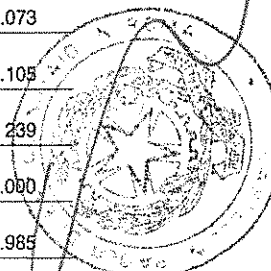

ASSEMBLEA ORDINARIA

31607/1064

12 MAGGIO 2016

Segreteria Societaria - Ufficio Titoli



eni

Unica convocazione

Esito della votazione sul punto 2

Attribuzione dell'utile di esercizio

Elenco Favorevoli

SCHEDA	VPC	NOMINATIVO AZIONISTA	DELEGATO	NUMERO DI AZIONI TOTALE
1176		DEUT ASS & WEALTH MNGM INV GMBH FOR DEAM-FONDS BG 2	CARDARELLI ANGELO	8.000
1183		DEUT ASS & WEALTH MNGM INV GMBH FOR DEAM-FONDS BPT	CARDARELLI ANGELO	209.527
1257		DEUT ASS & WEALTH MNGM INV GMBH FOR DEAM-FONDS BPT	CARDARELLI ANGELO	7.000
1170		DEUT ASS & WEALTH MNGM INV GMBH FOR DEAM-FONDS BW GERMANY	CARDARELLI ANGELO	9.700
1172		DEUT ASS & WEALTH MNGM INV GMBH FOR DEAM-FONDS ENPT	CARDARELLI ANGELO	27.400
1178		DEUT ASS & WEALTH MNGM INV GMBH FOR DEAM-FONDS FBK 1	CARDARELLI ANGELO	8.000
1165		DEUT ASS & WEALTH MNGM INV GMBH FOR DEAM-FONDS FES	CARDARELLI ANGELO	25.000
1254		DEUT ASS & WEALTH MNGM INV GMBH FOR DEAM-FONDS GHS	CARDARELLI ANGELO	50.000
1265		DEUT ASS & WEALTH MNGM INV GMBH FOR DEAM-FONDS GSK 1	CARDARELLI ANGELO	25.500
1181		DEUT ASS & WEALTH MNGM INV GMBH FOR DEAM-FONDS NRRR	CARDARELLI ANGELO	6.800
1264		DEUT ASS & WEALTH MNGM INV GMBH FOR DEAM-FONDS PAL 1	CARDARELLI ANGELO	19.300
1252		DEUT ASS & WEALTH MNGM INV GMBH FOR DEAM-FONDS PG EQ	CARDARELLI ANGELO	99.278
1180		DEUT ASS & WEALTH MNGM INV GMBH FOR DEAM-FONDS PKN 2	CARDARELLI ANGELO	11.700
1253		DEUT ASS & WEALTH MNGM INV GMBH FOR DEAM-FONDS PKN 2	CARDARELLI ANGELO	13.696
1173		DEUT ASS & WEALTH MNGM INV GMBH FOR DEAM-FONDS PPC EQ	CARDARELLI ANGELO	56.171
1166		DEUT ASS & WEALTH MNGM INV GMBH FOR DEAM-FONDS PPC GEQ	CARDARELLI ANGELO	14.629
1169		DEUT ASS & WEALTH MNGM INV GMBH FOR DEAM-FONDS RLG GERMANY	CARDARELLI ANGELO	34.900
1400		DEUT ASS & WEALTH MNGM INV GMBH FOR DWS GLB NAT RES EQ TYP O	CARDARELLI ANGELO	59.297
1397		DEUT ASS & WEALTH MNGM INV GMBH FOR DWS VORSORGE AS (DYNAMIK)	CARDARELLI ANGELO	107.499
1399		DEUT ASS & WEALTH MNGM INV GMBH FOR DWS VORSORGE AS (FLEX)	CARDARELLI ANGELO	44.970
1174		DEUT ASS & WEALTH MNGM INV GMBH FOR GCB PENSION FUND GERMANY	CARDARELLI ANGELO	10.886
1398		DEUT ASS & WEALTH MNGM INV GMBH FOR LOWEN-AKTIEFONDS	CARDARELLI ANGELO	15.000
1402		DEUT ASS & WEALTH MNGM INV GMBH FOR OPPENHEIM GLOBAL STRATEGIE	CARDARELLI ANGELO	9.309

ASSEMBLEA ORDINARIA 12 MAGGIO 2016

Segreteria Societaria - Ufficio Titoli



eni

81607/1065

Handwritten signature

Unica convocazione

Esito della votazione sul punto 2

Attribuzione dell'utile di esercizio

Elenco Favorevoli

SCHEDA	VPC	NOMINATIVO AZIONISTA	DELEGATO	NUMERO DI AZIONI TOTALE
1403		DEUT ASS & WEALTH MNGM INV GMBH FOR SOP EUROLANDWERTE	CARDARELLI ANGELO	65.329
1182		DEUT ASS & WEALTH MNGM INV GMBH FOR STIFTUNGSFONDS SVC 1	CARDARELLI ANGELO	10.268
1406		DEUTSCHE A AND W MANAGEMENT INVESTMENT S.A. FOR DWS ETOILE	CARDARELLI ANGELO	7.500
1175		DEUTSCHE ASSET AND WEALTH MNGM INV GMBH FOR OP-FONDS WFF	CARDARELLI ANGELO	5.173
1179		DEUTSCHE ASSET AND WEALTH MNGM INV GMBH FOR OP-FONDS WFF	CARDARELLI ANGELO	6.471
1405		DEUTSCHE AT AND W MGMT INVEST GMBH FOR MULTI INDEX EQT FD	CARDARELLI ANGELO	14.594
1141		DEUTSCHE BANK-ONSHORE	CARDARELLI ANGELO	6.603
1100		DEUTSCHE EAFE EQUITY INDEX FUND	CARDARELLI ANGELO	11.259
410		DEUTSCHE X-TRACKERS FTSE DEVELOPED EX US COMPREHENSIVE FACTOR ETF	CARDARELLI ANGELO	73
337		DEUTSCHE X-TRACKERS MSCI ALL WORLD EX US HEDGED EQUITY ETF	CARDARELLI ANGELO	10.406
296		DEUTSCHE X-TRACKERS MSCI EAFE HEDGE EQUITY ETF	CARDARELLI ANGELO	2.499.106
363		DEUTSCHE X-TRACKERS MSCI EMU HEDGED EQUITY ETF	CARDARELLI ANGELO	50.110
404		DEUTSCHE X-TRACKERS MSCI ITALY HEDGED EQUITY ETF	CARDARELLI ANGELO	17.213
393		DEUTSCHE X-TRACKERS MSCI SOUTHERN EUROPE HEDGED EQUITY ETF	CARDARELLI ANGELO	7.673
3297		DEXIA PENSION FUND DEXIA ASSET MANAGEMEN	CARDARELLI ANGELO	56.073
1508		DIGNITY HEALTH	CARDARELLI ANGELO	59.547
1509		DIGNITY HEALTH RETIREMENT PLAN TRUST	CARDARELLI ANGELO	56.697
2509		DILL COFONDS	CARDARELLI ANGELO	26.000
529		DIOCESE OF VENICE PENSION PLAN & TRUST	CARDARELLI ANGELO	7.092
2263		DIVERSIFIE ACTIONS 50-65 DU CD	CARDARELLI ANGELO	3.916
1492		DIVERSIFIED INVESTORS PORTFOLIO - INTERNATIONAL EQUITY PTF	CARDARELLI ANGELO	324.215
1303		DIVERSIFIED MARKETS (2010) POOLED FUND TRUST	CARDARELLI ANGELO	22.195
2597		DNCA INVEST	CARDARELLI ANGELO	1.100.000

Handwritten signature

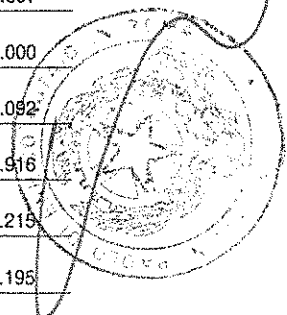

ASSEMBLEA ORDINARIA

81507/1088 12 MAGGIO 2016

Segreteria Societaria - Ufficio Titoli



eni

Unica convocazione

Esito della votazione sul punto 2

Attribuzione dell'utile di esercizio

Elenco Favorevoli

SCHEDA	VPC	NOMINATIVO AZIONISTA	DELEGATO	NUMERO DI AZIONI TOTALE
2598	DNCA INVEST		CARDARELLI ANGELO	1.200.000
3230	DNCA VALUE EUROPE		CARDARELLI ANGELO	1.200.000
1806	DODDINGTON GLOBAL FUND LLC		CARDARELLI ANGELO	392.795
1902	DOMINION RESOURCES INC. MASTER TRUST		CARDARELLI ANGELO	49.000
525	DOMTAR INDUSTRIES INC. MASTER TRUST		CARDARELLI ANGELO	25.000
2996	DPBDIM-Fonds		CARDARELLI ANGELO	9.000
364	DREYFUS INDEX FUNDS INC DREYFUS	INTERNATIONAL STC	CARDARELLI ANGELO	114.542
716	DT INTERNATIONAL STOCK INDEX FUND ONE		CARDARELLI ANGELO	168.289
1784	DUKE ENERGY CORPORATION MASTER RETIREMENT TRUST		CARDARELLI ANGELO	82.180
674	DUKE UNIVERSITY		CARDARELLI ANGELO	73.458
1099	DWS GLOBAL INCOME BUILDER VIP		CARDARELLI ANGELO	234
1840	DYNASTY INVEST, LTD		CARDARELLI ANGELO	3.682
3022	Deka A-Attenburg-Fonds		CARDARELLI ANGELO	5.000
2988	Deka A-DIM-Wetzlar-Fonds		CARDARELLI ANGELO	8.350
1958	EAST BAY MUNICIPAL UTILITY DISTRICT		CARDARELLI ANGELO	82.823
1698	EAST RIDING PENSION FUND		CARDARELLI ANGELO	120.000
1699	EAST RIDING PENSION FUND		CARDARELLI ANGELO	205.949
1735	EATON VANCE (AUSTRALIA) HEXAVEST ALL-COUNTRY GL EQUITY FUND		CARDARELLI ANGELO	6.487
1038	EATON VANCE HEXAVEST GLOBAL EQUITY FUND		CARDARELLI ANGELO	4.029
1039	EATON VANCE HEXAVEST INTERNATIONAL EQUITY FUND		CARDARELLI ANGELO	1.584
53	EATON VANCE INTERNATIONAL (IRELAND)		CARDARELLI ANGELO	647
54	EATON VANCE INTERNATIONAL (IRELAND)		CARDARELLI ANGELO	410
1033	EATON VANCE RICHARD BERNSTEIN ALL ASSET STRATEGY FUND		CARDARELLI ANGELO	77.370

ASSEMBLEA ORDINARIA 12 MAGGIO 2016

Segreteria Societaria - Ufficio Titoli



eni

81607/1064

Handwritten signature

Unica convocazione

Esito della votazione sul punto 2

Attribuzione dell'utile di esercizio

Elenco Favorevoli

SCHEDA	VPC	NOMINATIVO AZIONISTA	DELEGATO	NUMERO DI AZIONI TOTALE
1040		EATON VANCE RICHARD BERNSTEIN EQT STRATEGY FUND	CARDARELLI ANGELO	243.341
200		ECOFI ACTIONS SCR	CARDARELLI ANGELO	14.269
149		ECUREUIL ENERGIE	CARDARELLI ANGELO	177.570
2064		EDINBURGH PARTNERS OPPORTUNITIES FUND PLC	CARDARELLI ANGELO	471.558
2065		EDINBURGH PARTNERS OPPORTUNITIES FUND PLC	CARDARELLI ANGELO	338.732
129		EDMOND DE ROTHSCHILD ASSET MANAGEMENT	CARDARELLI ANGELO	400.000
203		EDMOND DE ROTHSCHILD ASSET MANAGEMENT	CARDARELLI ANGELO	100.000
544		ELECTRICAL WORKERS LOCAL 26 PENSION TRUST FUND	CARDARELLI ANGELO	91.700
413		ELECTRICITY SUPPLY PENSION SCHEME	CARDARELLI ANGELO	39.976
769		ELITE INTER-PHARMCTIONS	CARDARELLI ANGELO	46.206
1956		EMPLOYEES RETIREMENT FUND OF THE CITY OF DALLAS	CARDARELLI ANGELO	4.148
678		EMPLOYEES RETIREMENT SYSTEM OF TEXAS	CARDARELLI ANGELO	370.503
561		EMPLOYEES RETIREMENT SYSTEM OF THE STATE OH HAWAII	CARDARELLI ANGELO	313.537
968		ENERGY INSURANCE MUTUAL LIMITED	CARDARELLI ANGELO	17.445
969		ENERGY INSURANCE MUTUAL LIMITED	CARDARELLI ANGELO	16.932
2630		ENHANCED INDEX INTERNATIONAL SHARE FUND	CARDARELLI ANGELO	343.066
2631		ENHANCED INDEX INTERNATIONAL SHARE FUND	CARDARELLI ANGELO	119.251
2636		ENHANCED INDEX INTERNATIONAL SHARE FUND	CARDARELLI ANGELO	202.562
3093		ENERGY CORP. RETIREMENT PLANS MASTER TR.	CARDARELLI ANGELO	142.968
755		EPARGNE EQUILIBRE FCPE	CARDARELLI ANGELO	11.749
756		EPARGNE PRUDENCE THALES	CARDARELLI ANGELO	27.289
3121		EQ ADV TRUST EQ/INT. EQ. INDEX PORTFOLIO	CARDARELLI ANGELO	717.254
3108		EQ ADVISOR TRUST ATM INTERNATIONAL PORTFOLIO	CARDARELLI ANGELO	227.830

Handwritten signature

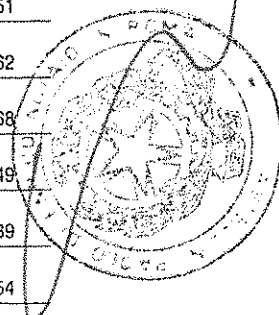

ASSEMBLEA ORDINARIA

81607/1068 12 MAGGIO 2016

Segreteria Societaria - Ufficio Titoli



eni

Unica convocazione

Esito della votazione sul punto 2

Attribuzione dell'utile di esercizio

Elenco Favorevoli

SCHEDA	VPC	NOMINATIVO AZIONISTA	DELEGATO	NUMERO DI AZIONI TOTALE
3100		EQ ADVISORS TRUST - AXA INTERNATIONAL CORE MANAGED VOLATILITY PORTFOLIO	CARDARELLI ANGELO	174.869
3109		EQ ADVISORS TRUST - AXA INTERNATIONAL MANAGED VOLATILITY PORTFOLIO	CARDARELLI ANGELO	94.414
2874		EQ ADVISORS TRUST-AXA GLOBAL EQ MANAGED	CARDARELLI ANGELO	135.204
2888		EQ ADVISORS TRUST-AXA INTL.VALUE MANAGED	CARDARELLI ANGELO	277.410
3110		EQ ADVISORS TRUST-AXA TACTICAL MANAGER I	CARDARELLI ANGELO	351.566
3117		EQ ALLIANCE DYNAMIC WEALTH STRATEGIES PO	CARDARELLI ANGELO	77.905
3104		EQ.ADVISORS TRUST - AXA TEMPLETON GLOBAL	CARDARELLI ANGELO	170.086
3106		EQ.ADVISORS TRUST - AXA TEMPLETON GLOBAL	CARDARELLI ANGELO	31.767
3098		EQ/NATURAL RESOURCES PLUS PORTFOLIO	CARDARELLI ANGELO	23.445
541		EQUITY LEAGUE PENSION TRUST FUND	CARDARELLI ANGELO	128.584
406		ERIE INSURANCE EXCHANGE .	CARDARELLI ANGELO	113.374
1757		ERIKA GLAZER	CARDARELLI ANGELO	11.200
3133		ETFS DIVERSIFIED-FACTOR DEVELOPED EUROPE INDEX FUND	CARDARELLI ANGELO	69
2459		ETHIS VALEURS	CARDARELLI ANGELO	34.410
2277		ETOILE DEVELOPPEMENT DURABLE	CARDARELLI ANGELO	7.424
2264		ETOILE ENERGIE EUROPE	CARDARELLI ANGELO	10.546
2279		ETOILE GESTION	CARDARELLI ANGELO	37.564
2276		ETOILE MATIERES PREMIERES	CARDARELLI ANGELO	13.656
1459		EURO EX-UK ALPHA TITLS FUND B	CARDARELLI ANGELO	100.458
2882		EUROPACIFIC GROWTH FUND	CARDARELLI ANGELO	2.843.000
2409		EUROPEAN EQUITY FUND OF KOKUSAI TRUST INTERTRUST TRUSTEES	CARDARELLI ANGELO	60.136
3166		EUROPEAN STRATEGIC BALANCED FUND	CARDARELLI ANGELO	5.300
1469		EUROPEEX-CONTROVERSIAL WEAPONS EQUITY INDEX FUND B	CARDARELLI ANGELO	475.041

ASSEMBLEA ORDINARIA 12 MAGGIO 2016

Segreteria Societaria - Ufficio Titoli



eni

81607/1069

M. ...

Unica convocazione

Esito della votazione sul punto 2

Attribuzione dell'utile di esercizio

Elenco Favorevoli

SCHEDA VPC	NOMINATIVO AZIONISTA	DELEGATO	NUMERO DI AZIONI TOTALE
533	EVANGELICAL LUTHERAN CHURCH IN AMERICA BOARD OF PENSIONS CARDARELLI ANGELO		59.148
534	EVANGELICAL LUTHERAN CHURCH IN AMERICA BOARD OF PENSIONS CARDARELLI ANGELO		52.633
536	EVANGELICAL LUTHERAN CHURCH IN AMERICA BOARD OF PENSIONS CARDARELLI ANGELO		387.110
537	EVANGELICAL LUTHERAN CHURCH IN AMERICA BOARD OF PENSIONS CARDARELLI ANGELO		18.010
538	EVANGELICAL LUTHERAN CHURCH IN AMERICA BOARD OF PENSIONS CARDARELLI ANGELO		29.238
539	EVANGELICAL LUTHERAN CHURCH IN AMERICA BOARD OF PENSIONS CARDARELLI ANGELO		194.092
540	EVANGELICAL LUTHERAN CHURCH IN AMERICA BOARD OF PENSIONS CARDARELLI ANGELO		21.562
81	EVERKEY GLOBAL FOCUS MASTER LIMITED CO WELLS CAPITAL MGM INC. CARDARELLI ANGELO		13.858
758	EVIAN A EQUILIBRE CARDARELLI ANGELO		6.413
744	EVOLUTIS CARDARELLI ANGELO		296.955
1903	EXELON CORPORATION DEF CONTRIBUTION RET PLANS MASTER TR CARDARELLI ANGELO		57.196
1904	EXELON CORPORATION DEF CONTRIBUTION RET PLANS MASTER TR CARDARELLI ANGELO		115.658
1778	EXELON CORPORATION EMPLOYEES BENEFIT TRUST FOR MNG EMPL CARDARELLI ANGELO		28.850
1779	EXELON CORPORATION NUCLEAR DECOMMISSION TRUST - NON TAX QUAL CARDARELLI ANGELO		1.672
1945	EXELON CORPORATION PENSION MASTER RETIREMENT TRUST CARDARELLI ANGELO		343.299
1946	EXELON CORPORATION PENSION MASTER RETIREMENT TRUST CARDARELLI ANGELO		128.350
1756	EXELON PEACH BOTTOM UNIT 1 QUALIFIED FUND CARDARELLI ANGELO		2.069
2710	FAMEM F CARDARELLI ANGELO		1.889
1679	FAMILY INVESTMENTS CHILD TRUST FUND CARDARELLI ANGELO		66.038
1680	FAMILY INVESTMENTS GLOBAL ICVC FAMILY BALANCED INT FUND CARDARELLI ANGELO		64.414
545	FARMERS GROUP INC.401K SAVINGS PLAN CARDARELLI ANGELO		200.847
785	FC CARPIMKO CARDARELLI ANGELO		52.213
1862	FCM INTERNATIONAL LLC CARDARELLI ANGELO		4.068

M. ...

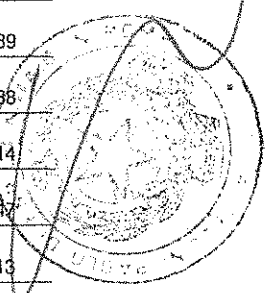

ASSEMBLEA ORDINARIA

81607/1010 12 MAGGIO 2016

Segreteria Societaria - Ufficio Titoli

**eni**

Unica convocazione

Esito della votazione sul punto 2

Attribuzione dell'utile di esercizio**Elenco Favorevoli**

SCHEDA	VPC	NOMINATIVO AZIONISTA	DELEGATO	NUMERO DI AZIONI TOTALE
2703	FCO	THELIA	CARDARELLI ANGELO	1.483
2712	FCP	6347	CARDARELLI ANGELO	3.014
794	FCP	ABP PERP	CARDARELLI ANGELO	32.863
2453	FCP	ACTIONS ISR	CARDARELLI ANGELO	1.544.249
2454	FCP	AG2R LA MONDIALE ACT EUROPE ISR	CARDARELLI ANGELO	289.515
2491	FCP	AIR FRANCE IFC	CARDARELLI ANGELO	11.091
2463	FCP	AIR FRANCE IFC2	CARDARELLI ANGELO	5.592
2441	FCP	ALM REUNICA DIVERSIFIE	CARDARELLI ANGELO	35.600
171	FCP	AMUNDI ACTIONS INTERNATIONALES	CARDARELLI ANGELO	11
177	FCP	AMUNDI ACTIONS RESSOURCES NATURELLES	CARDARELLI ANGELO	3.013
811	FCP	AMUNDI HORIZON	CARDARELLI ANGELO	45.531
175	FCP	AMUNDI INDEX EQUITY GLOBAL LOW CARBON	CARDARELLI ANGELO	18
176	FCP	AMUNDI INDEX EQUITY GLOBAL MULTI SMART ALLOCATION SCIENTIFICBETA	CARDARELLI ANGELO	19
746	FCP	AMUNDI PULSACTIONS	CARDARELLI ANGELO	22.977
135	FCP	AMUNDI RENDEMENT PLUS	CARDARELLI ANGELO	7.387
820	FCP	AMUNDI WORLD DIVERSIFIED FACTOR MIX	CARDARELLI ANGELO	842
2716	FCP	ARPEGE ACTIONS	CARDARELLI ANGELO	15.500
766	FCP	ARRCO LONG TERME C	CARDARELLI ANGELO	101.607
2711	FCP	ASSOC GROUPE SAINT SAUVEUR	CARDARELLI ANGELO	1.827
791	FCP	AVA EUROPE 4 FOND DEDIE'	CARDARELLI ANGELO	72.216
2695	FCP	AVENIR ALIZES	CARDARELLI ANGELO	484
2495	FCP	AXIVA ACTION 1	CARDARELLI ANGELO	14.330
809	FCP	BERRI ACTIONS	CARDARELLI ANGELO	100.482

ASSEMBLEA ORDINARIA 12 MAGGIO 2016

Segreteria Societaria - Ufficio Titoli

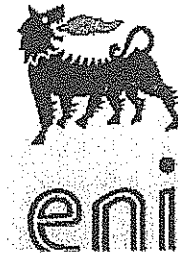

M...

Unica convocazione

Esito della votazione sul punto 2

Attribuzione dell'utile di esercizio

81607/1071

Elenco Favorevoli

SCHEDA	VPC	NOMINATIVO AZIONISTA	DELEGATO	NUMERO DI AZIONI TOTALE
2466	FCP	BNP PARIBAS ACTIONS EUROLAND	CARDARELLI ANGELO	317.550
2467	FCP	BNP PARIBAS ACTIONS EUROPE	CARDARELLI ANGELO	10.909
2449	FCP	BNP PARIBAS BEST SELECTION EURO	CARDARELLI ANGELO	173.630
2476	FCP	BNPP ACTIONS EUROLAND	CARDARELLI ANGELO	851.872
771	FCP	BOURBON 1	CARDARELLI ANGELO	70.000
772	FCP	BOURBON 3	CARDARELLI ANGELO	35.666
774	FCP	BOURBON 4	CARDARELLI ANGELO	19.895
3227	FCP	BRONGNIART RENDEMENT	CARDARELLI ANGELO	250.000
2475	FCP	CALCIUM QUANT	CARDARELLI ANGELO	41.809
2480	FCP	CAMGEST VALEURS EURO	CARDARELLI ANGELO	269.714
2645	FCP	CAPSUGEL	CARDARELLI ANGELO	3.000
210	FCP	CARPIMKO EUROPE	CARDARELLI ANGELO	121.242
2644	FCP	CIC ACTIONS 60	CARDARELLI ANGELO	2.983
3223	FCP	CM ACTIONS EURO	CARDARELLI ANGELO	257.863
2696	FCP	CM FRANCE ACTIONS	CARDARELLI ANGELO	536.692
792	FCP	CNP GGR	CARDARELLI ANGELO	9.948
155	FCP	COLOMBES 6	CARDARELLI ANGELO	62.468
161	FCP	COLOMBES 6 BIS	CARDARELLI ANGELO	100.000
2709	FCP	CONGREGATION DES SOEURS DE LA CROIX	CARDARELLI ANGELO	1.244
152	FCP	CPR ACTIVE EUROPE	CARDARELLI ANGELO	27.138
143	FCP	CPR CONSOMMATEUR ACTIONNAIRE	CARDARELLI ANGELO	13.847
777	FCP	CRN SOGE ACTIONS	CARDARELLI ANGELO	135.536
2683	FCP	CRYOSTAR FRANCE	CARDARELLI ANGELO	540

S...

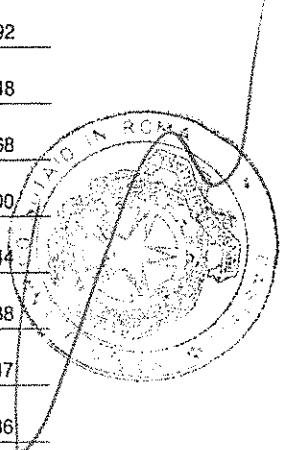

ASSEMBLEA ORDINARIA

81607/1072 12 MAGGIO 2016

Segreteria Societaria - Ufficio Titoli



eni

Unica convocazione

Esito della votazione sul punto 2

Attribuzione dell'utile di esercizio

Elenco Favorevoli

SCHEDA	VPC	NOMINATIVO AZIONISTA	DELEGATO	NUMERO DI AZIONI TOTALE
803		FCP CURIE INVESTISSEMENTS	CARDARELLI ANGELO	30.000
2682		FCP DEGUSSA DYNAMIQUE	CARDARELLI ANGELO	1.280
2681		FCP DEGUSSA MIXTE	CARDARELLI ANGELO	390
2484		FCP DIVERS D&O CAMGEST	CARDARELLI ANGELO	49.000
790		FCP ECUREUIL PROFIL 90	CARDARELLI ANGELO	334.765
178		FCP ECUREUIL RETRAITE EURO ACTIONS 4	CARDARELLI ANGELO	90.000
2715		FCP EPTA	CARDARELLI ANGELO	1.851
211		FCP ERISA DIVERSIFIE 2	CARDARELLI ANGELO	43.657
2692		FCP ES GESTION EQUILIBRE	CARDARELLI ANGELO	124.430
2693		FCP ES TEMPERE	CARDARELLI ANGELO	21.000
2679		FCP ESSO DIVERSIFIE	CARDARELLI ANGELO	40.000
2452		FCP EURO ETHIQUE INSTITUTIONS	CARDARELLI ANGELO	165.000
2678		FCP EUROP ASSISTANCE DIVERSIFIE	CARDARELLI ANGELO	1.480
2680		FCP EUROP ASSISTANCE DIVERSIFIE	CARDARELLI ANGELO	2.000
2714		FCP FAMILLE GOETSCHY	CARDARELLI ANGELO	387
773		FCP FDRN AMUNDI	CARDARELLI ANGELO	50.166
2469		FCP FEDERIS ACTION	CARDARELLI ANGELO	121.948
2462		FCP FEDERIS EURO ACTIONS	CARDARELLI ANGELO	159.100
2458		FCP FEDERIS IRC ACTIONS	CARDARELLI ANGELO	113.920
2442		FCP FEDERIS MM EURO ACTIONS	CARDARELLI ANGELO	4.540
2451		FCP FEDERIS PRO ACTIONS ISR EURO	CARDARELLI ANGELO	72.455
2470		FCP FIMA FRANCE PME	CARDARELLI ANGELO	25.436
775		FCP FMS 3	CARDARELLI ANGELO	67.180

ASSEMBLEA ORDINARIA 12 MAGGIO 2016

Segreteria Societaria - Ufficio Titoli

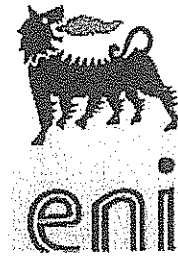

Mancini

81607/1013

Unica convocazione

Esito della votazione sul punto 2

Attribuzione dell'utile di esercizio

Elenco Favorevoli

SCHEDA	VPC	NOMINATIVO AZIONISTA	DELEGATO	NUMERO DI AZIONI TOTALE
2691	FCP	GAILLON 130/30	CARDARELLI ANGELO	12.858
3229	FCP	GAILLON MAITRE ACTIONS	CARDARELLI ANGELO	9.004
3220	FCP	GAILLON NATURAL RESOURCES	CARDARELLI ANGELO	6.600
3222	FCP	GAILLON RENDEMENT	CARDARELLI ANGELO	111.215
2483	FCP	GERISO	CARDARELLI ANGELO	8.847
2675	FCP	GESTION PLACEMENT 1	CARDARELLI ANGELO	1.319
2671	FCP	GROUPE FORD FRANCE	CARDARELLI ANGELO	7.810
2670	FCP	GROUPE ROCHE	CARDARELLI ANGELO	14.200
2669	FCP	GUTENBERG	CARDARELLI ANGELO	3.942
752	FCP	HAMELIN DIVERSIFIE FLEX I	CARDARELLI ANGELO	30.000
205	FCP	HAMELIN DIVERSIFIE FLEX II	CARDARELLI ANGELO	9.323
2668	FCP	HENKEL DIVERSIFIE N 1	CARDARELLI ANGELO	900
2438	FCP	HORIZONS LMG	CARDARELLI ANGELO	33.850
2446	FCP	HP ACTIONS LAZARD	CARDARELLI ANGELO	235.150
212	FCP	HSBC ACTIONS FRANCE	CARDARELLI ANGELO	208.000
802	FCP	ICARE	CARDARELLI ANGELO	16
2646	FCP	JET SERVICES 0291	CARDARELLI ANGELO	8.425
2486	FCP	KLESIA A DIVERSIFIE	CARDARELLI ANGELO	90.000
2666	FCP	LUCKY	CARDARELLI ANGELO	1.626
2665	FCP	METSO MINERALS	CARDARELLI ANGELO	2.815
2664	FCP	MGE DYNAMIQUE EURO	CARDARELLI ANGELO	7.400
789	FCP	NATIXIS IONIS	CARDARELLI ANGELO	18.860
2468	FCP	NF GALILEE	CARDARELLI ANGELO	64.370

Mancini

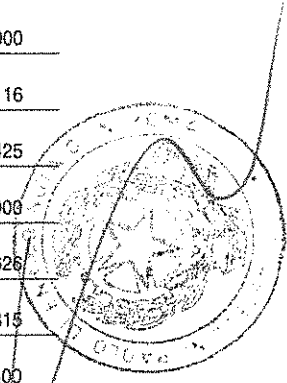

ASSEMBLEA ORDINARIA

81607/2016 12 MAGGIO 2016

Segreteria Societaria - Ufficio Titoli



eni

Unica convocazione

Esito della votazione sul punto 2

Attribuzione dell'utile di esercizio

Elenco Favorevoli

SCHEDA	VPC	NOMINATIVO AZIONISTA	DELEGATO	NUMERO DI AZIONI TOTALE
2706	FCP OFFENSIF AIR LIQUIDE EXPANS		CARDARELLI ANGELO	13.140
2663	FCP PATRIMOINE PLACEMENT 2		CARDARELLI ANGELO	1.127
2662	FCP PATRIMOINE PLACEMENT 3		CARDARELLI ANGELO	2.791
2661	FCP PATRIMOINE PLACEMENT 5		CARDARELLI ANGELO	1.792
209	FCP PHARMA PARFRANCE		CARDARELLI ANGELO	199.722
821	FCP PORTFOLIO LCR ACTIONS		CARDARELLI ANGELO	57.767
2718	FCP PRIEURE MARQUET		CARDARELLI ANGELO	1.500
2713	FCP PYRENEES GLOBAL		CARDARELLI ANGELO	4.312
2447	FCP REUNICA FORTIS		CARDARELLI ANGELO	149.380
798	FCP RL PREVOYANCE		CARDARELLI ANGELO	40.616
751	FCP RSI EURO P		CARDARELLI ANGELO	92.236
800	FCP RSI EURO P		CARDARELLI ANGELO	239.965
796	FCP RSRC DIVERSIFIE		CARDARELLI ANGELO	145.888
2705	FCP SAINT ARBOGAST		CARDARELLI ANGELO	1.428
2445	FCP SAINT MARTIN 3		CARDARELLI ANGELO	173.050
2497	FCP SAINT MARTIN 4		CARDARELLI ANGELO	240.000
2444	FCP SAINT MARTIN N1		CARDARELLI ANGELO	120.347
2440	FCP SAKKARAH 2		CARDARELLI ANGELO	30.500
2450	FCP SAKKARAH 5		CARDARELLI ANGELO	52.000
3207	FCP SAKKARAH 6		CARDARELLI ANGELO	50.000
2496	FCP SAKKARAH 7		CARDARELLI ANGELO	62.358
2701	FCP SCORE 2012		CARDARELLI ANGELO	1.036
2685	FCP SCORE 620		CARDARELLI ANGELO	3.000

ASSEMBLEA ORDINARIA 12 MAGGIO 2016

Segreteria Societaria - Ufficio Titoli



eni

81607/1075

M. M.

Unica convocazione

Esito della votazione sul punto 2

Attribuzione dell'utile di esercizio

Elenco Favorevoli

SCHEDA	VPC	NOMINATIVO AZIONISTA	DELEGATO	NUMERO DI AZIONI TOTALE
2659	FCP SCORE AD	BESANCON	CARDARELLI ANGELO	1.889
2658	FCP SCORE AUMEX		CARDARELLI ANGELO	3.602
2657	FCP SCORE GALIEN		CARDARELLI ANGELO	5.399
2717	FCP SCORE M A R S		CARDARELLI ANGELO	316
2656	FCP SCORE M O		CARDARELLI ANGELO	1.354
2704	FCP SCORE MARIE JOSEPH		CARDARELLI ANGELO	5.182
2655	FCP SCORE ORMESSON		CARDARELLI ANGELO	3.012
2654	FCP SCORE PILLAUD		CARDARELLI ANGELO	1.910
2651	FCP SCORE SAINT JOSEPH		CARDARELLI ANGELO	1.816
2652	FCP SCORE SAINTE URSULE		CARDARELLI ANGELO	2.973
2700	FCP SCORE SAXE		CARDARELLI ANGELO	8.092
2699	FCP SCORE SIGMA		CARDARELLI ANGELO	6.952
2650	FCP SCORE THANRY		CARDARELLI ANGELO	1.307
779	FCP TONI ACTIONS 100		CARDARELLI ANGELO	21.368
3228	FCP TRANSAT PATRIMOINE 2		CARDARELLI ANGELO	140.000
2687	FCP TROUVU		CARDARELLI ANGELO	915
154	FCP UBAM ACTIONS EURO RENDEMENT		CARDARELLI ANGELO	217.459
2474	FCP UBS F EURO OPPORT UNCON PEA EUR		CARDARELLI ANGELO	34.443
3225	FCP UNION EUROPE		CARDARELLI ANGELO	259.076
3224	FCP UNION FRANCE		CARDARELLI ANGELO	42.886
3221	FCP UNION LONG SHORT EUROPE		CARDARELLI ANGELO	16.399
793	FCP VILLIERS ALLEGRO		CARDARELLI ANGELO	305.438
780	FCP VIVACCIO ACTIONS		CARDARELLI ANGELO	158.400

am

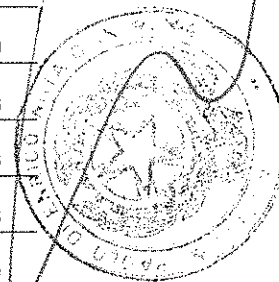

ASSEMBLEA ORDINARIA

81607/2016 12 MAGGIO 2016

Segreteria Societaria - Ufficio Titoli



eni

Unica convocazione

Esito della votazione sul punto 2

Attribuzione dell'utile di esercizio

Elenco Favorevoli

SCHEDA	VPC	NOMINATIVO AZIONISTA	DELEGATO	NUMERO DI AZIONI TOTALE
2698	FCPE	ACCOR DIVERSIFIE	CARDARELLI ANGELO	6.660
763	FCPE	AMUNDI LABEL DYNAMIQUE	CARDARELLI ANGELO	16
757	FCPE	AMUNDI LABEL EQUILIBRE	CARDARELLI ANGELO	16
762	FCPE	AMUNDI LABEL PRUDENCE	CARDARELLI ANGELO	14
153	FCPE	AMUNDI PREM PATRIMOINE	CARDARELLI ANGELO	33
141	FCPE	AMUNDI RESA ACTIONS EUROPE	CARDARELLI ANGELO	17
144	FCPE	AMUNDI RESA ESG ACTIONS EURO	CARDARELLI ANGELO	477
2640	FCPE	AREVA ACTIONS	CARDARELLI ANGELO	34.827
2488	FCPE	AXA GENERATION EUROPE ACTIONS	CARDARELLI ANGELO	269.000
2689	FCPE	BARCLAYS DIVERIFIE ACTIONS	CARDARELLI ANGELO	10.000
2686	FCPE	COFACE	CARDARELLI ANGELO	4.000
2708	FCPE	CONVERGENCE ACTIONS EUROPE	CARDARELLI ANGELO	33.000
2690	FCPE	CONVERGENCE DIVERSIFIE	CARDARELLI ANGELO	90.500
2707	FCPE	FONCIL	CARDARELLI ANGELO	12.000
2464	FCPE	GPE FMC FCE DIV BNP	CARDARELLI ANGELO	2.612
2482	FCPE	HORIZON EP. ACTION	CARDARELLI ANGELO	14.000
742	FCPE	JUNON ACTIONS OBLIGATIONS	CARDARELLI ANGELO	103.105
2465	FCPE	LIMACTIF	CARDARELLI ANGELO	3.024
801	FCPE	NATIXIS ES ACTIONS EURO	CARDARELLI ANGELO	60.550
2660	FCPE	PIPE LINE SUD EUROPEEN	CARDARELLI ANGELO	2.500
202	FCPE	SAIPEM ACTIONS	CARDARELLI ANGELO	6.000
806	FCPE	TECHNIP DYNAMIQUE	CARDARELLI ANGELO	10.458
807	FCPE	TECHNIP EQUILIBRE	CARDARELLI ANGELO	12.080

ASSEMBLEA ORDINARIA 12 MAGGIO 2016

Segreteria Societaria - Ufficio Titoli



eni

81607/1077

M. Scari

Unica convocazione

Esito della votazione sul punto 2

Attribuzione dell'utile di esercizio

Elenco Favorevoli

SCHEDA	VPC	NOMINATIVO AZIONISTA	DELEGATO	NUMERO DI AZIONI TOTALE
2647	FCPE THALES AVIONICS		CARDARELLI ANGELO	4.040
2493	FCPE TOTAL ACTIONS EUROPEENNES		CARDARELLI ANGELO	450.000
2254	FCPE TOTAL DIV A DOM ACTIONS		CARDARELLI ANGELO	112.358
2688	FCP_CAGNI		CARDARELLI ANGELO	7.800
159	FDC A2		CARDARELLI ANGELO	207.521
166	FDC A6 POCHE TITRES		CARDARELLI ANGELO	72.700
2262	FDJ ACTIONS EURO		CARDARELLI ANGELO	21.431
1221	FEDERATED CITY EMPLOYEES RETIREMENT SYSTEM		CARDARELLI ANGELO	47.752
2477	FEDERIS AVENIR EURO-PE		CARDARELLI ANGELO	27.700
2457	FEDERIS EPARGNE EQUILIBREE		CARDARELLI ANGELO	7.080
1032	FEDEX CORPORATION EMPLOYEES PENSION TRUST		CARDARELLI ANGELO	37.736
1878	FIDELITY ADVISOR SERIES VIII FIDELITY ADVISOR OVERSEAS FUND		CARDARELLI ANGELO	60.300
354	FIDELITY CONCORD STREET TRUST SPARTAN INTERNATIONAL INDEX FUND		CARDARELLI ANGELO	3.045.285
2361	FIDELITY CONTRAFUND		CARDARELLI ANGELO	716.400
2422	FIDELITY CONTRAFUND FID ADVISOR NEW INSI		CARDARELLI ANGELO	101.500
2377	FIDELITY FUNDS SICAV		CARDARELLI ANGELO	6.236.667
2378	FIDELITY FUNDS SICAV		CARDARELLI ANGELO	278.354
2406	FIDELITY GROUP TRUST FOR EMPLOYEE BENEFIT		CARDARELLI ANGELO	800.000
1877	FIDELITY HASTINGS STREET TRUST: FIDELITY FUND		CARDARELLI ANGELO	273.600
3086	FIDELITY INVESTMENT FUNDS - FIDELIT		CARDARELLI ANGELO	98.965
3087	FIDELITY INVESTMENT FUNDS - FIDELITY MONEYBUILDER WORLD INDEX FUND		CARDARELLI ANGELO	30.122
881	FIDELITY INVESTMENT TRUST: FIDELITY GLOBAL COMMODITY STOCK F		CARDARELLI ANGELO	58.000
882	FIDELITY INVESTMENT TRUST: FIDELITY SERIES INTVALUE FUND		CARDARELLI ANGELO	10.159.700

M. Scari

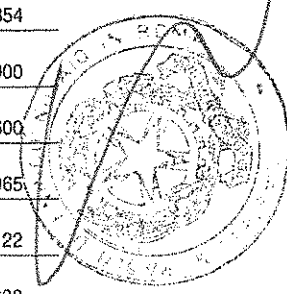

ASSEMBLEA ORDINARIA

81607/1078 12 MAGGIO 2016

Segreteria Societaria - Ufficio Titoli



eni

Unica convocazione

Esito della votazione sul punto 2

Attribuzione dell'utile di esercizio

Elenco Favorevoli

SCHEDA	VPC	NOMINATIVO AZIONISTA	DELEGATO	NUMERO DI AZIONI TOTALE
879		FIDELITY INVESTMENT TRUST: FIDELITY TOTAL INT EQUITY FUND	CARDARELLI ANGELO	94.900
3125		FIDELITY INVESTMENTS MONEY MANAGEMENT INC	CARDARELLI ANGELO	270
3139		FIDELITY INVESTMENTS MONEY MANAGEMENT INC	CARDARELLI ANGELO	1.021
3140		FIDELITY INVESTMENTS MONEY MANAGEMENT INC	CARDARELLI ANGELO	300
1027		FIDELITY NORTHSTAR FUND	CARDARELLI ANGELO	2.200.000
2401		FIDELITY PURITAN TF LOW PRICE STOCK FUND	CARDARELLI ANGELO	8.000.000
880		FIDELITY RUTLAND SQUARE TR II: STRAT ADV INT MULTI-MANAGER F	CARDARELLI ANGELO	7.009
883		FIDELITY RUTLAND SQUARETRUST II: STRATEGIC ADVISERS INT F	CARDARELLI ANGELO	788.772
884		FIDELITY RUTLAND SQUARETRUST II: STRATEGIC ADVISERS INT F	CARDARELLI ANGELO	546.600
885		FIDELITY RUTLAND SQUARETRUST II: STRATEGIC ADVISERS INT F	CARDARELLI ANGELO	115.304
2397		FIDELITY SAL ST SPARTAN GLOBAL EX US IN	CARDARELLI ANGELO	194.880
1879		FIDELITY SALEM STREET TRUST FIDELITY SERIES GLOBAL EX U.S. INDEX FUND	CARDARELLI ANGELO	476.988
417		FIDELITY SALEM STREET TRUST FIDELITY SAI INTERNATIONAL INDEXFUND	CARDARELLI ANGELO	106.892
3233		FIDUCIARY TRUST COMPANY INTERNATIONAL AS	CARDARELLI ANGELO	25.567
736		FIRE AND POLICE PENSION ASSOCIATION OF COLOR	CARDARELLI ANGELO	39.527
737		FIRE AND POLICE PENSION ASSOCIATION OF COLOR	CARDARELLI ANGELO	2.576
1960		FIREMEN'S ANNUITY & BENEFIT FUND OF CHICAGO	CARDARELLI ANGELO	106.700
2800		FIRST CLEARING LLC	CARDARELLI ANGELO	20.158
2280		FIRST EAGLE AMUNDI INCOME BUIL	CARDARELLI ANGELO	21.348
1196		FIRST EAGLE GLOBAL INCOME BUILDER FUND	CARDARELLI ANGELO	53.369
1703		FIRST STATE INVESTMENTS ICVC-FIRST STATE DIVERSIFIED GROWTH F	CARDARELLI ANGELO	770
455		FIRST TRUST ISE GLOBAL COPPER INDEX FUND	CARDARELLI ANGELO	73.881
2424		FIRST TRUST RIVERFRONT DYN DEV INT ETF	CARDARELLI ANGELO	3.490

ASSEMBLEA ORDINARIA 12 MAGGIO 2016

Segreteria Societaria - Ufficio Titoli



eni

81607/1019

Handwritten signature

Unica convocazione

Esito della votazione sul punto 2

Attribuzione dell'utile di esercizio

Elenco Favorevoli

SCHEDA VPC	NOMINATIVO AZIONISTA	DELEGATO	NUMERO DI AZIONI TOTALE
2423	FIRST TRUST RIVERFRONT DYNAMIC EUROPE ET	CARDARELLI ANGELO	4.670
1364	FLEXIBLE PORTFOLIO	CARDARELLI ANGELO	50.000
2950	FLEXSHARES INTERNATIONAL QUALITY DIVIDEND DEFENSIVE INDEX FUND	CARDARELLI ANGELO	41.600
2951	FLEXSHARES INTERNATIONAL QUALITY DIVIDEND INDEX FUND	CARDARELLI ANGELO	21.444
2952	FLEXSHARES INTERNATIONAL QUALITY DIVIDEND INDEX FUND	CARDARELLI ANGELO	266.490
2935	FLEXSHARES MORNINGSTAR DEVELOPED MARKETS EX-US FACTOR TILT INDEX FUND	CARDARELLI ANGELO	46.939
2941	FLEXSHARES MORNINGSTAR GLOBAL UPSTREAM N	CARDARELLI ANGELO	994.042
3178	FLF EUROPE EQUITY EX UK FUND	CARDARELLI ANGELO	1.747.725
3173	FLF STRATEGIC GLOBAL EQUITY FUND	CARDARELLI ANGELO	74.987
546	FLORIDA BIRTH-RELATED NEUROLOGICAL INJURY COMPENSATION ASSOCIATION	CARDARELLI ANGELO	46.213
1758	FLORIDA COLLEGE SAVINGS PROGRAM	CARDARELLI ANGELO	4.863
739	FLORIDA GLOBAL EQUITY FUND LLC	CARDARELLI ANGELO	27.168
1961	FLORIDA PREPAID COLLEGE PROGRAM	CARDARELLI ANGELO	30.230
547	FLORIDA RETIREMENT SYSTEM .	CARDARELLI ANGELO	49.776
548	FLORIDA RETIREMENT SYSTEM .	CARDARELLI ANGELO	120.264
549	FLORIDA RETIREMENT SYSTEM .	CARDARELLI ANGELO	1.404.621
550	FLORIDA RETIREMENT SYSTEM .	CARDARELLI ANGELO	393.626
551	FLORIDA RETIREMENT SYSTEM .	CARDARELLI ANGELO	1.109.358
497	FLORIDA STATE BOARD OF ADMINISTRATION	CARDARELLI ANGELO	24.470
1193	FLOURISH INVESTMENT CORPORATION	CARDARELLI ANGELO	882.412
1194	FLOURISH INVESTMENT CORPORATION	CARDARELLI ANGELO	116.015
1195	FLOURISH INVESTMENT CORPORATION	CARDARELLI ANGELO	135.743
1198	FLOURISH INVESTMENT CORPORATION	CARDARELLI ANGELO	1.503.023

Handwritten signature

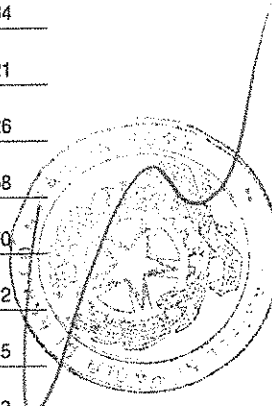

ASSEMBLEA ORDINARIA

81607/080 12 MAGGIO 2016

Segreteria Societaria - Ufficio Titoli



eni

Unica convocazione

Esito della votazione sul punto 2

Attribuzione dell'utile di esercizio

Elenco Favorevoli

SCHEDA	VPC	NOMINATIVO AZIONISTA	DELEGATO	NUMERO DI AZIONI TOTALE
1199		FLOURISH INVESTMENT CORPORATION	CARDARELLI ANGELO	1.432.318
1204		FLOURISH INVESTMENT CORPORATION	CARDARELLI ANGELO	1.427.042
92		FOCUSED SICAV GLOBAL EQUITY STRATEGY (USD)	CARDARELLI ANGELO	13.246
3279		FOLKSAM OMESESIDIG LIVFORSAKRING	CARDARELLI ANGELO	130.570
3285		FOLKSAM OMESESIDIG LIVFORSAKRING	CARDARELLI ANGELO	153.278
3284		FOLKSAM OMESESIDIG SAKFORSAKRING	CARDARELLI ANGELO	14.868
123		FONDACO ROMA EURO BALANCED CORE	CARDARELLI ANGELO	18.765
122		FONDACO ROMA GLOBAL EQUITY SATELLITE II	CARDARELLI ANGELO	96.675
3164		FONDATION J.ARMAND BOMBARDIER	CARDARELLI ANGELO	8.613
2558		FONDS ASSECURA I	CARDARELLI ANGELO	2.063
3250		FONDS DE SOLIDARITE DES TRAV.QUEBEC FTQ	CARDARELLI ANGELO	65.959
3251		FONDS DE SOLIDARITE DES TRAV.QUEBEC FTQ	CARDARELLI ANGELO	65.849
1007		FONDS DGIA ACTIONS MONDIALES GRANDE CAPITALISATION	CARDARELLI ANGELO	29.741
1006		FONDS PRIVE GPD ACTIONS INTERNATIONALES	CARDARELLI ANGELO	50.000
2501		FONDS RESERVE RETRAITES	CARDARELLI ANGELO	355.340
1833		FOOD & AGRICULTURE ORGANISATION OF THE UNITED NATIONS.	CARDARELLI ANGELO	14.214
1905		FORD MOTOR COMPANY DEFINED BENEFIT MASTER TRUST	CARDARELLI ANGELO	42.672
1906		FORD MOTOR COMPANY DEFINED BENEFIT MASTER TRUST	CARDARELLI ANGELO	45.314
1989		FORD MOTOR COMPANY OF CANADA, LIMITED PENSION TRUST	CARDARELLI ANGELO	18.051
3036		FOREIGN AND COLONIAL INVESTMENT TRUST PL	CARDARELLI ANGELO	363.102
3283		FORENADE LIV GRUPPOFORSAKRING AB (PUBL)	CARDARELLI ANGELO	2.443
2694		FRANCE ACTION 250	CARDARELLI ANGELO	11.311
1029		FRANCISCAN ALLIANCE, INC.	CARDARELLI ANGELO	136.578

ASSEMBLEA ORDINARIA 12 MAGGIO 2016

Segreteria Societaria - Ufficio Titoli



eni

81607/1081

[Handwritten signature]

Unica convocazione

Esito della votazione sul punto 2

Attribuzione dell'utile di esercizio

Elenco Favorevoli

SCHEDA	VPC	NOMINATIVO AZIONISTA	DELEGATO	NUMERO DI AZIONI TOTALE
451		FRANCISCAN ALLIANCE, INC. MASTER PENSION TRUST	CARDARELLI ANGELO	87.420
2926		FRANKLIN T.VARIABLE INSURANCE PRODUCTS T	CARDARELLI ANGELO	776.759
2747		FRANKLIN TEMPLETON INVESTMENT FUNDS	CARDARELLI ANGELO	506.632
2748		FRANKLIN TEMPLETON INVESTMENT FUNDS	CARDARELLI ANGELO	305.700
2749		FRANKLIN TEMPLETON INVESTMENT FUNDS	CARDARELLI ANGELO	362.081
2750		FRANKLIN TEMPLETON INVESTMENT FUNDS	CARDARELLI ANGELO	842.075
2751		FRANKLIN TEMPLETON INVESTMENT FUNDS	CARDARELLI ANGELO	18.879
2752		FRANKLIN TEMPLETON INVESTMENT FUNDS	CARDARELLI ANGELO	4.255.215
2753		FRANKLIN TEMPLETON INVESTMENT FUNDS	CARDARELLI ANGELO	320.266
2754		FRANKLIN TEMPLETON INVESTMENT FUNDS	CARDARELLI ANGELO	191.198
2755		FRANKLIN TEMPLETON INVESTMENT FUNDS	CARDARELLI ANGELO	1.138.529
2767		FRANKLIN TEMPLETON INVESTMENT FUNDS	CARDARELLI ANGELO	17.893
2775		FRANKLIN TEMPLETON INVESTMENT FUNDS	CARDARELLI ANGELO	436.158
240		FRANKLIN TEMPLETON INVESTMENTS	CARDARELLI ANGELO	206.258
3195		FRANKLIN TEMPLETON SHARIAH FUNDS 8A	CARDARELLI ANGELO	56.528
358		FRANKLIN TEMPLETON SINOAM GLOBAL GROWTH FUND	CARDARELLI ANGELO	44.315
2939		FRANKLIN TEMPLETON VARIAB. INSURANCE	CARDARELLI ANGELO	1.349.435
1691		FRIENDS LIFE LIMITED	CARDARELLI ANGELO	161.227
1692		FRIENDS LIFE LIMITED	CARDARELLI ANGELO	33.986
1693		FRIENDS LIFE LIMITED	CARDARELLI ANGELO	3.204
1694		FRIENDS LIFE LIMITED	CARDARELLI ANGELO	5.799
1695		FRIENDS LIFE LIMITED	CARDARELLI ANGELO	5.094
1696		FRIENDS LIFE LIMITED	CARDARELLI ANGELO	3.558

[Handwritten signature]

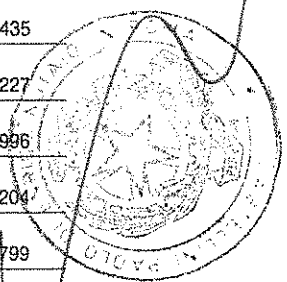

ASSEMBLEA ORDINARIA

81607/1082 12 MAGGIO 2016

Segreteria Societaria - Ufficio Titoli



eni

Unica convocazione

Esito della votazione sul punto 2

Attribuzione dell'utile di esercizio

Elenco Favorevoli

SCHEDA	VPC	NOMINATIVO AZIONISTA	DELEGATO	NUMERO DI AZIONI TOTALE
1697		FRIENDS LIFE LIMITED	CARDARELLI ANGELO	3.136
552		FRONTIERS INTERNATIONAL EQUITY POOL	CARDARELLI ANGELO	19.950
2502		FRR	CARDARELLI ANGELO	429.336
2834		FSS TRUSTEE CORPORATION	CARDARELLI ANGELO	44.091
2837		FSS TRUSTEE CORPORATION	CARDARELLI ANGELO	333.078
266		FT DOW JONES GLOBAL SELECT DIVIDEND INDEXFUND	CARDARELLI ANGELO	241.471
3170		FTSE ALL WORLD INDEX FUND	CARDARELLI ANGELO	165.995
2945		FUNDACAO CALOUSTE GULBENKIAN	CARDARELLI ANGELO	65.355
1807		FUNDO DE PENSOES	CARDARELLI ANGELO	72.827
1996		FUTURE FUND BOARD OF GUARDIANS FOR AND ON BEHALF OF FUTURE F	CARDARELLI ANGELO	145.672
3175		Friends Life Limited	CARDARELLI ANGELO	678.468
3176		Friends Life Limited	CARDARELLI ANGELO	73.252
3177		Friends Life Limited	CARDARELLI ANGELO	7.476
3256		Friends Life Limited	CARDARELLI ANGELO	12.612
146		G FINANCIER AMUNDI	CARDARELLI ANGELO	18
2599		GA FUND L	CARDARELLI ANGELO	5.037
1041		GABELLI EQUITY INCOME FUND	CARDARELLI ANGELO	29.000
2855		GAMMA EMIRATES INVESTMENT L.L.C. EM	CARDARELLI ANGELO	6.821
2000		GARD COMMON CONTRACTUAL FUND	CARDARELLI ANGELO	33.150
1606		GE INVESTMENTS FUNDS, INC. - TOTAL RETURN FUND	CARDARELLI ANGELO	86.297
982		GENERAL CONFERENCE CORPORATION OF SEVENTH DAY ADVENTISTS	CARDARELLI ANGELO	9.360
1505		GENERAL CONFERENCE CORPORATION OF SEVENTH DAY ADVENTISTS	CARDARELLI ANGELO	93.539
1043		GENERAL ELECTRIC PENSION TRUST	CARDARELLI ANGELO	18.655

ASSEMBLEA ORDINARIA 12 MAGGIO 2016

Segreteria Societaria - Ufficio Titoli



eni

81607/1083

Man

Unica convocazione

Esito della votazione sul punto 2

Attribuzione dell'utile di esercizio

Elenco Favorevoli

SCHEDA VPC	NOMINATIVO AZIONISTA	DELEGATO	NUMERO DI AZIONI TOTALE
1044	GENERAL ELECTRIC PENSION TRUST	CARDARELLI ANGELO	288.925
1964	GENERAL PENSION AND SOCIAL SECURITY AUTHORITY	CARDARELLI ANGELO	75.814
1965	GENERAL PENSION AND SOCIAL SECURITY AUTHORITY	CARDARELLI ANGELO	96.840
855	GEORGES R. HAIRK PARAMETRICO PORTFOLIO ASSOCIATES	CARDARELLI ANGELO	1.222
1190	GEUT PAN EUROPEAN EQUITY INDEX FUND	CARDARELLI ANGELO	149.433
2736	GIVI GLOBAL EQUITY FUND CLT AC	CARDARELLI ANGELO	42.517
657	GLAXOSMITHKLINE MASTER RETIREMENT TRUST	CARDARELLI ANGELO	155.004
405	GLG INVESTMENTS PLC	CARDARELLI ANGELO	24.420
1344	GLOBAL ADVANTAGE FUNDS - MAJOR MARKETS TEILFONDS	CARDARELLI ANGELO	180.467
1464	GLOBAL ALPHA TILTS FUND B	CARDARELLI ANGELO	5.446
604	GLOBAL DIVIDEND CLASS (SETANTA)	CARDARELLI ANGELO	364.258
606	GLOBAL EQUITY CLASS (SETANTA)	CARDARELLI ANGELO	24.197
1471	GLOBAL EX US ALPHA TILTS FUND B	CARDARELLI ANGELO	47.005
2243	GLOBAL HIGH INCOME EQUITY	CARDARELLI ANGELO	41.150
1456	GLOBAL MULTI-CAP EQUITY FUND B	CARDARELLI ANGELO	12.550
2420	GLOBAL X SCIENTIFIC BETA EUROPE ETF	CARDARELLI ANGELO	1.146
946	GMAM INVESTMENT FUNDS TRUST	CARDARELLI ANGELO	85.987
947	GMAM INVESTMENT FUNDS TRUST	CARDARELLI ANGELO	225.355
1081	GMO AGGRESSIVE LONG/SHORT MASTER PORTFOLIO	CARDARELLI ANGELO	70.430
2364	GMO Alpha Only Fund	CARDARELLI ANGELO	15.797
1079	GMO BENCHMARK-FREE FUND	CARDARELLI ANGELO	242.089
2370	GMO DEVELOPED WORLD STOCK FUND	CARDARELLI ANGELO	93.337
2363	GMO ERISA POOL	CARDARELLI ANGELO	383.021

Man

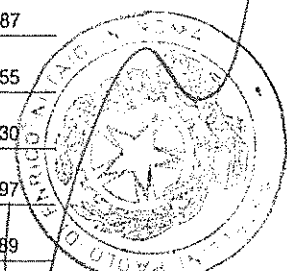

ASSEMBLEA ORDINARIA

81607/1084 12 MAGGIO 2016

Segreteria Societaria - Ufficio Titoli



eni

Unica convocazione

Esito della votazione sul punto 2

Attribuzione dell'utile di esercizio

Elenco Favorevoli

SCHEDA	VPC	NOMINATIVO AZIONISTA	DELEGATO	NUMERO DI AZIONI TOTALE
2366		GMO FOREIGN FUND	CARDARELLI ANGELO	159.311
2391		GMO FUNDS PLC	CARDARELLI ANGELO	56.357
2393		GMO FUNDS PLC	CARDARELLI ANGELO	501.753
1739		GMO GLOBAL EQUITY TRUST	CARDARELLI ANGELO	11.258
1082		GMO IMPLEMENTATION FUND	CARDARELLI ANGELO	2.051.538
2365		GMO INTERNATIONAL EQUITY FUND	CARDARELLI ANGELO	5.933.817
2371		GMO INTERNATIONAL LARGE/MID CAP EQUITY F	CARDARELLI ANGELO	1.052.942
2400		GMO RESOURCES FUND	CARDARELLI ANGELO	14.506
1080		GMO TAX-MANAGED GLOBAL BALANCED PORTFOLIO	CARDARELLI ANGELO	2.512
2362		GMO TAX-MANAGED INTERNATIONAL EQUITIES F	CARDARELLI ANGELO	84.776
2399		GMO WORLD EQUITY ALLOCATION INVESTMENT FU	CARDARELLI ANGELO	205.017
2382		GOLD S SEL INV TR MULTIAS ENH VAL FUND	CARDARELLI ANGELO	38.101
381		GOLDMAN SACHS ETF TRUST- GOLDMAN SACHS ACTIVE BETA INTER. EQUITY	CARDARELLI ANGELO	6.471
382		GOLDMAN SACHS ETF TRUST-GOLDMANSACHS ACTIVE BETA EUROPE EQITY	CARDARELLI ANGELO	4.264
1374		GOLDMAN SACHS FUNDS	CARDARELLI ANGELO	51.179
1375		GOLDMAN SACHS FUNDS	CARDARELLI ANGELO	15.054
1376		GOLDMAN SACHS FUNDS	CARDARELLI ANGELO	305.671
1377		GOLDMAN SACHS FUNDS	CARDARELLI ANGELO	169.685
1378		GOLDMAN SACHS FUNDS II	CARDARELLI ANGELO	6.886
291		GOLDMAN SACHS INSTITUTIONAL FUNDS PLC	CARDARELLI ANGELO	54.148
2958		GOLDMAN SACHS STRUCTURED INTERNATIONAL T	CARDARELLI ANGELO	296.582
3102		GOLDMAN SACHS TRUST - GOLDMAN SACHS INTE	CARDARELLI ANGELO	121.624
2957		GOLDMAN SACHS TRUST - GOLDMAN SACHS STRUCTURED INTERNATIONAL TAX-MANAGED EQUITY	CARDARELLI ANGELO	394.622

ASSEMBLEA ORDINARIA 12 MAGGIO 2016

Segreteria Societaria - Ufficio Titoli



eni

81607/1085

Handwritten signature

Unica convocazione

Esito della votazione sul punto 2

Attribuzione dell'utile di esercizio

Elenco Favorevoli

SCHEDA	VPC	NOMINATIVO AZIONISTA	DELEGATO	NUMERO DI AZIONI TOTALE
923		GOLDMAN SACHS TRUST II - MULTI-MANAGER INTERNL EQUITY FUND	CARDARELLI ANGELO	21.241
1704		GOLDMAN SACHS UK RETIREMENT PLAN	CARDARELLI ANGELO	2.869
372		GOUDSE LEVENVERZEKERINGEN N.V.	CARDARELLI ANGELO	42.500
1197		GOV OF HM THE SULTAN AND YANG DI-PERTUAN OF BRUNEI DARUSSALAM	CARDARELLI ANGELO	116.223
380		GOVERNMENT EMPLOYEES PENSION FUND	CARDARELLI ANGELO	336.567
1668		GOVERNMENT INSTITUTIONS PENSION FUND	CARDARELLI ANGELO	90.886
86		GOVERNMENT OF NORWAY	CARDARELLI ANGELO	50.710.595
2844		GOVERNMENT SUPERANNUATION FUND	CARDARELLI ANGELO	26.139
2845		GOVERNMENT SUPERANNUATION FUND	CARDARELLI ANGELO	126.375
2674		GP 1 VITALITE FCPE	CARDARELLI ANGELO	8.000
2673		GP 2 CROISSANCE FCPE	CARDARELLI ANGELO	6.000
2672		GP 3 MATURITE FCPE	CARDARELLI ANGELO	2.000
379		GRAND LODGE OF FREE AND ACCEPTED MASONS OF CALIFORNIA	CARDARELLI ANGELO	50.682
815		GRD 18 ACTIONS	CARDARELLI ANGELO	71.486
753		GRD ACTIONS ZONE EURO	CARDARELLI ANGELO	131.970
1842		GRIFFIN FAMILY TRUST	CARDARELLI ANGELO	62.052
2720		GROUPE E I M I	CARDARELLI ANGELO	553
605		GROWTH AND INCOME CLASS (GWLIM)	CARDARELLI ANGELO	19.145
265		GS TACS MARKET CONTINUOUS (INTL) LLC	CARDARELLI ANGELO	185.999
328		GUGGENHEIM VARIABLE FUNDS TRUSTSERIES D (WORLD EQUITY INCOMES)	CARDARELLI ANGELO	36.500
1785		GUIDE STONE FUNDS INTERNATIONAL EQUITY INDEX FUNDS	CARDARELLI ANGELO	24.812
250		GUIDEMARK WORLD EX - US FUND	CARDARELLI ANGELO	3.143
1786		GUIDESTONE FUNDS GLOBAL NATURAL RESOURCES EQUITY FUND	CARDARELLI ANGELO	59.246

Handwritten signature

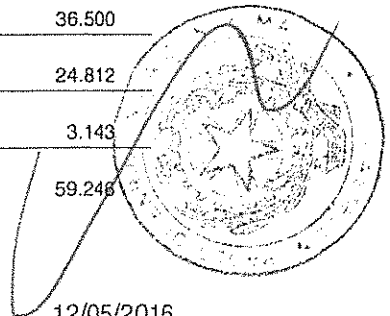

ASSEMBLEA ORDINARIA

81607/1086 12 MAGGIO 2016

Segreteria Societaria - Ufficio Titoli



eni

Unica convocazione

Esito della votazione sul punto 2

Attribuzione dell'utile di esercizio

Elenco Favorevoli

SCHEDA	VPC	NOMINATIVO AZIONISTA	DELEGATO	NUMERO DI AZIONI TOTALE
1780		GUIDESTONE FUNDS INTERNATIONAL EQUITY FUND	CARDARELLI ANGELO	481.185
1781		GUIDESTONE FUNDS INTERNATIONAL EQUITY FUND	CARDARELLI ANGELO	311.280
2830		H.E.S.T. AUSTRALIA LIMITED	CARDARELLI ANGELO	60.481
2831		H.E.S.T. AUSTRALIA LIMITED	CARDARELLI ANGELO	25.931
2832		H.E.S.T. AUSTRALIA LIMITED	CARDARELLI ANGELO	13.980
2833		H.E.S.T. AUSTRALIA LIMITED	CARDARELLI ANGELO	31.628
1884		HAGFORS LIMITED	CARDARELLI ANGELO	59.152
2255		HALEVY A2	CARDARELLI ANGELO	142.677
1992		HALIFAX REGIONAL MUNICIPALITY MASTER TRUST	CARDARELLI ANGELO	2.898
1993		HALIFAX REGIONAL MUNICIPALITY MASTER TRUST	CARDARELLI ANGELO	12.176
1994		HALIFAX REGIONAL MUNICIPALITY MASTER TRUST	CARDARELLI ANGELO	2.855
799		HAMELIN DIVERSIFIE PERP	CARDARELLI ANGELO	700
3081		HANDELSBANKENS EUROPAFOND INDEX	CARDARELLI ANGELO	246.449
138		HARMO PLACEMENT 2	CARDARELLI ANGELO	50.630
482		HARMONY OVERSEAS EQUITY POOL	CARDARELLI ANGELO	40.821
418		HARRIS UNIT 1 QUALIFIED NUCLEARDECOMMISSIONING FUND	CARDARELLI ANGELO	7.562
1063		HARTFORD HEALTHCARE CORP DEFINED BENEFIT MASTER TR AGREEMENT	CARDARELLI ANGELO	34.837
1062		HARTFORD HEALTHCARE ENDOWMENT LLC	CARDARELLI ANGELO	25.312
2242		HARTFORD INTERNATIONAL	CARDARELLI ANGELO	52.510
1054		HARTFORD INTERNATIONAL EQUITY FUND	CARDARELLI ANGELO	12.075
1051		HARTFORD INTERNATIONAL OPPORTUNITIES HLS FUND	CARDARELLI ANGELO	574.168
1137		HARTFORD LIFE INSURANCE COMPANY	CARDARELLI ANGELO	16.569
3107		HARTFORD LIFE INSURANCE COMPANY	CARDARELLI ANGELO	61.823

ASSEMBLEA ORDINARIA 12 MAGGIO 2016

Segreteria Societaria - Ufficio Titoli



eni

81607/1087

Vincenzo

Unica convocazione

Esito della votazione sul punto 2

Attribuzione dell'utile di esercizio

Elenco Favorevoli

SCHEDA	VPC	NOMINATIVO AZIONISTA	DELEGATO	NUMERO DI AZIONI TOTALE
1689		HBOS INTERNATIONAL INV FUNDS ICVC- EUROPEAN FUND	CARDARELLI ANGELO	138.404
1690		HBOS INTERNATIONAL INV FUNDS ICVC- INTERNATIONAL GROWTH FUND	CARDARELLI ANGELO	594.574
872		HC CAPITAL TRUST - THE ESG GROWTH PORTFOLIO	CARDARELLI ANGELO	24.930
868		HC CAPITAL TRUST THE COMMODITY RETURNS STRATEGY PORTFOLIO	CARDARELLI ANGELO	427.965
871		HC CAPITAL TRUST THE COMMODITY RETURNS STRATEGY PORTFOLIO	CARDARELLI ANGELO	550.670
873		HC CAPITAL TRUST- THE CATHOLIC SRI GROWTH PORTFOLIO	CARDARELLI ANGELO	4.316
870		HC CAPITAL TRUST- THE INSTITUTIONAL INTERNATIONAL EQUITY PTF	CARDARELLI ANGELO	537.042
448		HCC INTERNATIONAL INSURANCE COMPANY PLC	CARDARELLI ANGELO	1.222
2677		HEINEKEN ENTREPRISE DIVERSIFIE	CARDARELLI ANGELO	1.500
392		HEINZ 1975 PENSION PLAN	CARDARELLI ANGELO	176.097
391		HEINZ MANAGEMENT PENSION PLAN	CARDARELLI ANGELO	40.113
2354		HELABA INVEST KAPITALANLAGEGESELLSCHAFT MBH	CARDARELLI ANGELO	45.800
2485		HENDERSON EUROPEAN ENHANCED EQ.	CARDARELLI ANGELO	240.546
2503		HENDERSON GLOBAL INVESTORS	CARDARELLI ANGELO	1.325.095
1103		HENKEL OF AMERICA MASTER RETIREMENT TRUST	CARDARELLI ANGELO	27.644
1066		HEXAVEST ACWI EQUITY FUND	CARDARELLI ANGELO	3.029
1065		HEXAVEST EAFE EQUITY FUND	CARDARELLI ANGELO	58.452
3248		HEXAVEST EUROPE FUND	CARDARELLI ANGELO	250.154
1067		HEXAVEST WORLD EQUITY FUND	CARDARELLI ANGELO	35.083
1861		HF FUND, LP	CARDARELLI ANGELO	26.323
2563		HFZH COFONDS	CARDARELLI ANGELO	30.000
562		HIGHLAND EQUITY COLLECTIVE FUND	CARDARELLI ANGELO	204.568
559		HIGHLAND EQUITY FUND	CARDARELLI ANGELO	331.692

Vincenzo

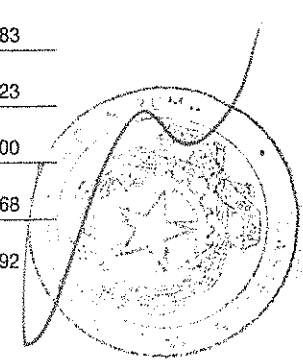

ASSEMBLEA ORDINARIA

81607/1088 12 MAGGIO 2016

Segreteria Societaria - Ufficio Titoli



eni

Unica convocazione

Esito della votazione sul punto 2

Attribuzione dell'utile di esercizio

Elenco Favorevoli

SCHEDA	VPC	NOMINATIVO AZIONISTA	DELEGATO	NUMERO DI AZIONI TOTALE
560		HIGHLAND PUBLIC INFLATION HEDGES FUND	CARDARELLI ANGELO	73.758
563		HIGHLAND PUBLIC INFLATION HEDGES FUND	CARDARELLI ANGELO	37.755
869		HIRTLE CALLAGHAN TRUST INTERNATIONAL EQUITY PORTFOLIO	CARDARELLI ANGELO	215.358
3123		HOBART FAMILY INVESTMENTS LLC	CARDARELLI ANGELO	3.141
1948		HONEYWELL INTERNATIONAL INC MASTER RETIREMENT TRUST	CARDARELLI ANGELO	429.300
1812		HONG KONG SAR GOVERNMENT EXCHANGE FUND	CARDARELLI ANGELO	2.025.441
1813		HONG KONG SAR GOVERNMENT EXCHANGE FUND	CARDARELLI ANGELO	385.921
1192		HONG KONG SPECIAL ADMINISTRATIVE REGION GOVERNMENT-EXCHANGE F	CARDARELLI ANGELO	283.469
1211		HONGKONG ELECTRIC DEFINED CONTRIBUTION SCHEME	CARDARELLI ANGELO	4.514
1808		HOSPITAL AUTHORITY PROVIDENT FUND SCHEME	CARDARELLI ANGELO	330.712
1809		HOSPITAL AUTHORITY PROVIDENT FUND SCHEME	CARDARELLI ANGELO	224.743
2632		HRW TESTAMENTARY TRUST NO 1	CARDARELLI ANGELO	79.969
2633		HRW TESTAMENTARY TRUST NO 2	CARDARELLI ANGELO	30.824
1932		HRW TESTAMENTARY TRUST NO 3	CARDARELLI ANGELO	6.424
1939		HRW TESTAMENTARY TRUST NO 4	CARDARELLI ANGELO	8.635
1931		HRW TESTAMENTARY TRUST NO 5	CARDARELLI ANGELO	15.206
1937		HRW TESTAMENTARY TRUST NO 6	CARDARELLI ANGELO	12.948
1942		HRW TESTAMENTARY TRUST NO 7	CARDARELLI ANGELO	5.162
1936		HRW TESTAMENTARY TRUST NO 8	CARDARELLI ANGELO	7.037
1775		HRW TESTAMENTARY TRUST NO. 10	CARDARELLI ANGELO	15.313
1935		HRW TESTAMENTARY TRUST NO. 11	CARDARELLI ANGELO	16.626
1943		HRW TESTAMENTARY TRUST NO. 12	CARDARELLI ANGELO	22.162
1940		HRW TESTAMENTARY TRUST NO. 7	CARDARELLI ANGELO	3.720

ASSEMBLEA ORDINARIA 12 MAGGIO 2016

Segreteria Societaria - Ufficio Titoli



eni

81607/1039

[Handwritten signature]

Unica convocazione

Esito della votazione sul punto 2

Attribuzione dell'utile di esercizio

Elenco Favorevoli

SCHEDA	VPC	NOMINATIVO AZIONISTA	DELEGATO	NUMERO DI AZIONI TOTALE
1938		HRW TESTAMENTARY TRUST NO. 8	CARDARELLI ANGELO	11.282
1776		HRW TESTAMENTARY TRUST NO. 9	CARDARELLI ANGELO	15.203
1934		HRW TRUST NO 1 UAD 01/17/03	CARDARELLI ANGELO	9.935
1933		HRW TRUST NO 2 UAD 01/17/03	CARDARELLI ANGELO	11.295
1944		HRW TRUST NO 3 UAD 01/17/03	CARDARELLI ANGELO	11.924
1941		HRW TRUST NO 4 UAD 01/17/03	CARDARELLI ANGELO	11.151
1787		HSBC - NORTH AMERICA (U.S.) PENSION TRUST	CARDARELLI ANGELO	200.450
1683		HSBC AS TRUSTEE FOR SSGA EUROPE EX UK EQUITY TRACKER FUND	CARDARELLI ANGELO	1.592.966
3180		HSBC BALANCED FUND	CARDARELLI ANGELO	86.387
3196		HSBC ETFS PLC	CARDARELLI ANGELO	198.678
3197		HSBC ETFS PUBLIC LTD C HSBC WORLDWIDE	CARDARELLI ANGELO	19.851
1990		HSBC EUROPEAN FUND	CARDARELLI ANGELO	45.902
3257		HSBC EUROPEAN GROWTH FUND	CARDARELLI ANGELO	434.260
3179		HSBC EUROPEAN INDEX FUND	CARDARELLI ANGELO	535.544
3192		HSBC FTSE EPRA/NAREIT DEVELOPED ETF	CARDARELLI ANGELO	127.623
3194		HSBC GLOBAL INVESTMENT FUNDS	CARDARELLI ANGELO	67.711
2427		HSBC GROUP HONG KONG LOCAL STAFF RETIREMENT BENEFIT SCHEME	CARDARELLI ANGELO	12.620
1991		HSBC INTERNATIONAL EQUITY POOLED FUND	CARDARELLI ANGELO	264.765
3181		HSBC LIFE (UK) LIMITED	CARDARELLI ANGELO	36.183
2431		HSBC MANAGED BALANCED FUND	CARDARELLI ANGELO	15.189
2430		HSBC MANAGED GROWTH FUND	CARDARELLI ANGELO	28.616
2429		HSBC MANAGED STABLE FUND	CARDARELLI ANGELO	5.278
2428		HSBC MANAGED STABLE GROWTH FUND	CARDARELLI ANGELO	1.958

[Handwritten signature]

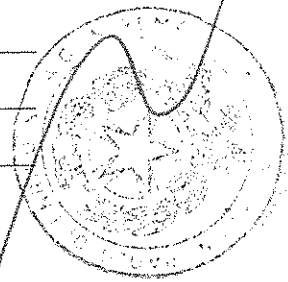

ASSEMBLEA ORDINARIA

81607/1090 12 MAGGIO 2016

Segreteria Societaria - Ufficio Titoli



eni

Unica convocazione

Esito della votazione sul punto 2

Attribuzione dell'utile di esercizio

Elenco Favorevoli

SCHEDA	VPC	NOMINATIVO AZIONISTA	DELEGATO	NUMERO DI AZIONI TOTALE
3193		HSBC MSCI EUROPE UCITS ETF	CARDARELLI ANGELO	88.404
2045		HSBC UCITS COMMON CONTRACTUAL FUND	CARDARELLI ANGELO	24.915
1907		HUBBELL INCORPORATED MASTER PENSION TRUST	CARDARELLI ANGELO	4.260
137		HYMNOS L113	CARDARELLI ANGELO	3.187
2443		I CROISSANCE	CARDARELLI ANGELO	31.235
804		I.2.C. ACTIONS	CARDARELLI ANGELO	160.000
531		IBERDROLA USA DEFINED BENEFIT MASTER TRUST I	CARDARELLI ANGELO	47.930
532		IBERDROLA USA DEFINED BENEFIT MASTER TRUST I	CARDARELLI ANGELO	23.845
1495		IBM 401K PLUS PLAN	CARDARELLI ANGELO	413.194
1997		IBM DIVERSIFIED GLOBAL EQUITY FUND	CARDARELLI ANGELO	47.059
1998		IBM DIVERSIFIED GLOBAL EQUITY FUND	CARDARELLI ANGELO	108.699
1999		IBM DIVERSIFIED GLOBAL EQUITY FUND	CARDARELLI ANGELO	68.881
204		IBM FRANCE	CARDARELLI ANGELO	56.000
743		IBM H	CARDARELLI ANGELO	6.300
2900		IBM PERSONAL PENSION PLAN TRUST	CARDARELLI ANGELO	82.727
3096		IBM PERSONAL PENSION PLAN TRUST	CARDARELLI ANGELO	112.045
1503		IBM RETIREMENT PLAN	CARDARELLI ANGELO	20.000
805		IDEAM SOLIDARITES	CARDARELLI ANGELO	2.943
2349		IFAG NATURAL RESOURCES FUND	CARDARELLI ANGELO	232.496
569		IG TEMPLETON INTERNATIONAL EQUITY CLASS	CARDARELLI ANGELO	32.762
566		IG TEMPLETON INTERNATIONAL EQUITY FD	CARDARELLI ANGELO	143.042
1966		ILLINOIS MUNICIPAL RETIREMENT FUND	CARDARELLI ANGELO	881.956
1967		ILLINOIS MUNICIPAL RETIREMENT FUND	CARDARELLI ANGELO	749.369

ASSEMBLEA ORDINARIA 12 MAGGIO 2016

Segreteria Societaria - Ufficio Titoli



eni

Unica convocazione

Esito della votazione sul punto 2

Attribuzione dell'utile di esercizio

81607/1091

Msc

Elenco Favorevoli

SCHEDA	VPC	NOMINATIVO AZIONISTA	DELEGATO	NUMERO DI AZIONI TOTALE
1564		ILLINOIS STATE BOARD OF INVESTMENT	CARDARELLI ANGELO	176.915
1465		IMPACT GLOBAL ALPHA TILTS NON-LENDABLE FUND B	CARDARELLI ANGELO	1.682
686		IMPERIAL INTERNATIONAL EQUITY POOL	CARDARELLI ANGELO	768.825
687		IMPERIAL INTERNATIONAL EQUITY POOL	CARDARELLI ANGELO	76.074
688		IMPERIAL INTERNATIONAL EQUITY POOL	CARDARELLI ANGELO	39.516
689		IMPERIAL OVERSEAS EQUITY POOL	CARDARELLI ANGELO	34.475
2733		INDEX MOTHER FUND EURO AREA EQUITY	CARDARELLI ANGELO	670
570		INDIANA UNIVERSITY FOUNDATION	CARDARELLI ANGELO	64.046
747		INDOCAM FLAMME	CARDARELLI ANGELO	57.244
2381		ING DIRECT	CARDARELLI ANGELO	183.006
357		ING DIVIDEND AANDELEN FUND	CARDARELLI ANGELO	92.294
298		ING FUNDS SERVICES, LLC	CARDARELLI ANGELO	150.921
248		ING GLOBAL EQUITY DIVIDEND FUND	CARDARELLI ANGELO	55.486
356		ING INSTITUTIONEEL DIVIDEND AANDELEN FONDS	CARDARELLI ANGELO	125.291
336		ING INVESTMENT MANAGEMENT	CARDARELLI ANGELO	169.503
1908		INOVA HEALTH SYSTEM FOUNDATION	CARDARELLI ANGELO	135.580
1089		INTECH GLOBAL ALL COUNTRY ENHANCED INDEX FUND LLC	CARDARELLI ANGELO	1.776
1769		INTEGRYS ENERGY GROUP RETIREMENT PLAN TRUST	CARDARELLI ANGELO	148.672
1187		INTEL CORPORATION RETIREE MEDICAL PLAN TRUST	CARDARELLI ANGELO	38.854
1834		INTER AMERICAN DEVELOPMENT BANK STAFF RETIREMENT FUND	CARDARELLI ANGELO	29.459
1598		INTERNATIONAL ALPHA SELECT COMMON TRUST FUND	CARDARELLI ANGELO	226.984
1470		INTERNATIONAL ALPHA TILTS FUND B	CARDARELLI ANGELO	92.493
710		INTERNATIONAL BANK FOR RECONSTRUCTION AND DEVELOPMENT	CARDARELLI ANGELO	9.604

Msc

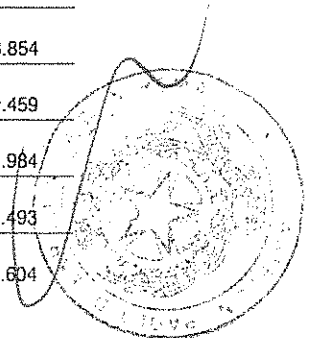

ASSEMBLEA ORDINARIA

81607/1092 12 MAGGIO 2016

Segreteria Societaria - Ufficio Titoli



eni

Unica convocazione

Esito della votazione sul punto 2

Attribuzione dell'utile di esercizio

Elenco Favorevoli

SCHEDA	VPC	NOMINATIVO AZIONISTA	DELEGATO	NUMERO DI AZIONI TOTALE
711		INTERNATIONAL BANK FOR RECONSTRUCTION AND DEVELOPMENT	CARDARELLI ANGELO	57.212
712		INTERNATIONAL BANK FOR RECONSTRUCTION AND DEVELOPMENT	CARDARELLI ANGELO	17.766
1811		INTERNATIONAL EQUITY FUND	CARDARELLI ANGELO	33.053
1455		INTERNATIONAL EQUITY INDEX PLUS FUNDS B	CARDARELLI ANGELO	16.566
918		INTERNATIONAL EXPATRIATE BENEFIT MASTER TRUST	CARDARELLI ANGELO	13.493
3053		INTERNATIONAL FUND MANAGEMENT S.A. RE IF	CARDARELLI ANGELO	1.115.920
3051		INTERNATIONAL FUND MANGEMENT S.A. RE GLO	CARDARELLI ANGELO	4.300
3052		INTERNATIONAL FUND MANGEMENT S.A. RE IFM	CARDARELLI ANGELO	200.000
1159		INTERNATIONAL INVESTMENT FUND	CARDARELLI ANGELO	8.759
1160		INTERNATIONAL INVESTMENT FUND	CARDARELLI ANGELO	22.338
924		INTERNATIONAL MONETARY FUND	CARDARELLI ANGELO	33.802
925		INTERNATIONAL MONETARY FUND	CARDARELLI ANGELO	45.552
1836		INTERNATIONAL MONETARY FUND STAFF RETIREMENT PLAN	CARDARELLI ANGELO	4.605
1837		INTERNATIONAL MONETARY FUND STAFF RETIREMENT PLAN	CARDARELLI ANGELO	2.626
915		INTERNATIONAL PAPER CO COMMINGLED INVESTMENT GROUP TRUST	CARDARELLI ANGELO	405.750
1490		INTERNATIONAL PAPER CO COMMINGLED INVESTMENT GROUP TRUST	CARDARELLI ANGELO	121.271
1491		INTERNATIONAL PAPER CO COMMINGLED INVESTMENT GROUP TRUST	CARDARELLI ANGELO	139.859
1454		INTERNATIONAL TILTS MASTER PORTFOLIO OF MASTER INVESTMENT PTF	CARDARELLI ANGELO	60.217
1810		INTERVENTURE EQUITY INVESTMENTS LIMITED	CARDARELLI ANGELO	9.652
1101		INVESCO MACRO INTERNATIONAL EQUITY FUND	CARDARELLI ANGELO	365
1102		INVESCO MACRO LONG/SHORT FUND	CARDARELLI ANGELO	444
1661		INVESTEC FUNDS SERIES II GLOBAL ENERGY FUND	CARDARELLI ANGELO	175.251
1343		INVESTEC GLOBAL STRATEGY FUND	CARDARELLI ANGELO	1.093.055

ASSEMBLEA ORDINARIA 12 MAGGIO 2016

Segreteria Societaria - Ufficio Titoli



eni

81607/1093

Handwritten signature

Unica convocazione

Esito della votazione sul punto 2

Attribuzione dell'utile di esercizio

Elenco Favorevoli

SCHEDA	VPC	NOMINATIVO AZIONISTA	DELEGATO	NUMERO DI AZIONI TOTALE
290		INVESTERINGSFORENINGEN SPARINVEST CUMULUS VALUE CARDARELLI ANGELO		31.359
285		INVESTERINGSFORENINGEN SPARINVEST INDEX DOW JONES SUSTAINABILITYWORLD CARDARELLI ANGELO		24.000
282		INVESTERINGSFORENINGEN SPARINVEST INDEX EUROPA VALUE CARDARELLI ANGELO		44.011
283		INVESTERINGSFORENINGEN SPARINVEST INDEX GLOBAL AKTIER MIN.RISIKO CARDARELLI ANGELO		47.100
287		INVESTERINGSFORENINGEN SPARINVEST VALUE AKTIER CARDARELLI ANGELO		379.131
294		INVESTERINGSFORENINGEN SPARINVEST VALUE EUROPA CARDARELLI ANGELO		117.820
347		INVESTIN PRO F.M.B.A., GLOBAL EQUITIES I CARDARELLI ANGELO		108.387
195		INVESTISSEMENT TRESOR VIE CARDARELLI ANGELO		27.360
568		IOWA PUBLIC EMPLOYEES RETIREMENT SYSTEM CARDARELLI ANGELO		498.661
2622		IPAC SPEC INV STR INT SHARE STR no 9 CARDARELLI ANGELO		266.241
2623		IPAC SPEC INV STR INT SHARE STR no 9 CARDARELLI ANGELO		18.163
2099		IPM EQUITY UMBRELLA FUND CARDARELLI ANGELO		13.715
2100		IPM EQUITY UMBRELLA FUND CARDARELLI ANGELO		8.351
1076		IPSOL GLOBAL EQUITY FUND CARDARELLI ANGELO		7.975
390		IQ 50 PERCENT HEDGED FTSE EUROPE ETF CARDARELLI ANGELO		14.404
403		IQ 50 PERCENT HEDGED FTSE INTERNATIONAL ETF CARDARELLI ANGELO		15.168
274		IQ ARB GLOBAL RESOURCES ETF CARDARELLI ANGELO		20.999
2448		IRCOM RETRAITE DIVERSIFIE CARDARELLI ANGELO		64.760
22		IRISH LIFE ASSURANCE CARDARELLI ANGELO		1.249.845
3252		IRISH LIFE ASSURANCE PLC CARDARELLI ANGELO		67.866
3305		IRISH LIFE ASSURANCE PLC CARDARELLI ANGELO		158.220
3306		IRISH LIFE ASSURANCE PLC CARDARELLI ANGELO		2.110.756
1424		ISHARES CORE MSCI EAFE ETF CARDARELLI ANGELO		2.034.012

Handwritten signature

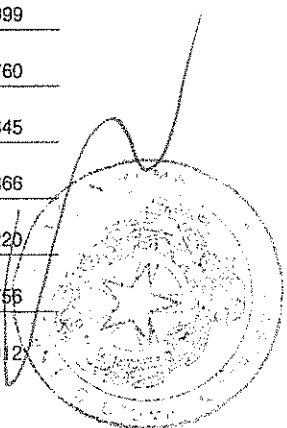

ASSEMBLEA ORDINARIA

81607/2094 12 MAGGIO 2016

Segreteria Societaria - Ufficio Titoli



eni

Unica convocazione

Esito della votazione sul punto 2

Attribuzione dell'utile di esercizio

Elenco Favorevoli

SCHEDA	VPC	NOMINATIVO AZIONISTA	DELEGATO	NUMERO DI AZIONI TOTALE
1427		ISHARES CORE MSCI EAFE IMI INDEX ETF	CARDARELLI ANGELO	77.716
1429		ISHARES CORE MSCI EUROPE ETF	CARDARELLI ANGELO	266.639
1425		ISHARES CORE MSCI TOTAL INTERNATIONAL STOCK ETF	CARDARELLI ANGELO	257.185
1410		ISHARES EUROPE ETF	CARDARELLI ANGELO	963.739
1413		ISHARES GLOBAL ENERGY ETF	CARDARELLI ANGELO	1.356.870
1433		ISHARES GLOBAL MONTHLY DIVIDEND INDEX ETF (CAD-HEDGED)	CARDARELLI ANGELO	48.799
1642		ISHARES I INV MIT TGV F ISHS ST EUROPE600 OIL+GAS UCITS ETF DE	CARDARELLI ANGELO	4.200.501
1607		ISHARES II PUBLIC LIMITED COMPANY	CARDARELLI ANGELO	1.773.998
1609		ISHARES II PUBLIC LIMITED COMPANY	CARDARELLI ANGELO	454.756
1610		ISHARES II PUBLIC LIMITED COMPANY	CARDARELLI ANGELO	6.789.699
1614		ISHARES II PUBLIC LIMITED COMPANY	CARDARELLI ANGELO	2.058.646
1618		ISHARES II PUBLIC LIMITED COMPANY	CARDARELLI ANGELO	24.861
1622		ISHARES II PUBLIC LIMITED COMPANY	CARDARELLI ANGELO	22.973
1623		ISHARES II PUBLIC LIMITED COMPANY	CARDARELLI ANGELO	175.210
1616		ISHARES III PUBLIC LIMITED COMPANY	CARDARELLI ANGELO	492.530
1619		ISHARES III PUBLIC LIMITED COMPANY	CARDARELLI ANGELO	187.125
1432		ISHARES INTERNATIONAL FUNDAMENTAL INDEX ETF	CARDARELLI ANGELO	90.782
1417		ISHARES INTERNATIONAL SELECT DIVIDEND ETF	CARDARELLI ANGELO	3.303.034
1626		ISHARES IV PUBLIC LIMITED COMPANY	CARDARELLI ANGELO	169.381
1631		ISHARES IV PUBLIC LIMITED COMPANY	CARDARELLI ANGELO	35.010
1408		ISHARES MSCI ACWI ETF	CARDARELLI ANGELO	351.848
1409		ISHARES MSCI ACWI EX US ETF	CARDARELLI ANGELO	262.260
1411		ISHARES MSCI EAFE ETF	CARDARELLI ANGELO	12.355.938

ASSEMBLEA ORDINARIA 12 MAGGIO 2016

Segreteria Societaria - Ufficio Titoli



eni

Handwritten signature

Unica convocazione

Esito della votazione sul punto 2

Attribuzione dell'utile di esercizio

81607/1095

Elenco Favorevoli

SCHEDA	VPC	NOMINATIVO AZIONISTA	DELEGATO	NUMERO DI AZIONI TOTALE
1412		ISHARES MSCI EAFE VALUE ETF	CARDARELLI ANGELO	1.157.880
1428		ISHARES MSCI EUROPE IMI INDEX ETF	CARDARELLI ANGELO	46.838
1414		ISHARES MSCI EUROZONE ETF	CARDARELLI ANGELO	8.220.047
1423		ISHARES MSCI GLOBAL ENERGY PRODUCERS ETF	CARDARELLI ANGELO	45.163
1431		ISHARES MSCI INTERNATIONAL DEVELOPED SIZE FACTOR ETF	CARDARELLI ANGELO	291
1430		ISHARES MSCI INTERNATIONAL DEVELOPED VALUE FACTOR ETF	CARDARELLI ANGELO	11.178
1415		ISHARES MSCI ITALY CAPPED ETF	CARDARELLI ANGELO	6.973.233
1416		ISHARES MSCI KOKUSAI ETF	CARDARELLI ANGELO	23.374
1426		ISHARES MSCI WORLD ETF	CARDARELLI ANGELO	19.795
1608		ISHARES PUBLIC LIMITED COMPANY	CARDARELLI ANGELO	176.374
1611		ISHARES PUBLIC LIMITED COMPANY	CARDARELLI ANGELO	26.644
1612		ISHARES PUBLIC LIMITED COMPANY	CARDARELLI ANGELO	33.693
1615		ISHARES PUBLIC LIMITED COMPANY	CARDARELLI ANGELO	778.453
1617		ISHARES PUBLIC LIMITED COMPANY	CARDARELLI ANGELO	448.427
1633		ISHARES PUBLIC LIMITED COMPANY	CARDARELLI ANGELO	22.820
1613		ISHARES V PUBLIC LIMITED COMPANY	CARDARELLI ANGELO	19.583
1620		ISHARES V PUBLIC LIMITED COMPANY	CARDARELLI ANGELO	46.080
1621		ISHARES V PUBLIC LIMITED COMPANY	CARDARELLI ANGELO	14.209
1624		ISHARES VI PUBLIC LIMITED COMPANY	CARDARELLI ANGELO	22.192
1625		ISHARES VI PUBLIC LIMITED COMPANY	CARDARELLI ANGELO	66.669
1627		ISHARES VII PLC	CARDARELLI ANGELO	1.892.411
1628		ISHARES VII PLC	CARDARELLI ANGELO	1.749.798
1629		ISHARES VII PLC	CARDARELLI ANGELO	961.578

Handwritten signature

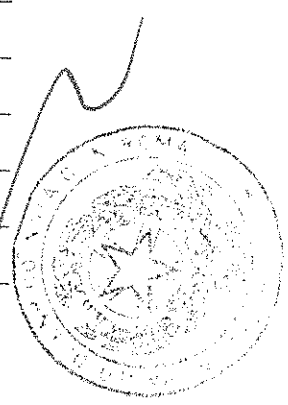

ASSEMBLEA ORDINARIA

81607/109612 MAGGIO 2016

Segreteria Societaria - Ufficio Titoli



eni

Unica convocazione

Esito della votazione sul punto 2

Attribuzione dell'utile di esercizio

Elenco Favorevoli

SCHEDA	VPC	NOMINATIVO AZIONISTA	DELEGATO	NUMERO DI AZIONI TOTALE
1630		ISHARES VII PLC	CARDARELLI ANGELO	29.381
1632		ISHARES VII PLC	CARDARELLI ANGELO	19.455
571		IUOE LOCAL 793 MEMBERS PENSION BENEFIT TRUST OF ONTARIO	CARDARELLI ANGELO	36.531
409		IVY APOLLO MULTI-ASSET INCOME FUND	CARDARELLI ANGELO	66.519
313		IVY GLOBAL EQUITY INCOME FUND	CARDARELLI ANGELO	282.201
148		IXIS EURO ACTIONS	CARDARELLI ANGELO	325.550
788		IXIS FLAMME	CARDARELLI ANGELO	34.717
442		JANA PASSIVE GLOBAL SHARE TRUST	CARDARELLI ANGELO	182.223
1135		JANUS ADAPTIVE GLOBAL ALLOCATION FUND	CARDARELLI ANGELO	532
79		JANUS CAPITAL FUNDS PLC	CARDARELLI ANGELO	71
1085		JANUS CAPITAL MANAGEMENT LLC	CARDARELLI ANGELO	189
2372		JAPAN TRUSTEE SERVICES BANK LTD	CARDARELLI ANGELO	10.824
2373		JAPAN TRUSTEE SERVICES BANK LTD	CARDARELLI ANGELO	10.225
2384		JAPAN TRUSTEE SERVICES BANK LTD	CARDARELLI ANGELO	3.900
2392		JAPAN TRUSTEE SERVICES BANK LTD	CARDARELLI ANGELO	63.920
2395		JAPAN TRUSTEE SERVICES BANK LTD	CARDARELLI ANGELO	4.621
3092		JAPAN TRUSTEE SERVICES BANK LTD AS TRUSTEE FOR SUMITOMO MITSUI TRUST AS TRUSTEE FOI	CARDARELLI ANGELO	167.700
46		JAPAN TRUSTEE SERVICES BANK, LTD	CARDARELLI ANGELO	54.764
3120		JEFFREY LLC	CARDARELLI ANGELO	46.949
3129		JEWISH COMMUNAL FUND	CARDARELLI ANGELO	144.496
2949		JNL/FRANKLIN TEMPLETON GLOBAL GROWTH FUN	CARDARELLI ANGELO	608.917
2948		JNL/MELLON CAPITAL INTNAL INDEX FUND	CARDARELLI ANGELO	467.435
3231		JO HAMBRO CAPITAL MANAGEMENT UMBRELLA FU	CARDARELLI ANGELO	801.338

ASSEMBLEA ORDINARIA 12 MAGGIO 2016

Segreteria Societaria - Ufficio Titoli

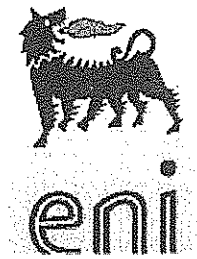

Unica convocazione

Esito della votazione sul punto 2

Attribuzione dell'utile di esercizio

81607/1097 *Scor*

Elenco Favorevoli

SCHEDA	VPC	NOMINATIVO AZIONISTA	DELEGATO	NUMERO DI AZIONI TOTALE
722		JOHN D SPEARS GRAT I DTD 2 20 2009 FBO NANA SPEARS	CARDARELLI ANGELO	5.225
694		JOHN D SPEARS GRAT I DTD 2/20/2009 FBO JULIE SPEARS	CARDARELLI ANGELO	5.700
693		JOHN D SPEARS GRAT I DTD 2/20/2009 FBO LUCY SPEARS	CARDARELLI ANGELO	5.525
691		JOHN D. SPEARS	CARDARELLI ANGELO	61.500
692		JOHN D. SPEARS	CARDARELLI ANGELO	1.975
573		JOHN DEERE PENSION TRUST .	CARDARELLI ANGELO	138.773
574		JOHN DEERE PENSION TRUST .	CARDARELLI ANGELO	269.828
898		JOHN HANCOCK DISCIPLINED VALUE INTERNATIONAL FUND	CARDARELLI ANGELO	92.331
65		JOHN HANCOCK FUNDS II INTERNATIONAL VALUE FUND	CARDARELLI ANGELO	1.068.720
897		JOHN HANCOCK FUNDS II STRATEGIC EQUITY ALLOCATION FUND	CARDARELLI ANGELO	382.766
66		JOHN HANCOCK FUNDS III INTERNATIONAL CORE FUND	CARDARELLI ANGELO	1.128.711
899		JOHN HANCOCK HEDGED EQUITY AND INCOME FUND	CARDARELLI ANGELO	29.320
1541		JOHN HANCOCK INSURANCE COMPANY OF VERMONT	CARDARELLI ANGELO	11.573
936		JOHN HANCOCK LIFE AND HEALTH INSURANCE COMPANY	CARDARELLI ANGELO	117.032
896		JOHN HANCOCK VAR INS TRUST STRATEGIC EQUITY ALLOCATION TRUST	CARDARELLI ANGELO	629.949
68		JOHN HANCOCK VARIABLE INSURANCE TRUST GLOBAL TRUST	CARDARELLI ANGELO	361.942
69		JOHN HANCOCK VARIABLE INSURANCE TRUST INTERNATIONAL CORE TRUST	CARDARELLI ANGELO	285.399
70		JOHN HANCOCK VARIABLE INSURANCE TRUST INTERNATIONAL EQUITY INDEX TRUST	CARDARELLI ANGELO	83.821
71		JOHN HANCOCK VARIABLE INSURANCE TRUST INTERNATIONAL VALUE TRUST	CARDARELLI ANGELO	555.193
1050		JOHN HANCOCK WORLDWIDE INVESTORS PUBLIC LIMITED COMPANY	CARDARELLI ANGELO	11.172
1088		JOHNSON & JOHNSON PENSION & SAVINGS PLANS MASTER TRUST	CARDARELLI ANGELO	355.094
3099		JP MORGAN CHASE RETIREMENT PLAN	CARDARELLI ANGELO	300.848
577		JP O'SHAUGHNESSY 1982 IRREV TR.	CARDARELLI ANGELO	313

Scor

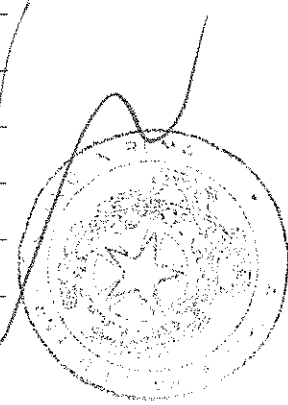

ASSEMBLEA ORDINARIA

81607/109812 MAGGIO 2016

Segreteria Societaria - Ufficio Titoli



eni

Unica convocazione

Esito della votazione sul punto 2

Attribuzione dell'utile di esercizio

Elenco Favorevoli

SCHEDA	VPC	NOMINATIVO AZIONISTA	DELEGATO	NUMERO DI AZIONI TOTALE
967		JP TR SERV BK LTD ATF MATB MSCI KOKUSAI INDEX MOTHER F	CARDARELLI ANGELO	74.125
2853		JPMORGAN CHASE BANK N.A.	CARDARELLI ANGELO	1.328
2854		JPMORGAN CHASE BANK N.A.	CARDARELLI ANGELO	4.224
3128		JPMORGAN DIVERS RETURN EU EQUIT ETF	CARDARELLI ANGELO	35.135
3137		JPMORGAN DIVERSIFIED RETURN GLOBAL EQUIT	CARDARELLI ANGELO	7.420
3040		JPMORGAN EUROPEAN INVESTMENT TRUST PLC	CARDARELLI ANGELO	41.890
2965		JPMORGAN FUND ICVC - JPM EUROPE FUND	CARDARELLI ANGELO	43.525
2758		JPMORGAN FUNDS EUROPEAN BANK AND BC	CARDARELLI ANGELO	1
2759		JPMORGAN FUNDS EUROPEAN BANK AND BC	CARDARELLI ANGELO	5.199
2761		JPMORGAN FUNDS EUROPEAN BANK AND BC	CARDARELLI ANGELO	9.111
2762		JPMORGAN FUNDS EUROPEAN BANK AND BC	CARDARELLI ANGELO	3.872
2765		JPMORGAN FUNDS EUROPEAN BANK AND BC	CARDARELLI ANGELO	224.743
2766		JPMORGAN FUNDS EUROPEAN BANK AND BC	CARDARELLI ANGELO	9.334
3114		JPMORGAN GLOBAL RESEARCH ENHANCED INDEX FUND	CARDARELLI ANGELO	47.936
2369		JTSB STB DAIWA STOCK INDEX FUND 9807	CARDARELLI ANGELO	56.700
1762		JTW TRUST NO. 1 UAD 9/19/02	CARDARELLI ANGELO	6.883
1763		JTW TRUST NO. 2 UAD 9/19/02	CARDARELLI ANGELO	9.784
1761		JTW TRUST NO. 3 UAD 9/19/02	CARDARELLI ANGELO	14.264
1909		JTW TRUST NO. 4 UAD 9/19/02	CARDARELLI ANGELO	11.829
1823		K INVESTMENTS SH LIMITED	CARDARELLI ANGELO	358.199
878		KAISER FOUNDATION HOSPITALS	CARDARELLI ANGELO	87.145
1481		KAISER PERMANENTE GROUP TRUST	CARDARELLI ANGELO	216.308
1106		KANSAS PUBLIC EMPLOYEES RETIREMENT SYSTEM	CARDARELLI ANGELO	334.223

ASSEMBLEA ORDINARIA 12 MAGGIO 2016

Segreteria Societaria - Ufficio Titoli



eni

81607/1099

Handwritten signature

Unica convocazione

Esito della votazione sul punto 2

Attribuzione dell'utile di esercizio

Elenco Favorevoli

SCHEDA	VPC	NOMINATIVO AZIONISTA	DELEGATO	NUMERO DI AZIONI TOTALE
1107		KANSAS PUBLIC EMPLOYEES RETIREMENT SYSTEM	CARDARELLI ANGELO	207
3041		KAPITALFORENINGEN ISTITUTIONEL INVESTOR EUROPAELSKA AKTIER	CARDARELLI ANGELO	517.555
458		KAPITALFORENINGEN SPARINVEST II, VALUE AKTIER (EX FINANS) COIDSPARINVEST	CARDARELLI ANGELO	18.765
3042		KAPITFORENI INSTIT INVEST GLOBALE AKTIER	CARDARELLI ANGELO	42.149
3126		KATHERINE C. MOORE CHARITABLE LEAD ANNUITY TRUST II	CARDARELLI ANGELO	2.342
3127		KATHERINE C. MOORE CHARITABLE LEAD ANNUITY TRUST II	CARDARELLI ANGELO	1.612
3019		KIRCHHEIM UNTER TECK FONDS	CARDARELLI ANGELO	1.400
2068		KLEINWORT BENSON INVESTORS INSTITUTIONAL FUND PLC	CARDARELLI ANGELO	34.736
2069		KLEINWORT BENSON INVESTORS INSTITUTIONAL FUND PLC	CARDARELLI ANGELO	6.513
286		KNIGHTS OF COLUMBUS MASTER TRUST	CARDARELLI ANGELO	5.097
2085		KOMMUNAL LANDSPENSJONSKASSE GJENSIDIG FORSIKRINGSSELSKAP	CARDARELLI ANGELO	198.987
3278		KONSUMENTKOOPERATIONENS PENSIONSSTIFTELS	CARDARELLI ANGELO	6.821
3280		KONSUMENTKOOPERATIONENS PENSIONSSTIFTELS	CARDARELLI ANGELO	34.546
2902		KOOKMIN BANK ACTING AS TRUSTEE OF KIM PRIVATE NOBLE CLASS GLOBAL EQUITY MASTER INVE	CARDARELLI ANGELO	48.208
1104		KP INTERNATIONAL EQUITY FUND	CARDARELLI ANGELO	110.259
1105		KP INTERNATIONAL EQUITY FUND	CARDARELLI ANGELO	72.197
3282		KPA LIVFORSAKRING AB (PUBL)	CARDARELLI ANGELO	9.134
3281		KPA PENSIONSFORSAKRING AB (PUBL)	CARDARELLI ANGELO	334.256
578		KROGER COMPANY MASTER RETIREMENT TRUST	CARDARELLI ANGELO	1.352
2275		LA BANQUE POSTALE ASSET MANAG	CARDARELLI ANGELO	43.000
196		LA BANQUE POSTALE DE PREVOYANCE	CARDARELLI ANGELO	137.000
2489		LABEL EUROPE ACTIONS FCP	CARDARELLI ANGELO	240.000
3073		LABOR PENSION FUND SUPERVISORY COMMITTEE	CARDARELLI ANGELO	294.415

Handwritten signature



ASSEMBLEA ORDINARIA

81607/1100 12 MAGGIO 2016

Segreteria Societaria - Ufficio Titoli



eni

Unica convocazione

Esito della votazione sul punto 2

Attribuzione dell'utile di esercizio

Elenco Favorevoli

SCHEDA	VPC	NOMINATIVO AZIONISTA	DELEGATO	NUMERO DI AZIONI TOTALE
1845		LAKE AVENUE INVESTMENTS, LLC	CARDARELLI ANGELO	10.369
1111		LATTICE DEVELOPED MARKETS (EX-US) STRATEGY ETF	CARDARELLI ANGELO	3.141
888		LAUDUS INTERNATIONAL MARKETMASTERS FUND	CARDARELLI ANGELO	12.519
889		LAUDUS MONDRIAN INTERNATIONAL EQUITY FUND	CARDARELLI ANGELO	231.732
589		LAWRENCE LIVERMORE NATIONAL SECURITY, LLC AND LOS ALAMOS NATIONAL SECURITY, LLC D	CARDARELLI ANGELO	85.434
840		LAZARD ASSET MANAGEMENT LLC	CARDARELLI ANGELO	214
916		LAZARD ASSET MANAGEMENT LLC	CARDARELLI ANGELO	82
459		LAZARD EUROPEAN ALPHA FUND	CARDARELLI ANGELO	147.906
306		LAZARD EUROPEAN EQUITY FD - LAZARD GLOBAL ACTIVE FUNDS PLC	CARDARELLI ANGELO	89.276
2251		LAZARD FRERES GESTION	CARDARELLI ANGELO	100.750
100		LAZARD GLOBAL EQUITY 130/30 FUND	CARDARELLI ANGELO	52.687
308		LAZARD PAN EUROPEAN EQUITY FD -LAZARD GLOBAL ACTIVE FUNDS PLC	CARDARELLI ANGELO	32.077
818		LBPAM ACTIONS EUROPE DU SUD	CARDARELLI ANGELO	12.805
781		LBPAM ACTIONS INDICE	CARDARELLI ANGELO	85.841
783		LBPAM PROFIL 100	CARDARELLI ANGELO	29.318
782		LBPAM PROFIL 80 PEA	CARDARELLI ANGELO	19.322
167		LCL ACTIONS EURO HAUT RENDEMENT	CARDARELLI ANGELO	17
168		LCL ACTIONS EURO MIN VAR	CARDARELLI ANGELO	13
169		LCL ACTIONS EURO RESTRUCTURAT EURO	CARDARELLI ANGELO	17
170		LCL ACTIONS EURO SELECT	CARDARELLI ANGELO	16
172		LCL ACTIONS EUROPE RESTRUCTURATION	CARDARELLI ANGELO	19
173		LCL ACTIONS EUROPE SELECT	CARDARELLI ANGELO	17
74		LEGAL AND GENERAL COLLECTIVE INVESTMENT TRUST	CARDARELLI ANGELO	142.403

ASSEMBLEA ORDINARIA 12 MAGGIO 2016

Segreteria Societaria - Ufficio Titoli



M...

Unica convocazione

Esito della votazione sul punto 2

Attribuzione dell'utile di esercizio

81607/101

Elenco Favorevoli

SCHEDA	VPC	NOMINATIVO AZIONISTA	DELEGATO	NUMERO DI AZIONI TOTALE
2082		LEGAL & GENERAL AUTHORISED CONTRACTUAL SCHEME	CARDARELLI ANGELO	33.128
1846		LEGAL & GENERAL MSCI EAFE FUND, LLC	CARDARELLI ANGELO	28.574
21		LEGAL AND GENERAL ASSURANCE PENSIONS MANAGEMENT LIMITED	CARDARELLI ANGELO	99.365
31		LEGAL AND GENERAL ASSURANCE PENSIONS MANAGEMENT LIMITED	CARDARELLI ANGELO	17.084.263
2081		LEGAL AND GENERAL AUTHORISED CONTRACTUAL SCHEME	CARDARELLI ANGELO	46.985
864		LEGG MASON DEVELOPED EX-US DIVERSIFIED CORE ETF	CARDARELLI ANGELO	2.035
1710		LEGG MASON FUNDS ICVC-LEGG MASON IF MARTIN CURRIE EU EQ IN FND	CARDARELLI ANGELO	33.954
824		LEGG MASON GLOBAL FUNDS PLC LEGG MASON MARTIN CURRIE GLOBAL RESO	CARDARELLI ANGELO	41.905
50		LEGG MASON INC.	CARDARELLI ANGELO	620
2620		LEMBAGA TABUNG AMANAH PEKERJA	CARDARELLI ANGELO	40.688
103		LEVIN CAPITAL TRILOGY MASTER FUND LTF CO WALKERS SPV LIMITED	CARDARELLI ANGELO	12.500
2667		LEXMARK DYNAMIQUE	CARDARELLI ANGELO	2.000
2508		LHCO FONDS	CARDARELLI ANGELO	30.000
273		LIBERTY BANK	CARDARELLI ANGELO	65.639
1911		LIBERTY MUTUAL EMPLOYEES' THRIFT-INCENTIVE PLAN	CARDARELLI ANGELO	115.769
3234		LIBERTY MUTUAL INSURANCE COMPANY	CARDARELLI ANGELO	126.553
383		LIBERTY MUTUAL RETIREMENT PLAN MASTER TRUST	CARDARELLI ANGELO	225.134
384		LIBERTY MUTUAL RETIREMENT PLAN MASTER TRUST	CARDARELLI ANGELO	114.450
754		LION FLAMME	CARDARELLI ANGELO	49.142
1765		LJR LIMITED PARTNERSHIP	CARDARELLI ANGELO	36.563
1766		LJR LIMITED PARTNERSHIP	CARDARELLI ANGELO	40.491
702		LMCG GLOBAL MULTICAP FUND	CARDARELLI ANGELO	586
241		LOCAL 705 INTERNATIONAL BROTHERHOOD OF TEAMSTERS PENSION FUND	CARDARELLI ANGELO	40.033

M...

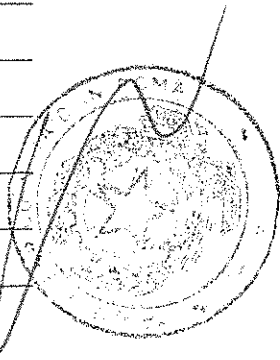

ASSEMBLEA ORDINARIA

81607/402 12 MAGGIO 2016

Segreteria Societaria - Ufficio Titoli



eni

Unica convocazione

Esito della votazione sul punto 2

Attribuzione dell'utile di esercizio

Elenco Favorevoli

SCHEDA	VPC	NOMINATIVO AZIONISTA	DELEGATO	NUMERO DI AZIONI TOTALE
2842		LOCAL INVESTMENT FUND	CARDARELLI ANGELO	18.176
609		LOCAL NO 8 IBEW RETIREMENT PLAN AND TRUST	CARDARELLI ANGELO	37.011
1913		LOCKHEED MARTIN CORP BEN TR FOR COLL BARGAINED EMPL VEBA II	CARDARELLI ANGELO	9.280
1133		LOCKHEED MARTIN CORP DEFINED CONTRIBUTION PLAN MASTER TRUST	CARDARELLI ANGELO	26.506
1970		LOCKHEED MARTIN CORPORATION MASTER RETIREMENT TRUST	CARDARELLI ANGELO	276.807
1971		LOCKHEED MARTIN CORPORATION MASTER RETIREMENT TRUST	CARDARELLI ANGELO	120.000
1972		LOCKHEED MARTIN CORPORATION MASTER RETIREMENT TRUST	CARDARELLI ANGELO	12.367
861		LOCKHEED MARTIN SUPPLEMENTAL EXCESS RETIREMENT TRUST	CARDARELLI ANGELO	3.797
3264		LOMBARD ODIER DARIER HFM SA INSTITUTIONNEL-3D	CARDARELLI ANGELO	322.113
362		LONDON BOROUGH OF CROYDON PENSION FUND	CARDARELLI ANGELO	90.911
1676		LONDON BOROUGH OF TOWER HAMLETS PENSION FUND	CARDARELLI ANGELO	80.188
3167		LONDON LIFE INSURANCE COMPANY	CARDARELLI ANGELO	80.692
3247		LONDON LIFE INSURANCE COMPANY	CARDARELLI ANGELO	55.507
584		LONDON LIFE INSURANCE COMPANY .	CARDARELLI ANGELO	232.192
585		LONDON LIFE INSURANCE COMPANY .	CARDARELLI ANGELO	7.546
586		LONDON LIFE INSURANCE COMPANY .	CARDARELLI ANGELO	342.238
587		LONDON LIFE INSURANCE COMPANY .	CARDARELLI ANGELO	113.174
588		LONDON LIFE INSURANCE COMPANY .	CARDARELLI ANGELO	35.514
1968		LOS ANGELES CITY EMPLOYEES RETIREMENT SYSTEM	CARDARELLI ANGELO	247.790
1969		LOS ANGELES CITY EMPLOYEES RETIREMENT SYSTEM	CARDARELLI ANGELO	538.700
2031		LOTHIAN PENSION FUND	CARDARELLI ANGELO	128.050
2032		LOTHIAN PENSION FUND	CARDARELLI ANGELO	188.085
2033		LOTHIAN PENSION FUND	CARDARELLI ANGELO	835.722

ASSEMBLEA ORDINARIA 12 MAGGIO 2016

Segreteria Societaria - Ufficio Titoli



81607/1103

Smeri

Unica convocazione

Esito della votazione sul punto 2

Attribuzione dell'utile di esercizio

Elenco Favorevoli

SCHEDA	VPC	NOMINATIVO AZIONISTA	DELEGATO	NUMERO DI AZIONI TOTALE
597		LOUISIANA STATE EMPLOYEES' RETIREMENT SYSTEM	CARDARELLI ANGELO	209.800
598		LOUISIANA STATE EMPLOYEES' RETIREMENT SYSTEM	CARDARELLI ANGELO	380.289
1848		LOY PARTNERSHIP, LLC	CARDARELLI ANGELO	9.948
1847		LTW GROUP HOLDINGS, LLC	CARDARELLI ANGELO	37.962
1912		LTW INVESTMENTS LLC	CARDARELLI ANGELO	9.763
582		LUCENT TECHNOLOGIES INC. DEFINED CONTRIBUTION PLAN MASTER TRUST	CARDARELLI ANGELO	184.743
583		LUCENT TECHNOLOGIES INC. DEFINED CONTRIBUTION PLAN MASTER TRUST	CARDARELLI ANGELO	32.554
590		LUCENT TECHNOLOGIES INC. MASTERPENSION TRUST	CARDARELLI ANGELO	42.466
591		LUCENT TECHNOLOGIES INC. MASTERPENSION TRUST	CARDARELLI ANGELO	276.044
2841		LUCRF PTY LTD FOR THE LABOUR UNION CO-O	CARDARELLI ANGELO	29.846
2903		LUCRF PTY LTD FOR THE LABOUR UNION CO-O	CARDARELLI ANGELO	19.571
764		LV CHALLENGE	CARDARELLI ANGELO	23.821
595		LVIP AQR ENHANCED GLOBAL STRATEGIES FUND	CARDARELLI ANGELO	1.070
596		LVIP FRANKLIN TEMPLETON MULTI-ASSET OPPORTUNITIES FUND	CARDARELLI ANGELO	1.747
592		LVIP MONDRIAN INTERNATIONAL VALUE FUND	CARDARELLI ANGELO	1.799.128
594		LVIP SSGA INTERNATIONAL INDEX FUND	CARDARELLI ANGELO	528.647
593		LVIP TEMPLETON GROWTH RPM FUND	CARDARELLI ANGELO	267.576
599		LYONDELLBASELL MASTER TRUST	CARDARELLI ANGELO	40.336
600		LYONDELLBASELL MASTER TRUST	CARDARELLI ANGELO	24.655
1705		M+G INVESTMENT FUNDS (1)- M+G EUROPEAN INDEX TRACKER FUND	CARDARELLI ANGELO	41.066
1706		M+G INVESTMENT FUNDS (7)- M+G GLOBAL CONVERTIBLES FUND	CARDARELLI ANGELO	723.000
1816		MA 94 B SHARES, LP	CARDARELLI ANGELO	21.036
85		MAGNETAR GLOBAL EVENT DRIVEN MASTER FUND LTD COM AND C CORP.SERVICES LIMITED	CARDARELLI ANGELO	1

Smeri

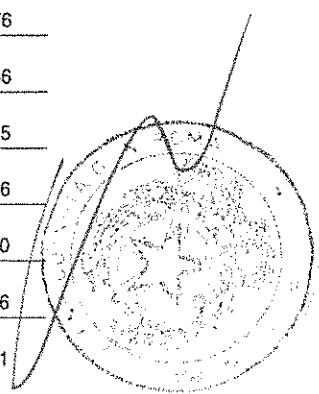

ASSEMBLEA ORDINARIA

81607/1104 12 MAGGIO 2016

Segreteria Societaria - Ufficio Titoli



eni

Unica convocazione

Esito della votazione sul punto 2

Attribuzione dell'utile di esercizio

Elenco Favorevoli

SCHEDA	VPC	NOMINATIVO AZIONISTA	DELEGATO	NUMERO DI AZIONI TOTALE
1651		MAINSTAY 130/30 INTERNATIONAL FUND	CARDARELLI ANGELO	213.735
1665		MANAGED PENSION FUNDS LIMITED	CARDARELLI ANGELO	1.607.278
1666		MANAGED PENSION FUNDS LIMITED	CARDARELLI ANGELO	40.277
1687		MANAGED PENSION FUNDS LIMITED	CARDARELLI ANGELO	746.191
1707		MANAGED PENSION FUNDS LIMITED	CARDARELLI ANGELO	7.108
3157		MANITOBA TELECOM SERV&PARTECIP SUBS EMPL	CARDARELLI ANGELO	48.954
1326		MANULIFE ASSET MANAGEMENT INTERNATIONAL EQUITY INDEX POOLED F	CARDARELLI ANGELO	65.094
3156		MANULIFE GLOBAL ENHANCED EQUITY FUND AQR	CARDARELLI ANGELO	1.793
3159		MANULIFE INTERNATIONAL EQUITY FUND	CARDARELLI ANGELO	439.780
3158		MANULIFE INTERNATIONAL EQUITY INDEX FUND	CARDARELLI ANGELO	11.925
822		MANVILLE PERSONAL INJURY SETTLEMENT TRUST	CARDARELLI ANGELO	15.759
1383		MARCH FUND	CARDARELLI ANGELO	9.991
1384		MARCH FUND	CARDARELLI ANGELO	5.880
1759		MARGARET A. CARGILL FOUNDATION	CARDARELLI ANGELO	47.246
1973		MARSH AND MCLENNAN MASTER RETIREMENT TRUST	CARDARELLI ANGELO	35.085
1974		MARSH AND MCLENNAN MASTER RETIREMENT TRUST	CARDARELLI ANGELO	165.506
1712		MARTIN CURRIE PORTFOLIO INVESTMENT TRUST PLC	CARDARELLI ANGELO	184.199
1915		MARY K MCQUISTON MCCAW	CARDARELLI ANGELO	3.160
1113		MARYLAND STATE RETIREMENT & PENSION SYSTEM	CARDARELLI ANGELO	108.935
1114		MARYLAND STATE RETIREMENT & PENSION SYSTEM	CARDARELLI ANGELO	40.410
1115		MARYLAND STATE RETIREMENT & PENSION SYSTEM	CARDARELLI ANGELO	80.200
1116		MARYLAND STATE RETIREMENT & PENSION SYSTEM	CARDARELLI ANGELO	30.138
1117		MARYLAND STATE RETIREMENT & PENSION SYSTEM	CARDARELLI ANGELO	36.897

ASSEMBLEA ORDINARIA 12 MAGGIO 2016

Segreteria Societaria - Ufficio Titoli



eni

M

Unica convocazione

Esito della votazione sul punto 2

Attribuzione dell'utile di esercizio

81607/1105

Elenco Favorevoli

SCHEDA	VPC	NOMINATIVO AZIONISTA	DELEGATO	NUMERO DI AZIONI TOTALE
1556		MARYLAND STATE RETIREMENT & PENSION SYSTEM CARDARELLI ANGELO		289.362
1557		MARYLAND STATE RETIREMENT & PENSION SYSTEM CARDARELLI ANGELO		224.071
1543		MASSMUTUAL SELECT OVERSEAS FUND CARDARELLI ANGELO		148.673
1472		MASTER INTERNATIONAL INDEX SERIES OF QUANT MASTER SERIES LLC CARDARELLI ANGELO		751.586
1919		MASTER TR AGREE BETWEEN PFIZER INC AND THE NORTHERN TR CO CARDARELLI ANGELO		266.266
1920		MASTER TR AGREE BETWEEN PFIZER INC AND THE NORTHERN TR CO CARDARELLI ANGELO		187.202
1921		MASTER TR AGREE BETWEEN PFIZER INC AND THE NORTHERN TR CO CARDARELLI ANGELO		142.621
1922		MASTER TR AGREE BETWEEN PFIZER INC AND THE NORTHERN TR CO CARDARELLI ANGELO		16.798
1923		MASTER TR AGREE BETWEEN PFIZER INC AND THE NORTHERN TR CO CARDARELLI ANGELO		284.543
2981		MASTER TRUST BANK OF JAPAN, LTD. PENSION CARDARELLI ANGELO		3.069.523
1477		MASTER TRUST FOR CERTAIN TAX-QUAL BECHTEL RETIREMENT PLANS CARDARELLI ANGELO		90.756
3088		MASTER TRUST FOR NATIONAL PENSION FD CARDARELLI ANGELO		46.760
3134		MASTER TRUST FOR SIEMENS PENSION PLANS CARDARELLI ANGELO		54.601
3135		MASTER TRUST FOR SIEMENS SAVINGS PLANS CARDARELLI ANGELO		121.547
292		MAXIM INTERNATIONAL INDEX PORTFOLIO OF MAXIM SERIES FUND, INC CARDARELLI ANGELO		162.097
226		MAXIM MFS INTERNATIONAL GROWTH PORTFOLIO CARDARELLI ANGELO		138.014
608		MCGILL UNIVERSITY PENSION FUND CARDARELLI ANGELO		8.812
1122		MD EQUITY FUND CARDARELLI ANGELO		114.049
1121		MD INTERNATIONAL VALUE FUND CARDARELLI ANGELO		96.030
1123		MDPIM INTERNATIONAL EQUITY POOL CARDARELLI ANGELO		776.029
263		MENNONITE EDUCATION AGENCY INC CARDARELLI ANGELO		14.167
1126		MERCER GLOBAL EQUITY FUND CARDARELLI ANGELO		16.814
1539		MERCER NON-US CORE EQUITY FUND CARDARELLI ANGELO		91.399

M

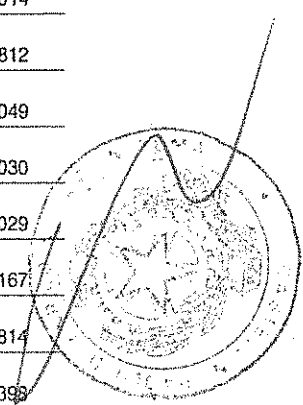

ASSEMBLEA ORDINARIA

81607/406 12 MAGGIO 2016

Segreteria Societaria - Ufficio Titoli



eni

Unica convocazione

Esito della votazione sul punto 2

Attribuzione dell'utile di esercizio

Elenco Favorevoli

SCHEDA	VPC	NOMINATIVO AZIONISTA	DELEGATO	NUMERO DI AZIONI TOTALE
2016		MERCER OSS TRUST	CARDARELLI ANGELO	15.932
2015		MERCER PASSIVE INTERNATIONAL SHARES FUND	CARDARELLI ANGELO	66.355
1125		MERCER QIF CCF	CARDARELLI ANGELO	88.051
1128		MERCER QIF CCF	CARDARELLI ANGELO	239.855
1129		MERCER QIF CCF	CARDARELLI ANGELO	456.366
1131		MERCER QIF CCF	CARDARELLI ANGELO	850.664
1132		MERCER QIF CCF	CARDARELLI ANGELO	471.025
449		MERCK AND CO., INC MASTER RETIREMENT TRUST	CARDARELLI ANGELO	80.458
450		MERCK AND CO., INC MASTER RETIREMENT TRUST	CARDARELLI ANGELO	30.959
1255		MERCK CAPITAL ASSET MANAGEMENT LIMITED	CARDARELLI ANGELO	87.582
1522		MERCY HEALTH	CARDARELLI ANGELO	50.721
1588		MERCY HEALTH RETIREMENT TRUST	CARDARELLI ANGELO	11.743
611		MERCY INVESTMENT SERVICES	CARDARELLI ANGELO	22.747
401		MERRIAM FINANCIAL SERVICES, LTD	CARDARELLI ANGELO	15.496
2355		MERRILL LYNCH PROFESSIONAL CLEARING CORP	CARDARELLI ANGELO	240.958
2038		MERSEYSIDE PENSION FUND	CARDARELLI ANGELO	100.000
991		MET INVESTOR SERIES TRUST-ALLIANC GLOBAL DYNAMIC ALL PTF	CARDARELLI ANGELO	244.876
1513		MET INVESTOR SERIES TRUST-MFS RESEARCH INTERNATIONAL PTF	CARDARELLI ANGELO	1.152.686
993		MET INVESTORS SERIES TRUST- JPMORGAN GLOBAL ACTIVE ALL PTF	CARDARELLI ANGELO	30.888
992		MET INVESTORS SERIES TRUST- SCHRODERS GLOBAL MULTI-ASSET PTF	CARDARELLI ANGELO	117.276
338		METAL INDUSTRIES PROVIDENT FUND	CARDARELLI ANGELO	158.100
2268		METROPOLE GESTION	CARDARELLI ANGELO	129.000
2267		METROPOLE VALUE SRI	CARDARELLI ANGELO	37.000

ASSEMBLEA ORDINARIA 12 MAGGIO 2016

Segreteria Societaria - Ufficio Titoli



M...

81607/1107

Unica convocazione

Esito della votazione sul punto 2

Attribuzione dell'utile di esercizio

Elenco Favorevoli

SCHEDA	VPC	NOMINATIVO AZIONISTA	DELEGATO	NUMERO DI AZIONI TOTALE
886		METROPOLITAN LIFE INSURANCE COMPANY	CARDARELLI ANGELO	9.598
940		METROPOLITAN LIFE INSURANCE COMPANY	CARDARELLI ANGELO	43.342
941		METROPOLITAN LIFE INSURANCE COMPANY	CARDARELLI ANGELO	102.951
2603		METROPOLITAN RENTASTRO	CARDARELLI ANGELO	213.987
1530		METROPOLITAN SERIES FUND- MSCI EAFE INDEX PORTFOLIO	CARDARELLI ANGELO	199.268
613		METROPOLITAN WATER RECLAMATION DISTRICT RETIREMENT FUND	CARDARELLI ANGELO	10.117
1259		METZLER INVESTMENT GMBH FOR MI-FONDS 415	CARDARELLI ANGELO	21.650
1260		METZLER INVESTMENT GMBH FOR MI-FONDS 415	CARDARELLI ANGELO	46.981
1261		METZLER INVESTMENT GMBH FOR MI-FONDS 415	CARDARELLI ANGELO	164.762
1262		METZLER INVESTMENT GMBH FOR MI-FONDS 415	CARDARELLI ANGELO	130.093
2235		METZLER STRATEGIC INVEST	CARDARELLI ANGELO	3.379
922		MFS BLENDED RESEARCH INTERNATIONAL EQUITIES FUND	CARDARELLI ANGELO	2.556
919		MFS DEVELOPMENT FUNDS, LLC	CARDARELLI ANGELO	1.038
3101		MFS GLOBAL ALTERNATIVE STRATEGY FUND	CARDARELLI ANGELO	17.834
920		MFS HERITAGE TRUST COMPANY COLLECTIVE INVESTMENT TRUST	CARDARELLI ANGELO	136.459
921		MFS HERITAGE TRUST COMPANY COLLECTIVE INVESTMENT TRUST	CARDARELLI ANGELO	87.327
2933		MFS INSTITUTIONAL INTERNATIONAL EQUITY F	CARDARELLI ANGELO	3.320.663
3155		MFS INTERNATIONAL EQUITY FUND	CARDARELLI ANGELO	144.922
1030		MFS INTERNATIONAL EQUITY FUND II	CARDARELLI ANGELO	566.588
3115		MFS INTERNATIONAL RESEARCH EQUITY LLC	CARDARELLI ANGELO	23.527
1380		MFS MERIDIAN FUNDS	CARDARELLI ANGELO	1.870.106
1381		MFS MERIDIAN FUNDS	CARDARELLI ANGELO	3.950
1382		MFS MERIDIAN FUNDS	CARDARELLI ANGELO	75.852

M...

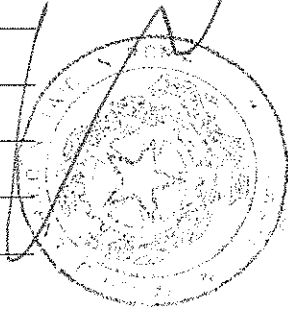

ASSEMBLEA ORDINARIA

81607/1108 12 MAGGIO 2016

Segreteria Societaria - Ufficio Titoli



eni

Unica convocazione

Esito della votazione sul punto 2

Attribuzione dell'utile di esercizio

Elenco Favorevoli

SCHEDA	VPC	NOMINATIVO AZIONISTA	DELEGATO	NUMERO DI AZIONI TOTALE
2239		MFS RESEARCH INTERNATIONAL FDP	CARDARELLI ANGELO	96.699
1493		MFS RESEARCH INTERNATIONAL FUND	CARDARELLI ANGELO	4.072.326
1494		MFS VARIABLE INSURANCE TRUST II - MFS RESEARCH INT PORTFOLIO	CARDARELLI ANGELO	259.894
1124		MGI FUNDS PLC	CARDARELLI ANGELO	14.486
1127		MGI FUNDS PLC	CARDARELLI ANGELO	69.619
3030		MI-FONDS 368	CARDARELLI ANGELO	83.413
3032		MI-FONDS 391	CARDARELLI ANGELO	19.089
3031		MI-FONDS 392	CARDARELLI ANGELO	43.745
421		MI-FONDS K10	CARDARELLI ANGELO	54.837
422		MI-FONDS K12	CARDARELLI ANGELO	46.355
1814		MICHIGAN CATHOLIC CONFERENCE	CARDARELLI ANGELO	2.947
1767		MICHIGAN CATHOLIC CONFERENCE MASTER PENSION TRUST	CARDARELLI ANGELO	14.038
1024		MICROSOFT CORPORATION SAVINGS PLUS 401(K) PLAN	CARDARELLI ANGELO	142.600
1025		MICROSOFT CORPORATION SAVINGS PLUS 401(K) PLAN	CARDARELLI ANGELO	230.832
1026		MICROSOFT CORPORATION SAVINGS PLUS 401(K) PLAN	CARDARELLI ANGELO	145.866
331		MILLIKEN (AND) COMPANY	CARDARELLI ANGELO	9.737
3210		MINISTRY OF FINANCE - BAHREIN	CARDARELLI ANGELO	42.666
396		MINISTRY OF FINANCE OF THE REPUBLIC OF KAZAKHST	CARDARELLI ANGELO	259.146
397		MINISTRY OF FINANCE OF THE REPUBLIC OF KAZAKHST	CARDARELLI ANGELO	53.056
398		MINISTRY OF FINANCE OF THE REPUBLIC OF KAZAKHST	CARDARELLI ANGELO	39.099
1202		MINISTRY OF STRATEGY AND FINANCE	CARDARELLI ANGELO	17.881
1203		MINISTRY OF STRATEGY AND FINANCE	CARDARELLI ANGELO	1.558
1215		MINISTRY OF STRATEGY AND FINANCE	CARDARELLI ANGELO	67.289

ASSEMBLEA ORDINARIA 12 MAGGIO 2016

Segreteria Societaria - Ufficio Titoli

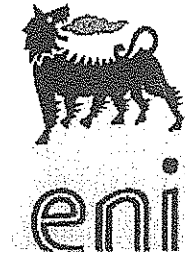

Mancini

81607/1109

Unica convocazione

Esito della votazione sul punto 2

Attribuzione dell'utile di esercizio

Elenco Favorevoli

SCHEDA	VPC	NOMINATIVO AZIONISTA	DELEGATO	NUMERO DI AZIONI TOTALE
1217		MINISTRY OF STRATEGY AND FINANCE	CARDARELLI ANGELO	143.710
1218		MINISTRY OF STRATEGY AND FINANCE	CARDARELLI ANGELO	77.121
1222		MINISTRY OF STRATEGY AND FINANCE	CARDARELLI ANGELO	143.003
466		MINNESOTA LIFE INSURANCE COMPANY	CARDARELLI ANGELO	28.837
1231		MINNESOTA LIFE INSURANCE COMPANY	CARDARELLI ANGELO	27.666
3076		MISSOURI EDUCATION PENSION TRUST	CARDARELLI ANGELO	57.871
3077		MISSOURI EDUCATION PENSION TRUST	CARDARELLI ANGELO	309.503
261		MLC LIMITED	CARDARELLI ANGELO	915
262		MLC LIMITED	CARDARELLI ANGELO	3.526
1078		MM MSCI EAFE INTERNATIONAL INDEX FUND	CARDARELLI ANGELO	92.756
1544		MML FOREIGN FUND	CARDARELLI ANGELO	322.850
2425		MONDRIAN ALL COUNTRIES WORLD EX-U.S	CARDARELLI ANGELO	275.388
1850		MONDRIAN ALL COUNTRIES WORLD EX-US EQUITY FUND LP	CARDARELLI ANGELO	1.658.178
2066		MONDRIAN FUNDS PUBLIC LIMITED COMPANY	CARDARELLI ANGELO	2.124
1849		MONDRIAN GLOBAL EQUITY FUND, L.P.	CARDARELLI ANGELO	210.330
1914		MONDRIAN GROUP TRUST	CARDARELLI ANGELO	624.072
1805		MONDRIAN INTERNATIONAL EQUITY FUND L.P.	CARDARELLI ANGELO	6.036.111
1407		MONETARY AUTHORITY OF SINGAPORE	CARDARELLI ANGELO	488.200
1644		MONETARY AUTHORITY OF SINGAPORE	CARDARELLI ANGELO	82.250
1652		MONETARY AUTHORITY OF SINGAPORE FUND	CARDARELLI ANGELO	252.408
1916		MONSANTO COMP DEFINED CONTRIB AND EMPLOYEE STOCK OWNERSHIP TR	CARDARELLI ANGELO	66.306
1791		MONSANTO COMPANY MASTER PENSION TRUST	CARDARELLI ANGELO	86.422
2498		MONTJOLY INVESTISSEMENT	CARDARELLI ANGELO	8.450

Mancini

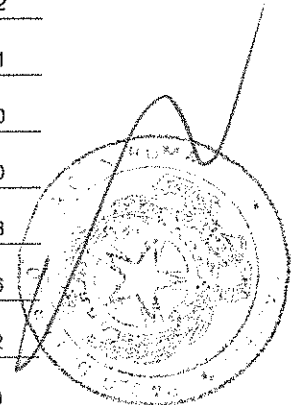

ASSEMBLEA ORDINARIA

81607/1110 12 MAGGIO 2016

Segreteria Societaria - Ufficio Titoli



eni

Unica convocazione

Esito della votazione sul punto 2

Attribuzione dell'utile di esercizio

Elenco Favorevoli

SCHEDA	VPC	NOMINATIVO AZIONISTA	DELEGATO	NUMERO DI AZIONI TOTALE
1559		MORGAN STANLEY INST F INC - ACTIVE INT ALLOCATION PTF	CARDARELLI ANGELO	12.598
1561		MORGAN STANLEY INSTITUTIONAL FD TR - GLOBAL STRATEGIST PTF	CARDARELLI ANGELO	22.322
1130		MORGAN STANLEY INSTITUTIONAL FUND TR- GL MULTI-ASSET INC PTF	CARDARELLI ANGELO	1.122
1560		MORGAN STANLEY INSTITUTIONAL FUND, INC. - INT EQ PTF	CARDARELLI ANGELO	1.131.679
1558		MORGAN STANLEY INTERNATIONAL EQUITY FUND	CARDARELLI ANGELO	57.022
1156		MORGAN STANLEY INV MGMT INT EQ TRUST II	CARDARELLI ANGELO	63.827
2760		MORGAN STANLEY INVESTMENT FUNDS	CARDARELLI ANGELO	1.428.304
2780		MORGAN STANLEY INVESTMENT FUNDS	CARDARELLI ANGELO	1.226
2782		MORGAN STANLEY INVESTMENT FUNDS	CARDARELLI ANGELO	18.680
2783		MORGAN STANLEY INVESTMENT FUNDS	CARDARELLI ANGELO	16.061
1571		MORGAN STANLEY INVESTMENT MANAGEMENT INT EQUITY TRUST	CARDARELLI ANGELO	587.344
1563		MORGAN STANLEY OFFSHORE INTERNATIONAL EQUITY FUND	CARDARELLI ANGELO	82.210
1860		MS FUND LP	CARDARELLI ANGELO	45.589
1800		MS TR AGREE UN VAR EMPL BEN PL UNIL US INC & ITS SUB & AFF	CARDARELLI ANGELO	1.964
1342		MSCI EAFE PROV SCREENED INDEX NON - LENDING COMMON TR FUND	CARDARELLI ANGELO	24.088
1458		MSCI EQUITY INDEX FUND B-ITALY	CARDARELLI ANGELO	1.118.315
239		MT TOTAL RETURN FUND	CARDARELLI ANGELO	7.674
2911		MTBJ DAIDO LIFE FOREIGN EQUITY MOTHER FD	CARDARELLI ANGELO	2.780
1097		MULTI-STYLE, MULTI-MANAGER FUNDS PLC	CARDARELLI ANGELO	61.088
1552		MULTI-STYLE, MULTI-MANAGER FUNDS PLC	CARDARELLI ANGELO	185.000
2626		MULTIMIX WHOLESALE INT SHARES TRUST	CARDARELLI ANGELO	151.734
73		MUNDER INTERNATIONAL FUND CORE EQUITY	CARDARELLI ANGELO	4.205
2055		MUNICIPAL EMPLOYEES' ANNUITY AND BENEFIT FUND OF CHICAGO	CARDARELLI ANGELO	39.887

ASSEMBLEA ORDINARIA 12 MAGGIO 2016

Segreteria Societaria - Ufficio Titoli



Murray

Unica convocazione

Esito della votazione sul punto 2

Attribuzione dell'utile di esercizio

81607/111

Elenco Favorevoli

SCHEDA	VPC	NOMINATIVO AZIONISTA	DELEGATO	NUMERO DI AZIONI TOTALE
351		MURRAY INTERNATIONAL TRUST PLC	CARDARELLI ANGELO	1.870.000
2627		Mercer Unhedged Overseas Shares Trust	CARDARELLI ANGELO	8.261
760		N 1 RENDEMENT USINOR	CARDARELLI ANGELO	8.471
2437		NADAUD	CARDARELLI ANGELO	21.793
2056		NAT WEST BANK PLC AS TRUSTEE OF LEG & GEN GLOBAL EOT IND FD	CARDARELLI ANGELO	4.128
2057		NAT WEST BK AS TRUSTEE OF LEGAL & GENERAL EUROPEAN INDEX TR	CARDARELLI ANGELO	1.495.453
2058		NAT WEST BK PLC AS TRUSTEE OF THE LEGAL & GENERAL INT IND TR	CARDARELLI ANGELO	72.805
1645		NAT WESTM BK PLC ATF THE PRUD QUAL INV SC UM UT- PRUD E QIS F	CARDARELLI ANGELO	641.525
1868		NATIONAL COUNCIL FOR SOCIAL SECURITY FUND, P.R.C	CARDARELLI ANGELO	28.761
1869		NATIONAL COUNCIL FOR SOCIAL SECURITY FUND, P.R.C	CARDARELLI ANGELO	21.253
1870		NATIONAL COUNCIL FOR SOCIAL SECURITY FUND, P.R.C	CARDARELLI ANGELO	34.694
1871		NATIONAL COUNCIL FOR SOCIAL SECURITY FUND, P.R.C	CARDARELLI ANGELO	66.000
1872		NATIONAL COUNCIL FOR SOCIAL SECURITY FUND, P.R.C	CARDARELLI ANGELO	117.966
1873		NATIONAL COUNCIL FOR SOCIAL SECURITY FUND, P.R.C	CARDARELLI ANGELO	139.147
1874		NATIONAL COUNCIL FOR SOCIAL SECURITY FUND, P.R.C	CARDARELLI ANGELO	108.800
1875		NATIONAL COUNCIL FOR SOCIAL SECURITY FUND, P.R.C	CARDARELLI ANGELO	119.477
1876		NATIONAL COUNCIL FOR SOCIAL SECURITY FUND, P.R.C	CARDARELLI ANGELO	230.954
48		NATIONAL COUNCIL FOR SOCIAL SECURITY FUND.	CARDARELLI ANGELO	22.615
408		NATIONAL TREASURY MANAGEMENT AGENCY (AS CONTROLLER AND MANAGER OF THE IRELAND ST	CARDARELLI ANGELO	250.913
1711		NATIONAL TRUST FOR SCOTLAND	CARDARELLI ANGELO	38.902
2003		NATIONAL WESTMINSTER BANK PLC AS TR OF JUPITER ABS RETURN F	CARDARELLI ANGELO	100.000
2002		NATIONAL WESTMINSTER BANK PLC AS TR OF JUPITER EUROP INC F	CARDARELLI ANGELO	111.282
2013		NATIONAL WESTMINSTER BANK PLC AS TRUSTEE OF KES STRAT INV F	CARDARELLI ANGELO	17.526

Murray

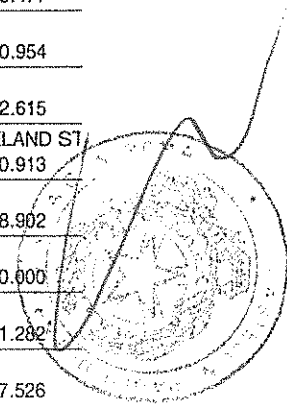

ASSEMBLEA ORDINARIA

81607/412 12 MAGGIO 2016

Segreteria Societaria - Ufficio Titoli



eni

Unica convocazione

Esito della votazione sul punto 2

Attribuzione dell'utile di esercizio

Elenco Favorevoli

SCHEDA	VPC	NOMINATIVO AZIONISTA	DELEGATO	NUMERO DI AZIONI TOTALE
1752		NATIONAL WESTMINSTER BK PLC AS TR OF BARING TARGETED RETURN F	CARDARELLI ANGELO	18.008
2916		NATIONAL WESTMINSTER REAL RETURN JP MORGAN FUND FINSBURY	CARDARELLI ANGELO	1.036
3038		NATIONWIDE INTERNATIONAL INDEX FUND	CARDARELLI ANGELO	364.739
2248		NATIXIS AM	CARDARELLI ANGELO	114.496
56		NATWEST OLD MUTUAL HENDRSON EURO FD LTD	CARDARELLI ANGELO	78.420
1995		NAV CANADA PENSION PLAN	CARDARELLI ANGELO	7.504
2481		NAVARRRE INVESTISSEMENT	CARDARELLI ANGELO	5.323
1976		NAVISTAR, INC. RETIREE HEALTH BENEFIT TRUST	CARDARELLI ANGELO	19.173
1554		NEBRASKA PUBLIC EMPLOYEES RETIREMENT SYSTEMS	CARDARELLI ANGELO	295.746
2245		NESTLE FRANCE EQUILIBRE	CARDARELLI ANGELO	14.887
1483		NEW ENGLANDTEAMSTERS AND TRUCKING INDUSTRY PENSION PLAN	CARDARELLI ANGELO	87.321
2004		NEW IRELAND ASSURANCE COMPANY PLC	CARDARELLI ANGELO	163.406
2005		NEW IRELAND ASSURANCE COMPANY PLC	CARDARELLI ANGELO	8.837
2006		NEW IRELAND ASSURANCE COMPANY PLC	CARDARELLI ANGELO	16.882
2007		NEW IRELAND ASSURANCE COMPANY PLC	CARDARELLI ANGELO	53.894
2008		NEW IRELAND ASSURANCE COMPANY PLC	CARDARELLI ANGELO	564.930
2009		NEW IRELAND ASSURANCE COMPANY PLC	CARDARELLI ANGELO	11.101
2010		NEW IRELAND ASSURANCE COMPANY PLC	CARDARELLI ANGELO	99.421
2011		NEW IRELAND ASSURANCE COMPANY PLC	CARDARELLI ANGELO	147.457
2012		NEW IRELAND ASSURANCE COMPANY PLC	CARDARELLI ANGELO	237.000
2021		NEW IRELAND SUPERANNUATION FUND	CARDARELLI ANGELO	90.559
3044		NEW MEXICO STATE INVESTMENT COUNCIL	CARDARELLI ANGELO	120.699
1144		NEW SHIPS, INC. PENSION MASTER TRUST	CARDARELLI ANGELO	31.107

ASSEMBLEA ORDINARIA 12 MAGGIO 2016

Segreteria Societaria - Ufficio Titoli



Man

81607/1113

Unica convocazione

Esito della votazione sul punto 2

Attribuzione dell'utile di esercizio

Elenco Favorevoli

SCHEDA	VPC	NOMINATIVO AZIONISTA	DELEGATO	NUMERO DI AZIONI TOTALE
2913		NEW WORLD FUND, INC	CARDARELLI ANGELO	780.000
3078		NEW YORK STATE COMMON RETIREMENT FUND	CARDARELLI ANGELO	63.300
3079		NEW YORK STATE COMMON RETIREMENT FUND	CARDARELLI ANGELO	473.762
1142		NEW YORK STATE DEFERRED COMPENSATION PLAN	CARDARELLI ANGELO	76.746
1318		NEW YORK STATE TEACHERS RETIREMENT SYSTEM	CARDARELLI ANGELO	1.073.739
1319		NEW YORK STATE TEACHERS RETIREMENT SYSTEM	CARDARELLI ANGELO	40.747
1320		NEW YORK STATE TEACHERS RETIREMENT SYSTEM	CARDARELLI ANGELO	19.414
1887		NEW ZEALAND SUPERANNUATION FUND	CARDARELLI ANGELO	185.631
1888		NEW ZEALAND SUPERANNUATION FUND	CARDARELLI ANGELO	109.183
1889		NEW ZEALAND SUPERANNUATION FUND	CARDARELLI ANGELO	208.753
1379		NEXTAM PARTNERS	CARDARELLI ANGELO	2.801
527		NEXTERA ENERGY DUANE ARNOLD LLCNQ DECOMMISSIONING TRUST	CARDARELLI ANGELO	3.602
528		NEXTERA ENERGY DUANE ARNOLD LLCNQ DECOMMISSIONING TRUST	CARDARELLI ANGELO	4.231
2801		NFS LIMITED	CARDARELLI ANGELO	162.284
2803		NFS LIMITED	CARDARELLI ANGELO	95.624
2804		NFS LIMITED	CARDARELLI ANGELO	110.274
1714		NGAM INVESTMENT FUNDS U.K. ICVC - SEEYOND FACT + EU EX UK EQF	CARDARELLI ANGELO	3.246
1768		NGEE ANN POLYTECHNIC	CARDARELLI ANGELO	1.027
622		NINE MILE POINT NDT QUALIFIED PARTNERSHIP	CARDARELLI ANGELO	27.000
1793		NISSAN NORTH AMERICA, INC. EMPLOYEE RETIREMENT PL MSTR TRUST	CARDARELLI ANGELO	5.970
2352		NMM5 GHDE SCH ACCOUNT	CARDARELLI ANGELO	433.320
2379		NN (L)	CARDARELLI ANGELO	713.521
341		NN PARAPLUFONDS 1 N.V.	CARDARELLI ANGELO	495.411

Man

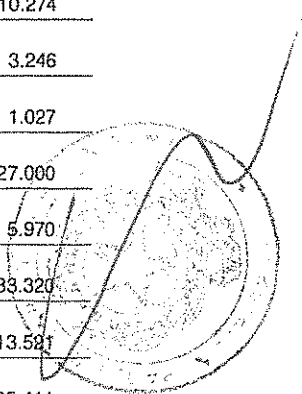

ASSEMBLEA ORDINARIA

81607/114

12 MAGGIO 2016

Segreteria Societaria - Ufficio Titoli



eni

Unica convocazione

Esito della votazione sul punto 2

Attribuzione dell'utile di esercizio

Elenco Favorevoli

SCHEDA	VPC	NOMINATIVO AZIONISTA	DELEGATO	NUMERO DI AZIONI TOTALE
2732		NOMURA TRUST BANKING TRUSTEE NIKKO GLOBA	CARDARELLI ANGELO	175.520
1594		NORFOLK COUNTY RETIREMENT SYSTEM	CARDARELLI ANGELO	26.558
96		NORGES BANK	CARDARELLI ANGELO	1.679.855
1917		NORTHERN FUNDS - INTERNATIONAL EQUITY INDEX FUND	CARDARELLI ANGELO	888.776
1925		NORTHERN TRUST GLOBAL INVESTMENTS COLLECTIVE FUNDS TRUST	CARDARELLI ANGELO	3.712.772
1980		NORTHERN TRUST GLOBAL INVESTMENTS COLLECTIVE FUNDS TRUST	CARDARELLI ANGELO	105.773
1981		NORTHERN TRUST GLOBAL INVESTMENTS COLLECTIVE FUNDS TRUST	CARDARELLI ANGELO	872.033
1982		NORTHERN TRUST GLOBAL INVESTMENTS COLLECTIVE FUNDS TRUST	CARDARELLI ANGELO	333.849
2070		NORTHERN TRUST INVESTMENT FUNDS PUBLIC LIMITED COMPANY	CARDARELLI ANGELO	198.933
1851		NORTHERN TRUST MULTI-ADVISOR FUNDS	CARDARELLI ANGELO	32.963
2039		NORTHERN TRUST UCITS COMMON CONTRACTUAL FUND	CARDARELLI ANGELO	71.773
2040		NORTHERN TRUST UCITS COMMON CONTRACTUAL FUND	CARDARELLI ANGELO	549.870
2041		NORTHERN TRUST UCITS COMMON CONTRACTUAL FUND	CARDARELLI ANGELO	16.838
2097		NORTHERN TRUST UCITS FGR FUND	CARDARELLI ANGELO	417.541
1138		NORTHROP GRUMMAN CORPORATION VEBA MASTER TRUST I	CARDARELLI ANGELO	6.105
230		NORTHWEST NATURAL GAS COMPANY RETIREMENT TRUST	CARDARELLI ANGELO	38.629
2237		NORTHWESTERN MUTUAL SERIES F	CARDARELLI ANGELO	1.116.505
2240		NORTHWESTERN MUTUAL SERIES F	CARDARELLI ANGELO	311.884
2348		NOTENSTEIN SUSTAINABLE BALANCED ALLOCATION CHF	CARDARELLI ANGELO	5.000
1681		NOTTINGHAMSHIRE COUNTY COUNCIL PENSION FUND	CARDARELLI ANGELO	237.905
1682		NOTTINGHAMSHIRE COUNTY COUNCIL PENSION FUND	CARDARELLI ANGELO	157.102
862		NOVARTIS CORPORATION PENSION MASTER TRUST	CARDARELLI ANGELO	36.596
1975		NT UNIT TRUST	CARDARELLI ANGELO	274.930

ASSEMBLEA ORDINARIA 12 MAGGIO 2016

Segreteria Societaria - Ufficio Titoli



eni

81607/115

Unica convocazione

Esito della votazione sul punto 2

Attribuzione dell'utile di esercizio

Elenco Favorevoli

SCHEDA	VPC	NOMINATIVO AZIONISTA	DELEGATO	NUMERO DI AZIONI TOTALE
1771		NTCC COLLECTIVE FUNDS FOR EMPLOYEE BENEFIT TRUSTS CARDARELLI ANGELO		73.421
1795		NTCC COLLECTIVE FUNDS FOR EMPLOYEE BENEFIT TRUSTS CARDARELLI ANGELO		78.607
1867		NTCC COLLECTIVE FUNDS FOR GRANTOR TRUSTS CARDARELLI ANGELO		19.787
1794		NTGI - QM COMM DAILY ALL COUNTRY WD EX-US EQ INDEX F - LEND CARDARELLI ANGELO		105.143
1770		NTGI-QM COMMON DAILY ALL COUNWD EX-US INV MKT INDEX F NONLEND CARDARELLI ANGELO		80.019
1792		NTGI-QM COMMON DAILY EAFE INDEX FUND - LENDING CARDARELLI ANGELO		184.499
1764		NTGI-QM COMMON DAILY EAFE INDEX FUND - NON LENDING CARDARELLI ANGELO		189.087
1824		NUCLEAR ELECTRIC INSURANCE LIMITED CARDARELLI ANGELO		408.956
353		NUCLEAR LIABILITIES FUND LIMITED CARDARELLI ANGELO		61.892
102		NUMERIC INVESTORS LLC CARDARELLI ANGELO		780.890
2278		NUMERIC INVESTORS LLC CARDARELLI ANGELO		85.240
2934		NVIT INTERNATIONAL INDEX FUND CARDARELLI ANGELO		378.506
3131		O'SHARES FTSE EUROPE QUALITY DIVIDEND ET CARDARELLI ANGELO		21.919
2350		ODDO ET CIE CARDARELLI ANGELO		97.955
2810		ODDO MERITEN ASSET MAN.GMBH WIEHEN FONDS CARDARELLI ANGELO		18.880
1523		OFFICEMAX MASTER TRUST CARDARELLI ANGELO		54.396
414		OHRA ZIEKTEKOSTENVERZEKERINGEN N.V CARDARELLI ANGELO		30.260
463		OIL CASUALTY INVESTMENT CORPORATION LTD CARDARELLI ANGELO		85.120
464		OIL CASUALTY INVESTMENT CORPORATION LTD CARDARELLI ANGELO		290.900
944		OKLAHOMA FIREFIGHTERS PENSION & RETIREMENT SYSTEM CARDARELLI ANGELO		110.163
1828		OKLAHOMA PUBLIC EMPLOYEES RETIREMENT SYSTEM CARDARELLI ANGELO		605.219
535		OLD WESTBURY (CAYMAN) FUNDS SPC-OW (CAYMAN) LARGE CAP CORE SP CARDARELLI ANGELO		21.345
340		OLD WESTBURY LARGE CAP CORE FUND CARDARELLI ANGELO		1.029.070

Handwritten signature

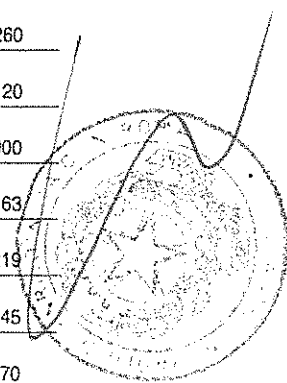

ASSEMBLEA ORDINARIA

81607/146 12 MAGGIO 2016

Segreteria Societaria - Ufficio Titoli



eni

Unica convocazione

Esito della votazione sul punto 2

Attribuzione dell'utile di esercizio

Elenco Favorevoli

SCHEDA	VPC	NOMINATIVO AZIONISTA	DELEGATO	NUMERO DI AZIONI TOTALE
1655		OMERS ADMINISTRATION CORPORATION	CARDARELLI ANGELO	21.166
2880		ONEPATH GLOBAL SHARES LARGE CAP UNHEDGED	CARDARELLI ANGELO	208.236
2861		ONEPATH LOW VOLATILITY GLOBAL EQUITY INDEX POOL	CARDARELLI ANGELO	16.020
523		ONTARIO POWER GENERATION INC.	CARDARELLI ANGELO	105.303
695		ONTARIO POWER GENERATION INC.	CARDARELLI ANGELO	123.951
633		ONTARIO POWER GENERATION INC. PENSION PLAN	CARDARELLI ANGELO	49.603
634		ONTARIO POWER GENERATION INC. PENSION PLAN	CARDARELLI ANGELO	314.681
1143		ONTARIO TEACHERS PENSION PLAN BOARD	CARDARELLI ANGELO	1.441.998
1565		ONTARIO TEACHERS PENSION PLAN BOARD	CARDARELLI ANGELO	744.708
174		OPCVM SEEYOND EQUITY FACTOR INVESTING EURO	CARDARELLI ANGELO	14.762
412		OPEC FUND FOR INTERNATIONAL DEVELOPMENT	CARDARELLI ANGELO	124.921
632		OPERATING ENGINEERS LOCAL 101 PENSION FUND	CARDARELLI ANGELO	50.244
1883		OPSEU PENSION PLAN TRUST FUND	CARDARELLI ANGELO	19.759
1095		ORANGE COUNTY EMPLOYEES RETIREMENT SYSTEM	CARDARELLI ANGELO	139.989
1548		ORANGE COUNTY EMPLOYEES RETIREMENT SYSTEM	CARDARELLI ANGELO	29.581
1496		OREGON PUBLIC EMPLOYEES RETIREMENT SYSTEM	CARDARELLI ANGELO	1.491.902
2043		OVERSTONE COMMON CONTRACTUAL FUND	CARDARELLI ANGELO	941.392
2050		OVERSTONE FUND PLC	CARDARELLI ANGELO	41.294
2051		OVERSTONE FUND PLC	CARDARELLI ANGELO	1.922.425
2052		OVERSTONE FUND PLC	CARDARELLI ANGELO	4.283
2053		OVERSTONE FUND PLC	CARDARELLI ANGELO	3.263
2054		OVERSTONE FUND PLC	CARDARELLI ANGELO	58.333
3111		OWENS CORNING DEFINED BENEFIT MASTER TRU	CARDARELLI ANGELO	5.249

ASSEMBLEA ORDINARIA 12 MAGGIO 2016

Segreteria Societaria - Ufficio Titoli



eni

Unica convocazione

Esito della votazione sul punto 2

Attribuzione dell'utile di esercizio

8160/117

Elenco Favorevoli

SCHEDA VPC	NOMINATIVO AZIONISTA	DELEGATO	NUMERO DI AZIONI TOTALE
876	P.H. GLATFELTER COMPANY MASTER RETIREMENT TRUST	CARDARELLI ANGELO	30.160
1515	PACE INTERNATIONAL EQUITY INVESTMENTS	CARDARELLI ANGELO	217.441
1516	PACE INTERNATIONAL EQUITY INVESTMENTS	CARDARELLI ANGELO	616.111
1650	PACE INTERNATIONAL EQUITY INVESTMENTS	CARDARELLI ANGELO	44.838
415	PACER AUTOPILOT HEDGED EUROPEANINDEX ET	CARDARELLI ANGELO	1.728
717	PACIFIC GAS AND ELECTRIC QUALIFIED CPUC DECOMMISSIONING TRUST	CARDARELLI ANGELO	78.295
1572	PACIFIC SELECT FUND INTERNATIONAL LARGE CAP PORTFOLIO	CARDARELLI ANGELO	938.730
726	PANAGORA ASSET MANAGEMENT INC.	CARDARELLI ANGELO	1.284
727	PANAGORA ASSET MANAGEMENT INC.	CARDARELLI ANGELO	917
17	PANAGORA DIVERSIFIED ARBITRAGE MASTER FUND LTD	CARDARELLI ANGELO	4.147
427	PANAGORA DIVERSIFIED RISK MULTI-ASSET FUND, LTD.	CARDARELLI ANGELO	111.803
1191	PANAGORA DYNAMIC GLOBAL EQUITY (EX TOBACCO) FUND	CARDARELLI ANGELO	69.567
1744	PANAGORA DYNAMIC GLOBAL EQUITY FUND	CARDARELLI ANGELO	21.605
101	PANAGORA DYNAMIC GLOBAL EXTENDED ALPHA FUND LTD	CARDARELLI ANGELO	13.323
725	PANAGORA GROUP TRUST .	CARDARELLI ANGELO	30.642
2421	PANAGORA RISK PARITY MULTI ASSET COLLECTIVE FUND	CARDARELLI ANGELO	2.537
1049	PARTNERS HEALTHCARE PENSION TRUST	CARDARELLI ANGELO	77.447
863	PARTNERS HEALTHCARE SYSTEM INC	CARDARELLI ANGELO	100.308
2614	PARVEST	CARDARELLI ANGELO	268.864
2615	PARVEST	CARDARELLI ANGELO	1.703.260
2618	PARVEST	CARDARELLI ANGELO	495.928
3160	PAVILION INTERNAT FOCUSED EQUITY POOL	CARDARELLI ANGELO	13.000
1947	PECO ENERGY COMPANY RETIREE MEDICAL TRUST	CARDARELLI ANGELO	23.843

ASSEMBLEA ORDINARIA

81607/1118 12 MAGGIO 2016

Segreteria Societaria - Ufficio Titoli



eni

Unica convocazione

Esito della votazione sul punto 2

Attribuzione dell'utile di esercizio

Elenco Favorevoli

SCHEMA	VPC	NOMINATIVO AZIONISTA	DELEGATO	NUMERO DI AZIONI TOTALE
307		PENN SERIES DEVELOPED INTERNATIONAL INDEX FUND	CARDARELLI ANGELO	20.206
943		PENSION FUND OF SUMITOMO MITSUI BANKING CORPORATION	CARDARELLI ANGELO	14.168
973		PENSION FUND OF SUMITOMO MITSUI BANKING CORPORATION	CARDARELLI ANGELO	14.961
637		PENSION FUND OF THE CHRISTIAN CHURCH DISCIPLES OF CHRIST	CARDARELLI ANGELO	149.636
635		PENSION FUND SOCIETY OF THE BANK OF MONTREAL	CARDARELLI ANGELO	167.347
640		PENSION RESERVES INVESTMENT TRUST FUND	CARDARELLI ANGELO	816.599
641		PENSION RESERVES INVESTMENT TRUST FUND	CARDARELLI ANGELO	1.554.275
19		PENSIONSKASSE POST	CARDARELLI ANGELO	641.887
962		PEOPLE'S BANK OF CHINA	CARDARELLI ANGELO	98.561
963		PEOPLE'S BANK OF CHINA	CARDARELLI ANGELO	209.168
966		PEOPLE'S BANK OF CHINA	CARDARELLI ANGELO	16.361
1200		PEOPLE'S BANK OF CHINA	CARDARELLI ANGELO	710.276
1201		PEOPLE'S BANK OF CHINA	CARDARELLI ANGELO	1.563.635
1210		PEOPLE'S BANK OF CHINA	CARDARELLI ANGELO	181.321
1214		PEOPLE'S BANK OF CHINA	CARDARELLI ANGELO	162.685
1216		PEOPLE'S BANK OF CHINA	CARDARELLI ANGELO	339.165
1219		PEOPLE'S BANK OF CHINA	CARDARELLI ANGELO	77.738
1977		PEPCO HOLDINGS RETIREMENT PLAN MASTER TRUST	CARDARELLI ANGELO	66.880
1882		PEPSICO CANADA ULC MASTER TRUST	CARDARELLI ANGELO	63.682
1918		PEPSICO, INC. MASTER TRUST	CARDARELLI ANGELO	233.993
3162		PERPETUAL ECONOMIC DIVERSIF. GLOBAL EQUI	CARDARELLI ANGELO	19.405
3163		PERPETUAL PRIVATE INTERNAT SHARE FUND	CARDARELLI ANGELO	25.647
2959		PETERCAM B FUND	CARDARELLI ANGELO	130.000

ASSEMBLEA ORDINARIA 12 MAGGIO 2016

Segreteria Societaria - Ufficio Titoli



Unica convocazione

Esito della votazione sul punto 2

Attribuzione dell'utile di esercizio

8160

Elenco Favorevoli

SCHEDA	VPC	NOMINATIVO AZIONISTA	DELEGATO	NUMERO DI AZIONI TOTALE
124	PETERCAM L FUND		CARDARELLI ANGELO	6.346
125	PETERCAM L FUND		CARDARELLI ANGELO	45.054
440	PETTELAAR EFFECTENBEW. INZ. SNSRESP. IND. FND		CARDARELLI ANGELO	366.806
302	PF INTERNATIONAL LARGE-CAP FUND		CARDARELLI ANGELO	126.045
638	PG&E POSTRET. MEDICAL PLAN TR.MGMT & NONBARGAINING		CARDARELLI ANGELO	3.359
2721	PI CH - EUROPEAN EX SWISS EQUITIES TRACKER EX SL		CARDARELLI ANGELO	83.330
2723	PI CH - EUROPEAN EX SWISS EQUITIES TRACKER EX SL		CARDARELLI ANGELO	241.588
1256	PINEBRIDGE GLOBAL FUNDS		CARDARELLI ANGELO	76.605
3169	PINEBRIDGE GLOBAL TRUST CLASS		CARDARELLI ANGELO	68.663
2289	PIONEER ASSET MANAGEMENT S.A		CARDARELLI ANGELO	89.890
2290	PIONEER ASSET MANAGEMENT S.A		CARDARELLI ANGELO	190.000
2291	PIONEER ASSET MANAGEMENT S.A		CARDARELLI ANGELO	2.921.408
2292	PIONEER ASSET MANAGEMENT S.A		CARDARELLI ANGELO	224.880
2286	PIONEER FUNDS - EUROP.RESEARCH		CARDARELLI ANGELO	818.707
2285	PIONEER FUNDS - ITALIAN EQUITY		CARDARELLI ANGELO	337.679
2281	PIONEER FUNDS-CORE EUR. EQUITY		CARDARELLI ANGELO	82.011
2282	PIONEER FUNDS-CORE EUR. EQUITY		CARDARELLI ANGELO	223.286
2284	PIONEER FUNDS-EUROLAND EQUITY		CARDARELLI ANGELO	3.132.776
2288	PIONEER FUNDS-GLOB.EQ.TARGET I		CARDARELLI ANGELO	1.551.340
2283	PIONEER FUNDS-GLOB.MULTI ASSET		CARDARELLI ANGELO	56.283
2287	PIONEER FUNDS-TOP EUR. PLAYERS		CARDARELLI ANGELO	1.652.381
2293	PIONEER INVESTMENT MANAGEMENT		CARDARELLI ANGELO	96.280
2294	PIONEER INVESTMENT MANAGEMENT		CARDARELLI ANGELO	98.640

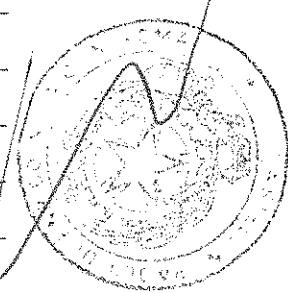

ASSEMBLEA ORDINARIA

81607/1120 12 MAGGIO 2016

Segreteria Societaria - Ufficio Titoli



eni

Unica convocazione

Esito della votazione sul punto 2

Attribuzione dell'utile di esercizio

Elenco Favorevoli

SCHEDA	VPC	NOMINATIVO AZIONISTA	DELEGATO	NUMERO DI AZIONI TOTALE
2295		PIONEER INVESTMENT MANAGEMENT	CARDARELLI ANGELO	91.220
2296		PIONEER INVESTMENT MANAGEMENT	CARDARELLI ANGELO	163.750
2230		PIONEER INVESTMENT MANAGEMENT SGRPA / AZIONARIO CRESCITA	CARDARELLI ANGELO	1.044.060
2229		PIONEER INVESTMENT MANAGEMENT SGRPA / AZIONARIO EUROPA	CARDARELLI ANGELO	714.413
2297		PIONEER STRUCTURED SOLUTION F.	CARDARELLI ANGELO	111.120
2298		PIONEER STRUCTURED SOLUTION F.	CARDARELLI ANGELO	129.570
2299		PIONEER STRUCTURED SOLUTION F.	CARDARELLI ANGELO	167.630
2300		PIONEER STRUCTURED SOLUTION F.	CARDARELLI ANGELO	65.730
2301		PIONEER STRUCTURED SOLUTION F.	CARDARELLI ANGELO	103.960
2302		PIONEER STRUCTURED SOLUTION F.	CARDARELLI ANGELO	74.820
2303		PIONEER STRUCTURED SOLUTION F.	CARDARELLI ANGELO	73.900
646		PITTSBURGH THEOLOGICAL SEMINARY OF THE PRESBYTERIAN CHURCH (USA)	CARDARELLI ANGELO	8.536
237		PNC BANK NA	CARDARELLI ANGELO	6.510
636		POINT BEACH UNIT 1 AND UNIT 2 NQ TRUST-ACCOUNTING MECHANISM	CARDARELLI ANGELO	20.031
342		POOL RE JPM REI EQUITY POOL REINSURANCE COMPANY LIMITED	CARDARELLI ANGELO	21.455
3153		POWER CORPORATION SUPERANNUATION PLA	CARDARELLI ANGELO	87.695
259		POWERSHARES GLOBAL FUNDS IRELAND PLC	CARDARELLI ANGELO	17.719
288		POWERSHARES GLOBAL FUNDS IRELAND PLC	CARDARELLI ANGELO	6.150
258		POWERSHARES GLOBAL FUNDS IRELAND PUBLIC LIMITED COMPANY	CARDARELLI ANGELO	7.433
2460		PRADO ACTIONS	CARDARELLI ANGELO	662.048
2587		PRCO COFONDS I	CARDARELLI ANGELO	25.000
813		PREDIQUANT A2 - ACTIONS EMERGENTES	CARDARELLI ANGELO	197.068
812		PREDIQUANT A2 - DIVIDENDES EURO	CARDARELLI ANGELO	481.481

ASSEMBLEA ORDINARIA 12 MAGGIO 2016

Segreteria Societaria - Ufficio Titoli



eni

Unica convocazione

Esito della votazione sul punto 2

Attribuzione dell'utile di esercizio

81607/2016

Elenco Favorevoli

SCHEDA	VPC	NOMINATIVO AZIONISTA	DELEGATO	NUMERO DI AZIONI TOTALE
814		PREDIQUANT A2 ACTIONS EUROPE	CARDARELLI ANGELO	498.440
1924		PRESBYTERIAN CHURCH (USA) FOUNDATION	CARDARELLI ANGELO	6.293
197		PREVIPOSTE	CARDARELLI ANGELO	49.117
198		PREVIPOSTE	CARDARELLI ANGELO	133.206
199		PREVIPOSTE	CARDARELLI ANGELO	70.350
1815		PRIMPOOL INC.	CARDARELLI ANGELO	6.581
304		PRINCIPAL FUNDS INC GLOBAL MULTI STRATEGY FUND	CARDARELLI ANGELO	5.303
275		PRINCIPAL FUNDS INC INTERNATIONAL VALUE FUND 1	CARDARELLI ANGELO	1.447.793
276		PRINCIPAL FUNDS INC INTERNATIONAL VALUE FUND 1	CARDARELLI ANGELO	143.901
289		PRINCIPAL FUNDS INC.-INTERNATIONAL EQUITY INDEX FUND	CARDARELLI ANGELO	172.854
402		PRINCIPAL FUNDS, INC. - SYSTEMATEX INTERNATIONAL FUND	CARDARELLI ANGELO	15.020
297		PRINCIPAL GLOBAL INVESTORS FUNDS	CARDARELLI ANGELO	7.427
47		PRINCIPAL MPF EUROPEAN EQUITY FUND	CARDARELLI ANGELO	7.685
41		PRINCIPAL TRUST COMPANY ASIA LIMITED	CARDARELLI ANGELO	6.033
447		PROMEDICA HEALTH SYSTEM INC. CASH BALANCE RETIREM	CARDARELLI ANGELO	18.976
446		PROMEDICA HEALTH SYSTEM TRUST	CARDARELLI ANGELO	58.600
3130		PROSHARES HEDGED FTSE EUROPE ETF	CARDARELLI ANGELO	1.630
3152		PROVINCE OF PRINCE EDWARD ISL MASTER TR	CARDARELLI ANGELO	119.544
620		PROVINCE PF NEWFOUNLAND AND LABRADOR POOLED PENSION FUND	CARDARELLI ANGELO	34.715
3186		PRUDENTIAL ASSURANCE COMPANY LTD	CARDARELLI ANGELO	5.133.396
3188		PRUDENTIAL ASSURANCE COMPANY LTD	CARDARELLI ANGELO	69.948
3189		PRUDENTIAL ASSURANCE COMPANY LTD	CARDARELLI ANGELO	459.072
3191		PRUDENTIAL ASSURANCE COMPANY LTD	CARDARELLI ANGELO	120.270

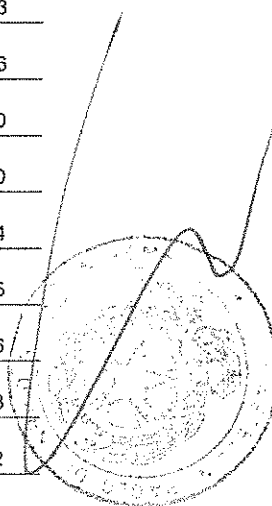

ASSEMBLEA ORDINARIA

81607/122 12 MAGGIO 2016

Segreteria Societaria - Ufficio Titoli



eni

Unica convocazione

Esito della votazione sul punto 2

Attribuzione dell'utile di esercizio**Elenco Favorevoli**

SCHEDA	VPC	NOMINATIVO AZIONISTA	DELEGATO	NUMERO DI AZIONI TOTALE
3187		PRUDENTIAL PENSIONS LIMITED	CARDARELLI ANGELO	237.487
3190		PRUDENTIAL PENSIONS LIMITED	CARDARELLI ANGELO	50.497
1321		PRUDENTIAL RETIREMENT INSURANCE & ANNUITY COMPANY	CARDARELLI ANGELO	161.815
1322		PRUDENTIAL RETIREMENT INSURANCE & ANNUITY COMPANY	CARDARELLI ANGELO	83.518
1323		PRUDENTIAL RETIREMENT INSURANCE & ANNUITY COMPANY	CARDARELLI ANGELO	7.295
1324		PRUDENTIAL RETIREMENT INSURANCE & ANNUITY COMPANY	CARDARELLI ANGELO	22.813
254		PS FTSE RAFI DEVEL MAR EXUS PORT	CARDARELLI ANGELO	367.538
2304		PSF-DIV TARGET INC 112021	CARDARELLI ANGELO	13.100
642		PUBLIC EMPLOYEE RETIREMENT SYSTEM OF IDAHO	CARDARELLI ANGELO	93.370
643		PUBLIC EMPLOYEE RETIREMENT SYSTEM OF IDAHO	CARDARELLI ANGELO	456.750
644		PUBLIC EMPLOYEE RETIREMENT SYSTEM OF IDAHO	CARDARELLI ANGELO	605.407
1954		PUBLIC EMPLOYEES RETIREMENT ASSOCIATION OF COLORADO	CARDARELLI ANGELO	1.379.401
2042		PUBLIC EMPLOYEES RETIREMENT ASSOCIATION OF COLORADO	CARDARELLI ANGELO	711.168
612		PUBLIC EMPLOYEES RETIREMENT SYSTEM OF MISSISSIPPI	CARDARELLI ANGELO	283.253
623		PUBLIC EMPLOYEES RETIREMENT SYSTEM OF NEVADA	CARDARELLI ANGELO	884.624
624		PUBLIC EMPLOYEES RETIREMENT SYSTEM OF NEVADA	CARDARELLI ANGELO	413.631
2960		PUBLIC EMPLOYEES RETIREMENT SYSTEM OF OH	CARDARELLI ANGELO	152.853
2961		PUBLIC EMPLOYEES RETIREMENT SYSTEM OF OH	CARDARELLI ANGELO	180.017
500		PUBLIC SCHOOL TEACHERS' PENSION AND RETIREMENT FUND OF CHICAGO	CARDARELLI ANGELO	139.170
680		PUBLIC SECTOR PENSION INVESTMENT BOARD	CARDARELLI ANGELO	142.741
681		PUBLIC SECTOR PENSION INVESTMENT BOARD	CARDARELLI ANGELO	261.731
682		PUBLIC SECTOR PENSION INVESTMENT BOARD	CARDARELLI ANGELO	343.372
683		PUBLIC SECTOR PENSION INVESTMENT BOARD	CARDARELLI ANGELO	402.917

ASSEMBLEA ORDINARIA 12 MAGGIO 2016

Segreteria Societaria - Ufficio Titoli



eni

Unica convocazione

Esito della votazione sul punto 2

Attribuzione dell'utile di esercizio

81607/1123

M

Elenco Favorevoli

SCHEDA VPC	NOMINATIVO AZIONISTA	DELEGATO	NUMERO DI AZIONI TOTALE
457	PUBLIC SERVICE ENTERPRISE GROUPMASTER RETIREMENT TRUST CARDARELLI ANGELO		51.675
621	PUBLIC SERVICE PENSION PLAN FUND CARDARELLI ANGELO		38.300
904	PUTNAM DYNAMIC ASSET ALLOCATION BALANCED FUND CARDARELLI ANGELO		19.317
905	PUTNAM DYNAMIC ASSET ALLOCATION CONSERVATIVE FUND CARDARELLI ANGELO		3.881
903	PUTNAM DYNAMIC ASSET ALLOCATION GROWTH FUND CARDARELLI ANGELO		29.963
901	PUTNAM GLOBAL DIVIDEND FUND CARDARELLI ANGELO		5.459
914	PUTNAM GLOBAL ENERGY FUND CARDARELLI ANGELO		82.726
909	PUTNAM GLOBAL EQUITY FUND CARDARELLI ANGELO		244.034
902	PUTNAM GLOBAL NATURAL RESOURCES FUND CARDARELLI ANGELO		525.792
906	PUTNAM INVESTMENT FUNDS - PUTNAM RESEARCH FUND CARDARELLI ANGELO		49.795
98	PUTNAM SELECT GLOBAL EQUITY FUND LP C.O. THE PUTNAM ADVISORY COMPANY LLC CARDARELLI ANGELO		2.146
99	PUTNAM SELECT U.S EQUITY FUND LP C/O THE PUTNAM ADVISORY COMPANY LLC CARDARELLI ANGELO		483
913	PUTNAM TOTAL RETURN FUND, LLC CARDARELLI ANGELO		796
912	PUTNAM TOTAL RETURN TRUST CARDARELLI ANGELO		2.912
911	PUTNAM VARIABLE TR - PUTNAM VT THE GEORGE PUTNAM F OF BOSTON CARDARELLI ANGELO		14.680
910	PUTNAM VARIABLE TRUST - PUTNAM VT GLOBAL EQUITY FUND CARDARELLI ANGELO		50.705
907	PUTNAM VARIABLE TRUST - PUTNAM VT RESEARCH FUND CARDARELLI ANGELO		8.554
1161	PUTNAM WORLD TRUST CARDARELLI ANGELO		2.173
1841	PYRAMIS GLOBAL EX U.S.INDEX FUND LP CARDARELLI ANGELO		227.019
1855	PZENA INTERNATIONAL VALUE SERVICE CARDARELLI ANGELO		5.356
2388	PZENA VALUE FUNDS PL CARDARELLI ANGELO		118.214
2407	PZENA VALUE FUNDS PL CARDARELLI ANGELO		60.188
1978	PZENA VALUE GROUP TRUST CARDARELLI ANGELO		95.775

M

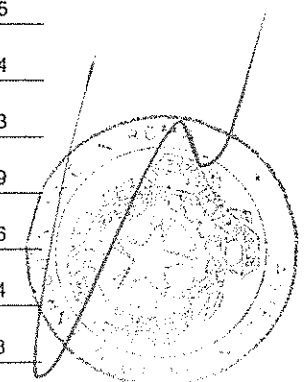

ASSEMBLEA ORDINARIA

81607/1124 12 MAGGIO 2016

Segreteria Societaria - Ufficio Titoli



eni

Unica convocazione

Esito della votazione sul punto 2

Attribuzione dell'utile di esercizio

Elenco Favorevoli

SCHEDA	VPC	NOMINATIVO AZIONISTA	DELEGATO	NUMERO DI AZIONI TOTALE
1979		PZENA VALUE GROUP TRUST	CARDARELLI ANGELO	141.150
1853		PZENA VALUE TRUST	CARDARELLI ANGELO	42.459
3268		Pensioenfonds Fortis ASR	CARDARELLI ANGELO	117.207
2730		Pictet-Europe Index	CARDARELLI ANGELO	143.805
2731		Pictet-Europe Index	CARDARELLI ANGELO	580.540
1891		QIC INTERNATIONAL EQUITIES FUND	CARDARELLI ANGELO	20.299
2741		QUAESTIO INVESTMENTS	CARDARELLI ANGELO	17.118
1892		QUEENSLAND INVESTMENT TRUST NO.2	CARDARELLI ANGELO	36.743
748		QUERCUS	CARDARELLI ANGELO	341.010
770		R PHARMA DVSF	CARDARELLI ANGELO	40.000
718		R.K. MELLON INTERNATIONAL FUND.	CARDARELLI ANGELO	70.047
719		R.K. MELLON INTERNATIONAL FUND.	CARDARELLI ANGELO	22.000
3033		RAGS-FUNDMASTER	CARDARELLI ANGELO	18.977
244		RAILWAYS PENSION TRUSTEE COMPANY LIMITED.	CARDARELLI ANGELO	7.441
245		RAILWAYS PENSION TRUSTEE COMPANY LIMITED.	CARDARELLI ANGELO	363.645
1858		RAMI PARTNERS, LLC	CARDARELLI ANGELO	4.542
841		RAYTHEON MASTER PENSION TRUST	CARDARELLI ANGELO	6.446
3168		RBC CANADIAN MASTER TRUST	CARDARELLI ANGELO	201.078
2740		RBC FUNDS LUX	CARDARELLI ANGELO	18.100
3165		RBC GLOBAL ENERGY FUND	CARDARELLI ANGELO	538.471
3146		RBC GLOBAL RESOURCES SECTOR FUND	CARDARELLI ANGELO	157.700
3144		RBC QUANT EAFE EQUITY LEADERS ETF	CARDARELLI ANGELO	4.500
3143		RBC QUBE ALL COUNTRY WORLD EQUITY FUND	CARDARELLI ANGELO	11.300

ASSEMBLEA ORDINARIA 12 MAGGIO 2016

Segreteria Societaria - Ufficio Titoli



Unica convocazione

Esito della votazione sul punto 2

Attribuzione dell'utile di esercizio

81607/1125

3

Elenco Favorevoli

SCHEDA	VPC	NOMINATIVO AZIONISTA	DELEGATO	NUMERO DI AZIONI TOTALE
3145		RBC QUBE GLOBAL EQUITY FUND	CARDARELLI ANGELO	127.000
3198		RBC QUBE MARKET NEUTRAL WORLD EQUITY FUND	CARDARELLI ANGELO	2.700
267		RBS CITIZENS N.A GLB MANAGED USD	CARDARELLI ANGELO	705
555		RE GINNA QUALIFIED DECOMMISSIONING TRUST	CARDARELLI ANGELO	11.700
3174		REASSURE LIMITED	CARDARELLI ANGELO	518.796
2046		REBUS GROUP PENSION SCHEME	CARDARELLI ANGELO	224.392
2047		REBUS GROUP PENSION SCHEME	CARDARELLI ANGELO	760.000
2048		REBUS GROUP PENSION SCHEME	CARDARELLI ANGELO	33.365
3245		REG RETR EMPL MANUELS VILLE MONTREAL	CARDARELLI ANGELO	9.643
3161		REGIME DE RETRAITE D HYDRO QUEBEC	CARDARELLI ANGELO	194.268
3246		REGIME DE RETRAITE DE L'UNIVER DU QUEBEC	CARDARELLI ANGELO	31.518
388		REGIONAL TRANSPORTATION DISTRICT SALARIED PENSION PLAN	CARDARELLI ANGELO	2.591
709		RENAISSANCE GLOBAL VALUE FUND	CARDARELLI ANGELO	28.228
647		RESOLUTE FOREIGN EQUITY MASTER TRUST FUND	CARDARELLI ANGELO	384.209
1328		RESOURCE STOCK INDEX COMMON TRUST FUND	CARDARELLI ANGELO	271.642
2634		RESPONSIBLE INVESTMENT LEADERS INT SHARE	CARDARELLI ANGELO	11.160
301		RETIR.PL.EMPL.SOUTH BROWARD HOSPITAL DISTRICT HOLLYWOOD FLORIDATRICT HOLLYWOOD FI	CARDARELLI ANGELO	34.360
2914		RETIREMENT BENEFITS FUND BOARD	CARDARELLI ANGELO	108.425
625		RETIREMENT BENEFITS INVESTMENT FUND	CARDARELLI ANGELO	14.223
2918		RETIREMENT INCOME PLAN OF SAUDI ARABIAN OIL COMPANY	CARDARELLI ANGELO	6.608
2919		RETIREMENT INCOME PLAN OF SAUDI ARABIAN OIL COMPANY	CARDARELLI ANGELO	6.020
2877		RETIREMENT PLAN FOR EMPLOYEES OF AETNA I	CARDARELLI ANGELO	213.000
1164		RETIREMNT & SEC PROG. & SAVNGS PLN OF NTCA & ITS MBRS MSTR TST	CARDARELLI ANGELO	7.759

2

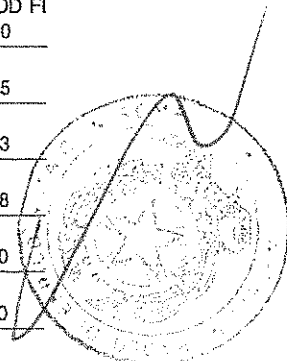

ASSEMBLEA ORDINARIA

81607/1126 12 MAGGIO 2016

Segreteria Societaria - Ufficio Titoli



eni

Unica convocazione

Esito della votazione sul punto 2

Attribuzione dell'utile di esercizio

Elenco Favorevoli

SCHEDA	VPC	NOMINATIVO AZIONISTA	DELEGATO	NUMERO DI AZIONI TOTALE
745	REUNICA CAAM ACTIONS		CARDARELLI ANGELO	11
817	REUNICA CPR ACTIONS		CARDARELLI ANGELO	89.437
360	REVENUESHARES GLOBAL GROWTH FUND		CARDARELLI ANGELO	2.347
932	RHODE ISLAND HIGHER EDUCATION SAVINGS TRUST		CARDARELLI ANGELO	11.000
352	RIVER AND MERCANTILE DYNAMIC ASSET ALLOCATION FUND		CARDARELLI ANGELO	3.900
334	RIVER AND MERCANTILE WORLD RECOVERY FUND		CARDARELLI ANGELO	73.000
859	RIVERSIDE CHURCH IN THE CITY OF NEW YORK		CARDARELLI ANGELO	20.141
2737	ROBECO CAPITAL GROWTH FUNDS		CARDARELLI ANGELO	471.716
32	ROBECO INSTITUTIONEEL GLOBAL ENHANCED INDEX FONDS		CARDARELLI ANGELO	16.740
97	ROBECO INVESTMENT MANAGEMENT INC (DBA BOSTON PARTNERS)		CARDARELLI ANGELO	1.510
78	ROBECO UMBRELLA FUND I N.V. - ROBECO GLOBAL AC MULTI-FACTOR EQ. FUND		CARDARELLI ANGELO	182.604
877	ROBERT L MCNEIL COMPLEX TRUST		CARDARELLI ANGELO	57.020
420	ROBINSON UNIT 2 QUALIFIED NUCLEAR DECOMMISSIONING FUND		CARDARELLI ANGELO	17.194
1064	ROCHE U.S. RETIREMENT PLANS MASTER TRUST		CARDARELLI ANGELO	387.655
2850	ROCKEFELLER & CO., INC		CARDARELLI ANGELO	202.027
733	ROGERSCASEY TARGET SOLUTIONS LLC.		CARDARELLI ANGELO	547
734	ROGERSCASEY TARGET SOLUTIONS LLC.		CARDARELLI ANGELO	6.530
846	ROTHSCHILD & CIE BANQUE BACK OFFICES		CARDARELLI ANGELO	1.504.000
2250	ROTHSCHILD AND CIE GESTION		CARDARELLI ANGELO	37.000
84	ROUNDTABLE EVERKEY GLOBAL FOCUS FUND C/O WELLS CAPITAL MANAGEMENT INCORPORATED		CARDARELLI ANGELO	40.489
2719	RP FAMILY		CARDARELLI ANGELO	1.000
1366	RP RENDITE PLUS		CARDARELLI ANGELO	18.130
1367	RP RENDITE PLUS		CARDARELLI ANGELO	18.060

ASSEMBLEA ORDINARIA 12 MAGGIO 2016

Segreteria Societaria - Ufficio Titoli



Unica convocazione

Esito della votazione sul punto 2

Attribuzione dell'utile di esercizio

8160/112

Elenco Favorevoli

SCHEDA	VPC	NOMINATIVO AZIONISTA	DELEGATO	NUMERO DI AZIONI TOTALE
1368	RP	RENDITE PLUS	CARDARELLI ANGELO	15.220
965	RS	INTERNATIONAL FUND	CARDARELLI ANGELO	14.773
964	RS	INTERNATIONAL VIP SERIES	CARDARELLI ANGELO	99.854
3043	RSAMPENSION INVEST, GLOBALT	AKTIEINDEKS	CARDARELLI ANGELO	258.340
844	RUSSEL INSTITUTIONAL FUNDS, LLC-	RUSSELL LOW DURATION BOND FUNDPLUS FU	CARDARELLI ANGELO	51.425
1096	RUSSELL COMMON CONTRACTUAL FUND		CARDARELLI ANGELO	117.345
1457	RUSSELL DEVELOPED EX-U.S. LARGE CAP	INDEX FUND B	CARDARELLI ANGELO	18.609
1468	RUSSELL DEVELOPED LARGE CAP EM	GEOEXPOSURE INDEX FUND B	CARDARELLI ANGELO	37.853
473	RUSSELL GLOBAL EQUITY FUND .		CARDARELLI ANGELO	20.671
474	RUSSELL GLOBAL EQUITY FUND .		CARDARELLI ANGELO	159.420
479	RUSSELL GLOBAL EQUITY POOL		CARDARELLI ANGELO	8.027
480	RUSSELL GLOBAL EQUITY POOL		CARDARELLI ANGELO	61.790
1734	RUSSELL GLOBAL OPPORTUNITIES FUND		CARDARELLI ANGELO	483.180
653	RUSSELL INSTITUTIONAL FUNDS	LLC RUSSELL GLBL EQTY PLUS FND	CARDARELLI ANGELO	5.212
845	RUSSELL INSTITUTIONAL FUNDS LLC	RUSSELL INTERNATIONAL EQUITY FD	CARDARELLI ANGELO	126.025
651	RUSSELL INSTITUTIONAL FUNDS LLC	RUSSELL INTL EQUITY FUND	CARDARELLI ANGELO	176.493
652	RUSSELL INSTITUTIONAL FUNDS LLC	RUSSELL INTL EQUITY FUND	CARDARELLI ANGELO	5.603
1729	RUSSELL INTERNATIONAL SHARES FUND		CARDARELLI ANGELO	100.080
995	RUSSELL INVESTMENT COMPANY -	RUSSELL INTERN DEVELOPED MKT F	CARDARELLI ANGELO	497.816
1517	RUSSELL INVESTMENT COMPANY -	RUSSELL INTERN DEVELOPED MKT F	CARDARELLI ANGELO	113.492
1518	RUSSELL INVESTMENT COMPANY -	RUSSELL INTERN DEVELOPED MKT F	CARDARELLI ANGELO	673.284
1519	RUSSELL INVESTMENT COMPANY -	RUSSELL INTERN DEVELOPED MKT F	CARDARELLI ANGELO	501.095
1484	RUSSELL INVESTMENT COMPANY II	PLC	CARDARELLI ANGELO	140.925

ASSEMBLEA ORDINARIA

81607/1228 12 MAGGIO 2016

Segreteria Societaria - Ufficio Titoli



eni

Unica convocazione

Esito della votazione sul punto 2

Attribuzione dell'utile di esercizio

Elenco Favorevoli

SCHEDA	VPC	NOMINATIVO AZIONISTA	DELEGATO	NUMERO DI AZIONI TOTALE
1485		RUSSELL INVESTMENT COMPANY II PLC	CARDARELLI ANGELO	105.801
1486		RUSSELL INVESTMENT COMPANY II PLC	CARDARELLI ANGELO	114.070
1549		RUSSELL INVESTMENT COMPANY II PLC	CARDARELLI ANGELO	457.190
1086		RUSSELL INVESTMENT COMPANY IV PLC	CARDARELLI ANGELO	43.568
1087		RUSSELL INVESTMENT COMPANY IV PLC	CARDARELLI ANGELO	51.390
939		RUSSELL INVESTMENT COMPANY PLC	CARDARELLI ANGELO	1.856.300
1084		RUSSELL INVESTMENT COMPANY PLC	CARDARELLI ANGELO	180.630
1134		RUSSELL INVESTMENT COMPANY PLC	CARDARELLI ANGELO	168.601
1136		RUSSELL INVESTMENT COMPANY PLC	CARDARELLI ANGELO	114.108
1550		RUSSELL INVESTMENT COMPANY PLC	CARDARELLI ANGELO	175.410
1551		RUSSELL INVESTMENT COMPANY PLC	CARDARELLI ANGELO	150.973
996		RUSSELL INVESTMENT COMPANY RUSSELL GLOBAL EQUITY FUND	CARDARELLI ANGELO	68.802
1047		RUSSELL INVESTMENT COMPANY RUSSELL TAX-MANAGED INTL EQ FUND	CARDARELLI ANGELO	131.803
1048		RUSSELL INVESTMENT COMPANY SELECT INTERNATIONAL EQUITY FUND	CARDARELLI ANGELO	163.826
1533		RUSSELL INVESTMENT FUNDS NON-U.S. FUND	CARDARELLI ANGELO	101.175
1534		RUSSELL INVESTMENT FUNDS NON-U.S. FUND	CARDARELLI ANGELO	113.007
1535		RUSSELL INVESTMENT FUNDS NON-U.S. FUND	CARDARELLI ANGELO	28.342
1118		RUSSELL MULTI-ASSET FACTOR EXPOSURE FUND	CARDARELLI ANGELO	46.848
469		RUSSELL OVERSEAS EQUITY FUND .	CARDARELLI ANGELO	106.400
470		RUSSELL OVERSEAS EQUITY FUND .	CARDARELLI ANGELO	31.137
471		RUSSELL OVERSEAS EQUITY FUND .	CARDARELLI ANGELO	92.717
472		RUSSELL OVERSEAS EQUITY FUND .	CARDARELLI ANGELO	84.560
475		RUSSELL OVERSEAS EQUITY POOL .	CARDARELLI ANGELO	27.839

ASSEMBLEA ORDINARIA 12 MAGGIO 2016

Segreteria Societaria - Ufficio Titoli



eni

Unica convocazione

Esito della votazione sul punto 2

Attribuzione dell'utile di esercizio

81607/1129

Elenco Favorevoli

SCHEDA	VPC	NOMINATIVO AZIONISTA	DELEGATO	NUMERO DI AZIONI TOTALE
476		RUSSELL OVERSEAS EQUITY POOL .	CARDARELLI ANGELO	94.936
477		RUSSELL OVERSEAS EQUITY POOL .	CARDARELLI ANGELO	91.100
478		RUSSELL OVERSEAS EQUITY POOL .	CARDARELLI ANGELO	76.530
1736		RUSSELL TAX EFFECTIVE GLOBAL SHARES FUND	CARDARELLI ANGELO	3.022
937		RUSSELL TRUST CO COMMINGLED EMPLOYEE BENEFIT FUNDS TRUST	CARDARELLI ANGELO	40.679
938		RUSSELL TRUST CO COMMINGLED EMPLOYEE BENEFIT FUNDS TRUST	CARDARELLI ANGELO	203.917
948		RUSSELL TRUST CO COMMINGLED EMPLOYEE BENEFIT FUNDS TRUST	CARDARELLI ANGELO	124.160
949		RUSSELL TRUST CO COMMINGLED EMPLOYEE BENEFIT FUNDS TRUST	CARDARELLI ANGELO	3.077
1498		RUSSELL TRUST CO COMMINGLED EMPLOYEE BENEFIT FUNDS TRUST	CARDARELLI ANGELO	763.019
1499		RUSSELL TRUST CO COMMINGLED EMPLOYEE BENEFIT FUNDS TRUST	CARDARELLI ANGELO	191.554
1500		RUSSELL TRUST CO COMMINGLED EMPLOYEE BENEFIT FUNDS TRUST	CARDARELLI ANGELO	568.824
1501		RUSSELL TRUST CO COMMINGLED EMPLOYEE BENEFIT FUNDS TRUST	CARDARELLI ANGELO	64.370
1502		RUSSELL TRUST CO COMMINGLED EMPLOYEE BENEFIT FUNDS TRUST	CARDARELLI ANGELO	800.855
2233		RWC FUNDS	CARDARELLI ANGELO	182.699
2722		Raiffeisen Index Fonds	CARDARELLI ANGELO	51.817
1727		Russell Investment Company Russell Multi-Strategy Alternative Fund	CARDARELLI ANGELO	7.240
2439		SAINT MARTIN 2	CARDARELLI ANGELO	91.475
1587		SAINT-GOBAIN CORPORATION DEFINED BENEFIT MASTER TRUST	CARDARELLI ANGELO	78.689
1504		SAN DIEGO CITY EMPLOYEES' RETIREMENT SYSTEM	CARDARELLI ANGELO	308.270
1031		SAN JOSE FEDERATED RETIREE HEALTH CARE TRUST FUND	CARDARELLI ANGELO	3.347
1798		SAN MATEO EMPLOYEES RETIREMENT ASSOCIATION	CARDARELLI ANGELO	246.848
1773		SANABIL INTERNATIONAL INVESTMENTS COMPANY	CARDARELLI ANGELO	65.900
2412		SANLAM GLOBAL FUNDS PLC	CARDARELLI ANGELO	60.162

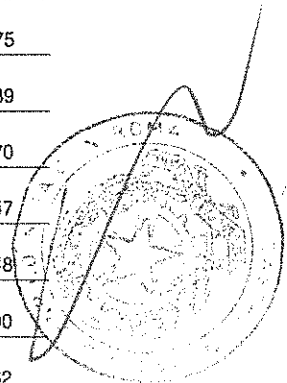

81607/1130

ASSEMBLEA ORDINARIA**12 MAGGIO 2016**

Segreteria Societaria - Ufficio Titoli



eni

Unica convocazione

Esito della votazione sul punto 2

Attribuzione dell'utile di esercizio

Elenco Favorevoli

SCHEDA	VPC	NOMINATIVO AZIONISTA	DELEGATO	NUMERO DI AZIONI TOTALE
2966		SANLAM LIFE AND PENSIONS UK LIMITED	CARDARELLI ANGELO	37.543
2410		SANLAM UNIVERSAL FUNDS PLC	CARDARELLI ANGELO	368.712
2411		SANLAM UNIVERSAL FUNDS PLC	CARDARELLI ANGELO	30.903
2418		SANLAM UNIVERSAL FUNDS PLC	CARDARELLI ANGELO	131.773
839		SANTA BARBARA COUNTY EMPLOYEES RETIREMENT SYSTEM	CARDARELLI ANGELO	18.625
2836		SAS TRUSTEE CORPORATION	CARDARELLI ANGELO	28.724
2838		SAS TRUSTEE CORPORATION	CARDARELLI ANGELO	61.932
2839		SAS TRUSTEE CORPORATION	CARDARELLI ANGELO	184.173
3232		SAS TRUSTEE CORPORATION	CARDARELLI ANGELO	47.235
2928		SBC MASTER PENSION TRUST	CARDARELLI ANGELO	157.926
2931		SBC MASTER PENSION TRUST	CARDARELLI ANGELO	86.305
2932		SBC MASTER PENSION TRUST	CARDARELLI ANGELO	403.957
2936		SBC MASTER PENSION TRUST SBC MASTER PENSION TRUST 208	CARDARELLI ANGELO	143.047
339		SBSA ENGINEERING INDUSTRIES PENSION FUND	CARDARELLI ANGELO	293.300
299		SBSA ITF SANLAM GLOBAL EQUITY FUND FOUR CAPITAL PARTNERS LIMITED	CARDARELLI ANGELO	73.826
1797		SCHLUMBERGER COMMON INVESTMENT FUND	CARDARELLI ANGELO	124.638
3082		SCHRODER ADVANCED BETA GLOBAL EQUITY SMA	CARDARELLI ANGELO	73.915
3034		SCHRODER DIVERSIFIED GROWTH FUND	CARDARELLI ANGELO	847.686
3138		SCHRODER DIVERSIFIED GROWTH PORTFOLIO, L	CARDARELLI ANGELO	25.268
3085		SCHRODER EUROPEAN ALPHA PLUS FUND	CARDARELLI ANGELO	1.639.507
3286		SCHRODER EUROPEAN ALPHA PLUS FUND	CARDARELLI ANGELO	2.375.799
3084		SCHRODER EUROPEAN FUND	CARDARELLI ANGELO	752.862
3083		SCHRODER GLOBAL EQUITY INCOME FUND	CARDARELLI ANGELO	219.331

ASSEMBLEA ORDINARIA 12 MAGGIO 2016

Segreteria Societaria - Ufficio Titoli



Unica convocazione

Esito della votazione sul punto 2

Attribuzione dell'utile di esercizio

81607/131

M

Elenco Favorevoli

SCHEDA	VPC NOMINATIVO AZIONISTA	DELEGATO	NUMERO DI AZIONI TOTALE
3206	SCHRODER INCOME GROWTH FUND PLC CARDARELLI ANGELO		193.619
2763	SCHRODER INTERNATIONAL SELECTION FUND CARDARELLI ANGELO		114.373
2764	SCHRODER INTERNATIONAL SELECTION FUND CARDARELLI ANGELO		99.609
2768	SCHRODER INTERNATIONAL SELECTION FUND CARDARELLI ANGELO		16.902
2769	SCHRODER INTERNATIONAL SELECTION FUND CARDARELLI ANGELO		2.508.522
2770	SCHRODER INTERNATIONAL SELECTION FUND CARDARELLI ANGELO		113.927
2771	SCHRODER INTERNATIONAL SELECTION FUND CARDARELLI ANGELO		4.534.971
2773	SCHRODER INTERNATIONAL SELECTION FUND CARDARELLI ANGELO		4.634.289
2774	SCHRODER INTERNATIONAL SELECTION FUND CARDARELLI ANGELO		831.343
2776	SCHRODER INTERNATIONAL SELECTION FUND CARDARELLI ANGELO		540.128
2777	SCHRODER INTERNATIONAL SELECTION FUND CARDARELLI ANGELO		767.324
2781	SCHRODER INTERNATIONAL SELECTION FUND CARDARELLI ANGELO		31.542
2785	SCHRODER INTERNATIONAL SELECTION FUND CARDARELLI ANGELO		67.988
3136	SCHRODER OPERS GLOBAL ALLOCATION PORTFOL CARDARELLI ANGELO		34.914
3035	SCHRODERS DYNAMIC MULTI ASSET FUND CARDARELLI ANGELO		44.606
2402	SCHWAB FUNDAMENTAL INTER LARGE COMP IN F CARDARELLI ANGELO		574.936
891	SCHWAB FUNDAMENTAL INTERNATIONAL LARGE COMPANY ETF CARDARELLI ANGELO		663.041
890	SCHWAB INTERNATIONAL EQUITY ETF CARDARELLI ANGELO		927.342
2358	SCHWAB INTERNATIONAL INDEX FUND CARDARELLI ANGELO		617.816
1725	SCOTTISH WID INV SOLS F ICVC - FDAMNTL LOW VOL IND GLO EQT F CARDARELLI ANGELO		222.158
1726	SCOTTISH WIDOWS INV SOL F ICVC- FUNDAMENTAL INDEX GLB EQ F CARDARELLI ANGELO		613.415
1674	SCOTTISH WIDOWS INV SOLUTIONS F ICVC- EUROPEAN (EX UK) EQ FD CARDARELLI ANGELO		898.565
1671	SCOTTISH WIDOWS OVERSEAS GROWTH INV F ICVC - EURO GROWTH F CARDARELLI ANGELO		570.747

M

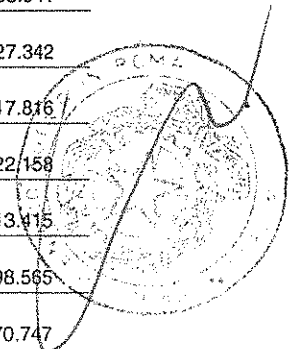

ASSEMBLEA ORDINARIA

81607 FU32 12 MAGGIO 2016

Segreteria Societaria - Ufficio Titoli



eni

Unica convocazione

Esito della votazione sul punto 2

Attribuzione dell'utile di esercizio

Elenco Favorevoli

SCHEDA	VPC	NOMINATIVO AZIONISTA	DELEGATO	NUMERO DI AZIONI TOTALE
1672		SCOTTISH WIDOWS OVERSEAS GROWTH INV FUNDS ICVC-GLOBAL GROW F	CARDARELLI ANGELO	286.700
52		SDA INTL EQUITY INDEX FD WORLD	CARDARELLI ANGELO	57.657
721		SDGE QUALIFIED NUCLEAR DECOM MISSIONING TRUST PARTNERSHIP	CARDARELLI ANGELO	12.696
1093		SEASONS SERIES TRUST INTERNATIONAL EQUITY PORTFOLIO	CARDARELLI ANGELO	48.455
333		SECURITY EQUITY FUND - MSCI EAFE EQUAL WEIGHT FUND	CARDARELLI ANGELO	19.800
2403		SEI INSTITUTIONAL MANAGED TRUST MULTI-AS	CARDARELLI ANGELO	10.812
1385		SELECT INDEX SERIES	CARDARELLI ANGELO	142.775
662		SEMPRA ENERGY PENSION MASTER TRUST	CARDARELLI ANGELO	101.234
284		SEVENTH SWEDISH NATIONAL PENSION FUND - AP7 EQUITY FUND	CARDARELLI ANGELO	2.195.900
2269		SG ACTIONS ENERGIE	CARDARELLI ANGELO	15
2274		SG ACTIONS EURO SELECTION	CARDARELLI ANGELO	840.487
2271		SG ACTIONS EURO VALUE	CARDARELLI ANGELO	327.051
2272		SG ACTIONS EUROPE	CARDARELLI ANGELO	26.560
2270		SG ACTIONS EUROPE ISR	CARDARELLI ANGELO	40.782
2259		SG ACTIONS EUROPE MULTIGESTION	CARDARELLI ANGELO	19.891
2256		SG ACTIONS EUROPE SELECTION	CARDARELLI ANGELO	32.885
2247		SG ACTIONS INTERNATIONALES	CARDARELLI ANGELO	51.069
2273		SG ACTIONS MONDE	CARDARELLI ANGELO	468
2246		SG DIVERSIFIE ISR	CARDARELLI ANGELO	64.472
663		SHELL PENSION TRUST .	CARDARELLI ANGELO	134.431
664		SHELL PENSION TRUST .	CARDARELLI ANGELO	82.769
2972		SHELL PENSIONS TRUST LIMITED AS TRUSTEE OF SHELL CONTRIBUTORY PENSION FUND	CARDARELLI ANGELO	9.045
2973		SHELL PENSIONS TRUST LIMITED AS TRUSTEE OF SHELL CONTRIBUTORY PENSION FUND	CARDARELLI ANGELO	115.882

ASSEMBLEA ORDINARIA 12 MAGGIO 2016

Segreteria Societaria - Ufficio Titoli



Unica convocazione

Esito della votazione sul punto 2

Attribuzione dell'utile di esercizio

81607/1133

[Handwritten signature]

Elenco Favorevoli

SCHEDA	VPC	NOMINATIVO AZIONISTA	DELEGATO	NUMERO DI AZIONI TOTALE
2802		SHELL TRUST (BERMUDA) LIMITED AS TRUSTEE	CARDARELLI ANGELO	442
2735		SHINKO GLOBAL EQUITY INDEX MOTHER FUND	CARDARELLI ANGELO	6.538
136		SICAV AMUNDI ACTIONS EURO ISR	CARDARELLI ANGELO	17
132		SICAV AMUNDI SELECT EUROPE	CARDARELLI ANGELO	19
2479		SICAV UBS F OPP MONDE 10	CARDARELLI ANGELO	6.858
60		SIEFORE BANAMEX BASICA 2 SA DE CV	CARDARELLI ANGELO	105.347
61		SIEFORE BANAMEX BASICA 3 SA DE CV	CARDARELLI ANGELO	131.292
63		SIEFORE BANAMEX BASICA 4 SA DE CV	CARDARELLI ANGELO	144.415
3105		SIERRA TEMPLETON INTERNAT EQUITY TRUST	CARDARELLI ANGELO	158.649
1570		SIONNA CANADIAN BALANCED FUND	CARDARELLI ANGELO	19.900
1147		SIONNA CANADIAN EQUITY FUND	CARDARELLI ANGELO	33.745
1230		SIR DAVID TRENCH FUND FOR RECREATION	CARDARELLI ANGELO	2.264
731		SISTERS OF CHARITY OF LEAVENWORTH HEALTH SVCS CORP MASTER TRUST	CARDARELLI ANGELO	20.764
730		SISTERS OF CHARITY OF LEAVENWORTH HEALTH SYSTEM MASTER TRUST	CARDARELLI ANGELO	94.862
661		SMITHFIELD FOODS MASTER TRUST	CARDARELLI ANGELO	33.161
660		SMITHFIELDS FOODS MASTER TRUST	CARDARELLI ANGELO	21.187
2974		SOMERSET COUNTY COUNCIL PENSION FUND	CARDARELLI ANGELO	61.945
2356		SONDERVERMOGEN MI_FONDS F22	CARDARELLI ANGELO	91.500
1475		SONOMA COUNTY EMPLOYEES RETIREMENT ASSOCIATION	CARDARELLI ANGELO	90.568
1476		SONOMA COUNTY EMPLOYEES RETIREMENT ASSOCIATION	CARDARELLI ANGELO	55.359
1271		SOUTH CALIF UTD FOOD & COMM WK UN & FOOD EMPL JOINT PENS TR F	CARDARELLI ANGELO	246.097
3182		SOUTH YORKSHIRE PENSIONS AUTHORITY	CARDARELLI ANGELO	385.000
1796		SOUTHERN CALIF UN FOOD & COMM WORK UNIONS & DRUG EMPL PENS F	CARDARELLI ANGELO	30.187

[Handwritten signature]

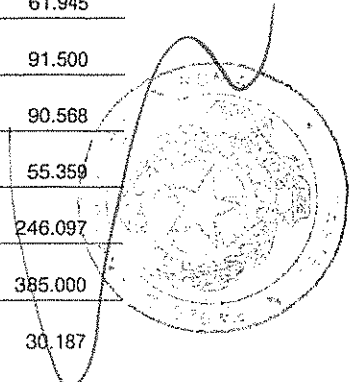

ASSEMBLEA ORDINARIA

81607/236 12 MAGGIO 2016

Segreteria Societaria - Ufficio Titoli



eni

Unica convocazione

Esito della votazione sul punto 2

Attribuzione dell'utile di esercizio

Elenco Favorevoli

SCHEDA	VPC	NOMINATIVO AZIONISTA	DELEGATO	NUMERO DI AZIONI TOTALE
659		SOUTHERN CALIFORNIA EDISON COMPANY RETIREMENT P	CARDARELLI ANGELO	137.658
720		SOUTHERN CALIFORNIA EDISON NUCLEAR FACILITIES CPUC DECOMMISSIONI	CARDARELLI ANGELO	60.448
2938		SOUTHERN COMPANY SYSTEM MASTER RETIREMEN	CARDARELLI ANGELO	593.895
856		SPARINVEST EUROPEAN VALUE	CARDARELLI ANGELO	35.605
857		SPARINVEST GLOBAL VALUE	CARDARELLI ANGELO	168.173
858		SPARINVEST POOL GLOBAL EQUITY	CARDARELLI ANGELO	152.505
1596		SPDR DJ EURO STOXX 50 ETF	CARDARELLI ANGELO	3.478.883
128		SPDR EUROPE PUBLIC LIMITED COMPANY	CARDARELLI ANGELO	10
1545		SPDR MSCI ACWI EX-US ETF	CARDARELLI ANGELO	114.397
1108		SPDR MSCI ACWI IMI ETF	CARDARELLI ANGELO	3.039
1109		SPDR MSCI EAFE QUALITY MIX ETF	CARDARELLI ANGELO	764
1110		SPDR MSCI WORLD QUALITY MIX ETF	CARDARELLI ANGELO	310
1546		SPDR S&P WORLD (EX-US) ETF	CARDARELLI ANGELO	103.709
1083		SPDR S+P GLOBAL NATURAL RESOURCES ETF	CARDARELLI ANGELO	550.124
1547		SPDR S+P INTERNATIONAL ENERGY SECTOR ETF	CARDARELLI ANGELO	95.726
1732		SPDR S+P WORLD EX AUSTRALIA FUND	CARDARELLI ANGELO	8.690
1595		SPDR STOXX EUROPE 50 ETF	CARDARELLI ANGELO	136.381
1327		SS BK AND TRUST COMPANY INV FUNDS FOR TAXEXEMPT RETIREMENT PL	CARDARELLI ANGELO	511.233
1329		SS BK AND TRUST COMPANY INV FUNDS FOR TAXEXEMPT RETIREMENT PL	CARDARELLI ANGELO	308.349
1331		SS BK AND TRUST COMPANY INV FUNDS FOR TAXEXEMPT RETIREMENT PL	CARDARELLI ANGELO	221.586
1332		SS BK AND TRUST COMPANY INV FUNDS FOR TAXEXEMPT RETIREMENT PL	CARDARELLI ANGELO	179.356
1336		SS BK AND TRUST COMPANY INV FUNDS FOR TAXEXEMPT RETIREMENT PL	CARDARELLI ANGELO	124.452
1338		SS BK AND TRUST COMPANY INV FUNDS FOR TAXEXEMPT RETIREMENT PL	CARDARELLI ANGELO	144.855

ASSEMBLEA ORDINARIA 12 MAGGIO 2016

Segreteria Societaria - Ufficio Titoli



Unica convocazione

Esito della votazione sul punto 2

Attribuzione dell'utile di esercizio

81607/1135

Z
M
C

Elenco Favorevoli

SCHEDA VPC	NOMINATIVO AZIONISTA	DELEGATO	NUMERO DI AZIONI TOTALE
1339	SS BK AND TRUST COMPANY INV FUNDS FOR TAXEXEMPT RETIREMENT PL	CARDARELLI ANGELO	4.527
1597	SS BK AND TRUST COMPANY INV FUNDS FOR TAXEXEMPT RETIREMENT PL	CARDARELLI ANGELO	5.053.506
1599	SS BK AND TRUST COMPANY INV FUNDS FOR TAXEXEMPT RETIREMENT PL	CARDARELLI ANGELO	2.185.325
1600	SS BK AND TRUST COMPANY INV FUNDS FOR TAXEXEMPT RETIREMENT PL	CARDARELLI ANGELO	2.309.859
1601	SS BK AND TRUST COMPANY INV FUNDS FOR TAXEXEMPT RETIREMENT PL	CARDARELLI ANGELO	86.907
1602	SS BK AND TRUST COMPANY INV FUNDS FOR TAXEXEMPT RETIREMENT PL	CARDARELLI ANGELO	3.991
1604	SS BK AND TRUST COMPANY INV FUNDS FOR TAXEXEMPT RETIREMENT PL	CARDARELLI ANGELO	335.358
1333	SSGA ACWI INTEGR ALPHA SELECT NON-LENDING QP COMMON TRUST F	CARDARELLI ANGELO	22.381
1340	SSGA ALL COUNTRY W EX-US INTEGR ALPHA SEL NON-LEND COMM TR F	CARDARELLI ANGELO	68.108
1330	SSGA EAFE INDEX PLUS NON-LENDING COMMON TRUST FUND	CARDARELLI ANGELO	11.515
1337	SSGA FTSE RAFI DEVELOPED 1000 INDEX NON-LENDING COMMON TR F	CARDARELLI ANGELO	111.252
1728	SSGA GLOBAL INDEX PLUS TRUST	CARDARELLI ANGELO	92.900
1737	SSGA GLOBAL MANAGED VOLATILITY ALPHA DSH TRUST	CARDARELLI ANGELO	24.065
2067	SSGA GROSS ROLL UP UNIT TRUST	CARDARELLI ANGELO	61.895
1730	SSGA INTERNATIONAL EQUITIES INDEX TRUST	CARDARELLI ANGELO	143.704
1487	SSGA INTERNATIONAL STOCK SELECTION FUND	CARDARELLI ANGELO	383.638
1213	SSGA MSCI ACWI EX-USA INDEX NON-LENDING DAILY TRUST	CARDARELLI ANGELO	59.137
1575	SSGA MSCI EAFE INDEX FUND	CARDARELLI ANGELO	119.590
1341	SSGA MSCI EUROPE SCREENED INDEX NON-LENDING COMMON TRUST FUND	CARDARELLI ANGELO	230.724
1334	SSGA RUSSELL FD GL EX-US INDEX NONLENDING QP COMMON TRUST FUND	CARDARELLI ANGELO	91.402
1335	SSGA S+P GLB LARGEMIDCAP NAT RES INDEX NON-LEND QP COMM TR F	CARDARELLI ANGELO	162.383
1223	SSGA SPDR ETFS EUROPE I PUBLIC LIMITED COMPANY	CARDARELLI ANGELO	39.034
1224	SSGA SPDR ETFS EUROPE I PUBLIC LIMITED COMPANY	CARDARELLI ANGELO	1.214

Z
M
C

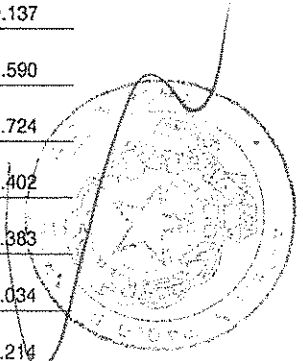

ASSEMBLEA ORDINARIA

81607/436 12 MAGGIO 2016

Segreteria Societaria - Ufficio Titoli



eni

Unica convocazione

Esito della votazione sul punto 2

Attribuzione dell'utile di esercizio

Elenco Favorevoli

SCHEDA	VPC	NOMINATIVO AZIONISTA	DELEGATO	NUMERO DI AZIONI TOTALE
1225		SSGA SPDR ETFS EUROPE I PUBLIC LIMITED COMPANY	CARDARELLI ANGELO	157.541
1226		SSGA SPDR ETFS EUROPE II PUBLIC LIMITED COMPANY	CARDARELLI ANGELO	1.877
1227		SSGA SPDR ETFS EUROPE II PUBLIC LIMITED COMPANY	CARDARELLI ANGELO	221.798
1228		SSGA SPDR ETFS EUROPE II PUBLIC LIMITED COMPANY	CARDARELLI ANGELO	181.675
1229		SSGA SPDR ETFS EUROPE II PUBLIC LIMITED COMPANY	CARDARELLI ANGELO	27.297
1926		ST. JOSEPH HEALTH SYSTEM	CARDARELLI ANGELO	8.414
433		ST. SPOORWEGPFDS MANDAAT BLACKROCK	CARDARELLI ANGELO	38.455
312		STANLIB FUNDS LIMITED STANDARD BANK HOUSE	CARDARELLI ANGELO	55.059
3296		STAR FUND	CARDARELLI ANGELO	1.500.000
1525		STATE BOSTON RETIREMENT SYSTEM	CARDARELLI ANGELO	70.787
1077		STATE FARM MUTUAL FUND TRUST, INTERNATIONAL INDEX FUND	CARDARELLI ANGELO	51.888
865		STATE FARM VARIABLE PRODUCT TRUST, INTERNATIONAL EQ INDEX F	CARDARELLI ANGELO	57.493
1506		STATE OF ALASKA RETIREMENT AND BENEFITS PLANS	CARDARELLI ANGELO	1.374.589
1507		STATE OF ALASKA RETIREMENT AND BENEFITS PLANS	CARDARELLI ANGELO	101.371
2985		STATE OF CALIFORNIA MASTER TRUST	CARDARELLI ANGELO	113.135
1531		STATE OF MINNESOTA	CARDARELLI ANGELO	628.516
1532		STATE OF MINNESOTA	CARDARELLI ANGELO	26.948
1555		STATE OF NEBRASKA	CARDARELLI ANGELO	13.850
665		STATE OF WISCONSIN INVESTMENT BOARD	CARDARELLI ANGELO	148.421
666		STATE OF WISCONSIN INVESTMENT BOARD	CARDARELLI ANGELO	1.305.000
667		STATE OF WISCONSIN INVESTMENT BOARD	CARDARELLI ANGELO	145.000
668		STATE OF WISCONSIN INVESTMENT BOARD	CARDARELLI ANGELO	1.903.815
669		STATE OF WISCONSIN INVESTMENT BOARD	CARDARELLI ANGELO	149.550

ASSEMBLEA ORDINARIA 12 MAGGIO 2016

Segreteria Societaria - Ufficio Titoli



Unica convocazione

Esito della votazione sul punto 2

Attribuzione dell'utile di esercizio

81607/1137

Elenco Favorevoli

SCHEDA	VPC	NOMINATIVO AZIONISTA	DELEGATO	NUMERO DI AZIONI TOTALE
3080		STATE OF WYOMING	CARDARELLI ANGELO	127.684
1740		STATE PUBLIC SECTOR SUPERANNUATION SCHEME	CARDARELLI ANGELO	23.006
1741		STATE PUBLIC SECTOR SUPERANNUATION SCHEME	CARDARELLI ANGELO	178.899
1742		STATE PUBLIC SECTOR SUPERANNUATION SCHEME	CARDARELLI ANGELO	10.421
1743		STATE PUBLIC SECTOR SUPERANNUATION SCHEME	CARDARELLI ANGELO	57.413
1345		STATE STREET GLOBAL ADVISORS LUXEMBOURG SICAV	CARDARELLI ANGELO	63.483
1346		STATE STREET GLOBAL ADVISORS LUXEMBOURG SICAV	CARDARELLI ANGELO	728.742
1347		STATE STREET GLOBAL ADVISORS LUXEMBOURG SICAV	CARDARELLI ANGELO	8.732
1348		STATE STREET GLOBAL ADVISORS LUXEMBOURG SICAV	CARDARELLI ANGELO	17.738
1349		STATE STREET GLOBAL ADVISORS LUXEMBOURG SICAV	CARDARELLI ANGELO	6.108
1350		STATE STREET GLOBAL ADVISORS LUXEMBOURG SICAV	CARDARELLI ANGELO	58.425
1351		STATE STREET GLOBAL ADVISORS LUXEMBOURG SICAV	CARDARELLI ANGELO	14.049
1352		STATE STREET GLOBAL ADVISORS LUXEMBOURG SICAV	CARDARELLI ANGELO	10.794
1353		STATE STREET GLOBAL ADVISORS LUXEMBOURG SICAV	CARDARELLI ANGELO	11.882
1098		STATE STREET GLOBAL EQUITY EX-US INDEX PORTFOLIO	CARDARELLI ANGELO	22.166
1220		STATE STREET IRELAND UNIT TRUST	CARDARELLI ANGELO	437.874
1232		STATE STREET IRELAND UNIT TRUST	CARDARELLI ANGELO	29.737
1233		STATE STREET IRELAND UNIT TRUST	CARDARELLI ANGELO	45.019
1234		STATE STREET IRELAND UNIT TRUST	CARDARELLI ANGELO	63.514
1673		STATE STREET TRUSTEES LTD ATF ABERDEEN CAPITAL TRUST	CARDARELLI ANGELO	58.289
2840		STATE SUPER FINANCIAL SERVICES AUSTRALIA LIMITED AS TRUSTEE FOR THE INT EQ SECT TRUST	CARDARELLI ANGELO	90.025
57		STATE TEACHERS RETIREMENT SYSTEM	CARDARELLI ANGELO	1.059.801
1985		STATE UNIVERSITIES RETIREMENT SYSTEM	CARDARELLI ANGELO	49.378

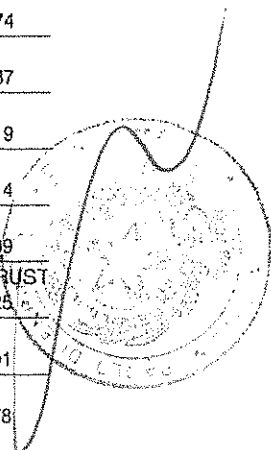

ASSEMBLEA ORDINARIA

81607/1138 12 MAGGIO 2016

Segreteria Societaria - Ufficio Titoli



eni

Unica convocazione

Esito della votazione sul punto 2

Attribuzione dell'utile di esercizio

Elenco Favorevoli

SCHEDA	VPC	NOMINATIVO AZIONISTA	DELEGATO	NUMERO DI AZIONI TOTALE
1804		STATES OF JERSEY COMMON INVESTMENT FUND	CARDARELLI ANGELO	17.171
2649		STAUBLI 50 50 CREDIT MUTUEL FCPE	CARDARELLI ANGELO	5.000
2648		STAUBLI 80 20 CREDIT MUTUEL FCPE	CARDARELLI ANGELO	5.000
438		STG BEDRIJFSTAKPFDS V H	CARDARELLI ANGELO	31.132
439		STG BPF VD DETAILHANDEL MND BLACKROCK MSCI EMEA	CARDARELLI ANGELO	417.057
430		STG BPF VOOR HET LEVENSMID. BEDRIJF IPM	CARDARELLI ANGELO	216.303
436		STG PFDS ACHMEA MANDAAT BLACKROCK	CARDARELLI ANGELO	126.611
432		STG PFDS AHOLD	CARDARELLI ANGELO	160.139
429		STG PFDS CORP EXPRESS MANDAAT ALLIANCE CAPITA	CARDARELLI ANGELO	15.894
431		STG PFDS V.D. GRAFISCHE	CARDARELLI ANGELO	843.897
2435		STICHT BEDRIJ MEDIA PNO	CARDARELLI ANGELO	58.600
2969		STICHTING ALGEMEEN PENSIOENFONDS PROVISU	CARDARELLI ANGELO	46.186
3039		STICHTING ASR BEWAARDER	CARDARELLI ANGELO	88.131
3265		STICHTING ASR BEWAARDER	CARDARELLI ANGELO	302.856
2089		STICHTING BEDRIJFST VOOR HET BEROEPSVERVOER OVER DE WEG	CARDARELLI ANGELO	497.927
2090		STICHTING BEDRIJFST VOOR HET BEROEPSVERVOER OVER DE WEG	CARDARELLI ANGELO	48.781
2091		STICHTING BEDRIJFST VOOR HET BEROEPSVERVOER OVER DE WEG	CARDARELLI ANGELO	54.490
2092		STICHTING BEDRIJFST VOOR HET BEROEPSVERVOER OVER DE WEG	CARDARELLI ANGELO	137.225
2093		STICHTING BEDRIJFST VOOR HET BEROEPSVERVOER OVER DE WEG	CARDARELLI ANGELO	125.103
375		STICHTING BEDRIJFSTAKPENSIOENFONDS VOOR HET SCHILDERS-AFWERKINGS-EN GLASZE	CARDARELLI ANGELO	372.517
378		STICHTING BEWAARDER ACHMEA BELEGGIN GSPOOLS	CARDARELLI ANGELO	111.527
377		STICHTING BEWAARDER ACHMEA BELEGGINGSPOLS	CARDARELLI ANGELO	118.780
2094		STICHTING DELA DEPOSITARY AND MANAGEMENT	CARDARELLI ANGELO	208.884

ASSEMBLEA ORDINARIA 12 MAGGIO 2016

Segreteria Societaria - Ufficio Titoli



Unica convocazione

Esito della votazione sul punto 2

Attribuzione dell'utile di esercizio

81607/439

Elenco Favorevoli

SCHEDA	VPC	NOMINATIVO AZIONISTA	DELEGATO	NUMERO DI AZIONI TOTALE
2095		STICHTING DELA DEPOSITARY AND MANAGEMENT CARDARELLI ANGELO		210.678
832		STICHTING DEPOSITARY APG DEVELOPED MARKETS EQUITY POOL CARDARELLI ANGELO		3.654.216
833		STICHTING DEPOSITARY APG DEVELOPED MARKETS EQUITY POOL CARDARELLI ANGELO		3.397.760
835		STICHTING DEPOSITARY APG DEVELOPED MARKETS EQUITY POOL CARDARELLI ANGELO		736.800
836		STICHTING DEPOSITARY APG DEVELOPED MARKETS EQUITY POOL CARDARELLI ANGELO		2.356.281
837		STICHTING DEPOSITARY APG DEVELOPED MARKETS EQUITY POOL CARDARELLI ANGELO		295.637
838		STICHTING DEPOSITARY APG DEVELOPED MARKETS EQUITY POOL CARDARELLI ANGELO		392.177
2087		STICHTING DOUWE EGBERTS PENSIOENFONDS CARDARELLI ANGELO		89.853
426		STICHTING DOW PENSIOENFONDS CARDARELLI ANGELO		240.316
1700		STICHTING F AND C MULTI MANAGER EUROPEAN EQUITY ACTIVE CARDARELLI ANGELO		168.472
1701		STICHTING F AND C MULTI MANAGER EUROPEAN EQUITY ACTIVE CARDARELLI ANGELO		10.742
2022		STICHTING HEINEKEN PENSIOENFONDS CARDARELLI ANGELO		446.556
1962		STICHTING INSTITUUT GAK CARDARELLI ANGELO		12.005
1963		STICHTING INSTITUUT GAK CARDARELLI ANGELO		8.193
452		STICHTING MARS PENSIOENFONDS CARDARELLI ANGELO		10.498
36		STICHTING MN SERVICES AANDELENFONDS EUROPA. CARDARELLI ANGELO		251.219
834		STICHTING PENSIOENFONDS ABP CARDARELLI ANGELO		2.738.274
2026		STICHTING PENSIOENFONDS APF CARDARELLI ANGELO		25.074
2027		STICHTING PENSIOENFONDS APF CARDARELLI ANGELO		189.800
2088		STICHTING PENSIOENFONDS CAMPINA CARDARELLI ANGELO		25.240
437		STICHTING PENSIOENFONDS CARIBISCH CARDARELLI ANGELO		14.508
400		STICHTING PENSIOENFONDS HORECA & CATERING CARDARELLI ANGELO		243.211
2034		STICHTING PENSIOENFONDS IBM NEDERLAND CARDARELLI ANGELO		26.170

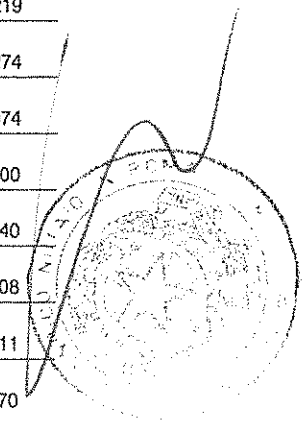

ASSEMBLEA ORDINARIA

81607/1460 12 MAGGIO 2016

Segreteria Societaria - Ufficio Titoli



eni

Unica convocazione

Esito della votazione sul punto 2

Attribuzione dell'utile di esercizio

Elenco Favorevoli

SCHEDA	VPC	NOMINATIVO AZIONISTA	DELEGATO	NUMERO DI AZIONI TOTALE
2096		STICHTING PENSIOENFONDS ING	CARDARELLI ANGELO	300.194
2976		STICHTING PENSIOENFONDS MEDISCH SPECIALI	CARDARELLI ANGELO	122.927
24		STICHTING PENSIOENFONDS METAAL	CARDARELLI ANGELO	1.005.809
67		STICHTING PENSIOENFONDS METAAL EN T MN SERVICES	CARDARELLI ANGELO	90.792
434		STICHTING PENSIOENFONDS OPENBAAR VERVOER	CARDARELLI ANGELO	18.419
2023		STICHTING PENSIOENFONDS SAGITTARIUS	CARDARELLI ANGELO	96.036
350		STICHTING PENSIOENFONDS UNILEVER NEDERLAND PROGRESS	CARDARELLI ANGELO	290.000
399		STICHTING PENSIOENFONDS UWV	CARDARELLI ANGELO	299.019
366		STICHTING PENSIOENFONDS VAN DE ABN AMRO BANK N.V.	CARDARELLI ANGELO	529.924
367		STICHTING PENSIOENFONDS VAN DE ABN AMRO BANK N.V.	CARDARELLI ANGELO	180.710
368		STICHTING PENSIOENFONDS VAN DE ABN AMRO BANK N.V.	CARDARELLI ANGELO	460.031
369		STICHTING PENSIOENFONDS VAN DE ABN AMRO BANK N.V.	CARDARELLI ANGELO	297.324
2035		STICHTING PENSIOENFONDS VAN DE METALEKTRO (PME)	CARDARELLI ANGELO	1.183.844
2036		STICHTING PENSIOENFONDS VAN DE METALEKTRO (PME)	CARDARELLI ANGELO	498.524
2037		STICHTING PENSIOENFONDS VAN DE METALEKTRO (PME)	CARDARELLI ANGELO	190.444
305		STICHTING PENSIOENFONDS VAN DE NEDERLANDSCHE BANK NV	CARDARELLI ANGELO	34.466
62		STICHTING PENSIOENFONDS VOOR DE GRADEMIR	CARDARELLI ANGELO	173.688
44		STICHTING PGGM DEPOSITARY	CARDARELLI ANGELO	1.865.523
1709		STICHTING PHILIPS PENSIOENFONDS	CARDARELLI ANGELO	427.083
385		STICHTING RABOBANK PENSIOENFONDS	CARDARELLI ANGELO	213.555
386		STICHTING RABOBANK PENSIOENFONDS	CARDARELLI ANGELO	1.089.443
2968		STICHTING SHELL PENSIOENFONDS	CARDARELLI ANGELO	12.523
2970		STICHTING SHELL PENSIOENFONDS	CARDARELLI ANGELO	146.731

ASSEMBLEA ORDINARIA 12 MAGGIO 2016

Segreteria Societaria - Ufficio Titoli



eni

81607/1161

Unica convocazione

Esito della votazione sul punto 2

Attribuzione dell'utile di esercizio

Elenco Favorevoli

SCHEDA	VPC	NOMINATIVO AZIONISTA	DELEGATO	NUMERO DI AZIONI TOTALE
1702		STICHTING TRUST F AND C UNHEDGE	CARDARELLI ANGELO	81.417
1817		STRATEGIC INVESTMENT MANAGEMENT INTERNATIONAL EQUITY TRUST	CARDARELLI ANGELO	17.582
2029		STRATHCLYDE PENSION FUND	CARDARELLI ANGELO	1.833.843
120		STRUCTURA EQUITY GLOBAL RESTRUCTURING	CARDARELLI ANGELO	14.438
222		SUBSIDIZED SCHOOLS PROVIDENT FUND	CARDARELLI ANGELO	53.144
2583		SUEWE COFONDS	CARDARELLI ANGELO	50.000
2062		SUMMIT INVESTMENT FUNDS PLC	CARDARELLI ANGELO	43.242
2063		SUMMIT INVESTMENT FUNDS PLC	CARDARELLI ANGELO	90.090
2060		SUMMIT MUTUAL FUNDS PUBLIC LIMITED COMPANY	CARDARELLI ANGELO	14.024
2061		SUMMIT MUTUAL FUNDS PUBLIC LIMITED COMPANY	CARDARELLI ANGELO	60.220
1719		SUN LIFE ASSURANCE COMPANY OF CANADA (U.K.) LIMITED	CARDARELLI ANGELO	24.129
1720		SUN LIFE ASSURANCE COMPANY OF CANADA (U.K.) LIMITED	CARDARELLI ANGELO	235.323
1721		SUN LIFE ASSURANCE COMPANY OF CANADA (U.K.) LIMITED	CARDARELLI ANGELO	85.611
1722		SUN LIFE ASSURANCE COMPANY OF CANADA (U.K.) LIMITED	CARDARELLI ANGELO	333.558
3147		SUN LIFE MFS LOW VOLATILY INTERNATION	CARDARELLI ANGELO	13.825
1091		SUNAMERICA SERIES TRUST FOREIGN VALUE PORTFOLIO	CARDARELLI ANGELO	907.015
1092		SUNAMERICA SERIES TRUST INT DIVERSIFIED EQ PTF	CARDARELLI ANGELO	110.465
1094		SUNAMERICA SERIES TRUST- SA BLACKROCK VCP GLO MUL ASSET PTF	CARDARELLI ANGELO	4.456
1235		SUNSUPER SUPERANNUATION FUND	CARDARELLI ANGELO	79.318
1745		SUNSUPER SUPERANNUATION FUND	CARDARELLI ANGELO	7.139
1746		SUNSUPER SUPERANNUATION FUND	CARDARELLI ANGELO	216.285
1747		SUNSUPER SUPERANNUATION FUND	CARDARELLI ANGELO	143.423
2871		SUPER FUNDS MANAG CORP SOUTH AUSTRALIA	CARDARELLI ANGELO	481.124

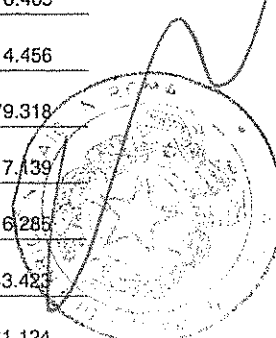

ASSEMBLEA ORDINARIA81607/142 **12 MAGGIO 2016**

Segreteria Societaria - Ufficio Titoli

**eni**

Unica convocazione

Esito della votazione sul punto 2

Attribuzione dell'utile di esercizio**Elenco Favorevoli**

SCHEDA	VPC NOMINATIVO AZIONISTA	DELEGATO	NUMERO DI AZIONI TOTALE
2901	SUPERANNUATION FUNDS MANAGEMENT CORPORATION OF SOUTH AUSTRALIA CARDARELLI ANGELO		57.709
1236	SUPERVALU INC. MASTER INVESTMENT TRUST CARDARELLI ANGELO		10.618
2547	SVCO III FONDS CARDARELLI ANGELO		15.000
3276	SWISS NATIONAL BANK CARDARELLI ANGELO		16.910.512
2857	SWISS REINSURANCE COMPANY LTD CARDARELLI ANGELO		398.191
2738	SWISSCANTO (LU) EQUITY FUND CARDARELLI ANGELO		85.000
2739	SWISSCANTO SMART CORE CARDARELLI ANGELO		6.513
874	SYLVAN PARTNERS, LLC CARDARELLI ANGELO		9.749
348	SYNGENTA UK PENSION FUND EUROPEAN REGIONAL CENTRE CARDARELLI ANGELO		87.875
2653	Score saint Nicolas CARDARELLI ANGELO		8.000
2946	T ROWE CONCENTRATED INTERNAT EQUITY FUND CARDARELLI ANGELO		241.734
2940	T ROWE PRICE INTERNATIONAL EQUITY INDEX CARDARELLI ANGELO		93.447
2756	T. ROWE PRICE FUNDS SICAV CARDARELLI ANGELO		196.826
2757	T. ROWE PRICE FUNDS SICAV CARDARELLI ANGELO		709.452
3060	T. ROWE PRICE GLOBAL EQUITY FUND CARDARELLI ANGELO		3.056
2924	T. ROWE PRICE INT INC. EUROPEAN STOCK FU CARDARELLI ANGELO		1.352.043
2927	T. ROWE PRICE INTERNATIONAL CONCENTRATED CARDARELLI ANGELO		10.510
1074	TANGERINE BALANCED GROWTH PORTFOLIO CARDARELLI ANGELO		26.055
1072	TANGERINE BALANCED INCOME PORTFOLIO CARDARELLI ANGELO		4.672
1073	TANGERINE BALANCED PORTFOLIO CARDARELLI ANGELO		28.243
1075	TANGERINE EQUITY GROWTH PORTFOLIO CARDARELLI ANGELO		15.608
1859	TANYA AND CHARLES BRANDES FOUNDATION CARDARELLI ANGELO		9.800
670	TD EMERALD INTERNATIONAL EQUITYINDEX FUND CARDARELLI ANGELO		568.304

ASSEMBLEA ORDINARIA 12 MAGGIO 2016

Segreteria Societaria - Ufficio Titoli



eni

[Handwritten signature]

81607/443

Unica convocazione

Esito della votazione sul punto 2

Attribuzione dell'utile di esercizio

Elenco Favorevoli

SCHEDA	VPC	NOMINATIVO AZIONISTA	DELEGATO	NUMERO DI AZIONI TOTALE
675	TD EUROPEAN INDEX FUND .		CARDARELLI ANGELO	18.940
676	TD INTERNATIONAL EQUITY INDEX ETF		CARDARELLI ANGELO	1.116
673	TD INTERNATIONAL GROWTH FUND		CARDARELLI ANGELO	326.018
671	TD RESOURCE FUND		CARDARELLI ANGELO	314.000
672	TD STRATEGIC YIELD FUND		CARDARELLI ANGELO	100.000
1242	TEACHER RETIREMENT SYSTEM OF TEXAS		CARDARELLI ANGELO	54.136
1248	TEACHER RETIREMENT SYSTEM OF TEXAS		CARDARELLI ANGELO	159.239
1249	TEACHER RETIREMENT SYSTEM OF TEXAS		CARDARELLI ANGELO	399.389
1250	TEACHER RETIREMENT SYSTEM OF TEXAS		CARDARELLI ANGELO	256.509
1251	TEACHER RETIREMENT SYSTEM OF TEXAS		CARDARELLI ANGELO	369.693
1582	TEACHER RETIREMENT SYSTEM OF TEXAS		CARDARELLI ANGELO	885.704
1583	TEACHER RETIREMENT SYSTEM OF TEXAS		CARDARELLI ANGELO	900.000
1584	TEACHER RETIREMENT SYSTEM OF TEXAS		CARDARELLI ANGELO	73.819
1585	TEACHER RETIREMENT SYSTEM OF TEXAS		CARDARELLI ANGELO	1.173.485
1586	TEACHER RETIREMENT SYSTEM OF TEXAS		CARDARELLI ANGELO	5.661
685	TEACHERS' RETIREMENT ALLOWANCES FUND		CARDARELLI ANGELO	33.240
2843	TEACHERS' RETIREMENT SYSTEM OF THE CITY OF NEW YORK		CARDARELLI ANGELO	72.892
1478	TEACHERS' RETIREMENT SYSTEM OF THE STATE OF ILLINOIS		CARDARELLI ANGELO	1.079.429
1479	TEACHERS' RETIREMENT SYSTEM OF THE STATE OF ILLINOIS		CARDARELLI ANGELO	362.914
1986	TEACHERS'S RETIREMENT SYSTEM OF OKLAHOMA		CARDARELLI ANGELO	165.627
738	TELEDYNE TECHNOLOGIES INC DEFINED BENEFIT MASTER TRUST		CARDARELLI ANGELO	9.190
2863	TELSTRA SUPERANNUATION SCHEME		CARDARELLI ANGELO	388.551
679	TELUS PENSIONS MASTER TRUST		CARDARELLI ANGELO	137.772

[Handwritten signature]

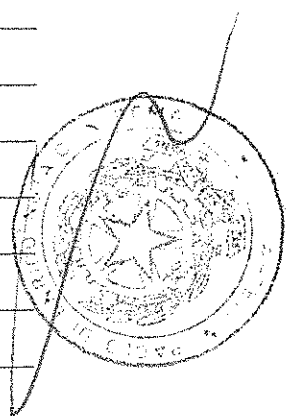

ASSEMBLEA ORDINARIA

81607 *Luigi* 12 MAGGIO 2016

Segreteria Societaria - Ufficio Titoli



eni

Unica convocazione

Esito della votazione sul punto 2

Attribuzione dell'utile di esercizio

Elenco Favorevoli

SCHEDA	VPC	NOMINATIVO AZIONISTA	DELEGATO	NUMERO DI AZIONI TOTALE
2904		TEMPLETON EAFE DEVELOPED MARKETS FUND	CARDARELLI ANGELO	237.962
2856		TEMPLETON EX-JAPAN GLOBAL EQUITY FUND LT	CARDARELLI ANGELO	7.142
2921		TEMPLETON FOREIGN FUND	CARDARELLI ANGELO	4.133.610
2895		TEMPLETON GLOBAL EQUITY TRUST	CARDARELLI ANGELO	554.245
2887		TEMPLETON GLOBAL GROWTH FUND LIMITED	CARDARELLI ANGELO	116.123
251		TEMPLETON GLOBAL INVESTMENT TRUST-TEMPLETON GLOBAL BALANCED FUND	CARDARELLI ANGELO	1.582.500
2923		TEMPLETON GLOBAL OPPORTUNITIES TRUST	CARDARELLI ANGELO	205.165
2884		TEMPLETON GLOBAL STOCK TRUST	CARDARELLI ANGELO	293.700
2885		TEMPLETON GLOBAL TRUST FUND	CARDARELLI ANGELO	90.375
2847		TEMPLETON GROWTH FUND II LIMITED	CARDARELLI ANGELO	5.332
2984		TEMPLETON GROWTH FUND INC.	CARDARELLI ANGELO	6.671.477
309		TEMPLETON GROWTH FUND ISS 88 FRANKLIN TEMPLETON	CARDARELLI ANGELO	129.563
2883		TEMPLETON GROWTH FUND, LTD.	CARDARELLI ANGELO	638.150
2925		TEMPLETON INSTITUTIONAL FUNDS - FOREIGN	CARDARELLI ANGELO	3.112.092
2930		TEMPLETON INSTITUTIONAL FUNDS - GLOBAL E	CARDARELLI ANGELO	184.797
2894		TEMPLETON INTERNATIONAL EQUITY TRUST	CARDARELLI ANGELO	209.548
3097		TEMPLETON INTERNATIONAL FOREIGN FUND	CARDARELLI ANGELO	797.810
2897		TEMPLETON INTERNATIONAL STOCK FUND	CARDARELLI ANGELO	421.942
2892		TEMPLETON INTERNATIONAL STOCK TRUST.	CARDARELLI ANGELO	159.021
2891		TEMPLETON MASTER TRUST - SERIES 1	CARDARELLI ANGELO	213.477
2890		TEMPLETON MASTER TRUST - SERIES 2	CARDARELLI ANGELO	27.821
2947		TEMPLETON NVIT INTERNATIONAL VALUE FUND	CARDARELLI ANGELO	133.715
2920		TEMPLETON WORLD FUND	CARDARELLI ANGELO	3.695.594

ASSEMBLEA ORDINARIA 12 MAGGIO 2016

Segreteria Societaria - Ufficio Titoli



eni

M

81607/M45

Unica convocazione

Esito della votazione sul punto 2

Attribuzione dell'utile di esercizio

Elenco Favorevoli

SCHEDA VPC	NOMINATIVO AZIONISTA	DELEGATO	NUMERO DI AZIONI TOTALE
1247	TENNESSEE CONSOLIDATED RETIREMENT SYSTEM CARDARELLI ANGELO		96.292
690	TENNESSEE VALLEY AUTHORITY RETIREMENT SYSTEM CARDARELLI ANGELO		29.878
684	TEXAS EDUCATION AGENCY . CARDARELLI ANGELO		673.656
1139	TEXAS MUNICIPAL RETIREMENT SYSTEM CARDARELLI ANGELO		286.053
2971	TFL PENSION FUND CARDARELLI ANGELO		626.657
931	THE ALLIANCEBERNSTEIN POOLING PTF - ALLIANCEB VOL MNGM PTF CARDARELLI ANGELO		67.672
930	THE ALLIANCEBERNSTEIN POOLING PTF-ALLIANCEBR MULTASS REAL RTP CARDARELLI ANGELO		8.206
268	THE BANK OF KOREA CARDARELLI ANGELO		45.549
269	THE BANK OF KOREA CARDARELLI ANGELO		111.184
270	THE BANK OF KOREA CARDARELLI ANGELO		92.199
277	THE BANK OF KOREA CARDARELLI ANGELO		86.395
280	THE BANK OF KOREA CARDARELLI ANGELO		129.968
2977	THE BARCLAYS BANK UK RETIREMENT FUND CARDARELLI ANGELO		6.869
2001	THE BARING MULTI ASSET F, A SUBF BARING MULTI ASSET INV F CARDARELLI ANGELO		20.790
495	THE BOARD OF PENSIONS OF THE PRESBYTERIAN CHURCH CARDARELLI ANGELO		210.159
2869	THE BOEING COMPANY EMPLOYEE RETIREMENT P CARDARELLI ANGELO		919.951
2872	THE BOEING COMPANY EMPLOYEE RETIREMENT P CARDARELLI ANGELO		23.720
1034	THE BOEING COMPANY EMPLOYEE SAVINGS PLANS MASTER TRUST CARDARELLI ANGELO		115.191
3254	THE BOMBARDIER TRUST (UK) CARDARELLI ANGELO		31.716
2975	THE BRITISH STEEL PENSION SCHEME CARDARELLI ANGELO		473.621
502	THE CANADA LIFE ASSURANCE COMPANY CARDARELLI ANGELO		118.984
503	THE CANADA LIFE ASSURANCE COMPANY CARDARELLI ANGELO		31.453
504	THE CANADA LIFE ASSURANCE COMPANY CARDARELLI ANGELO		16.508

M

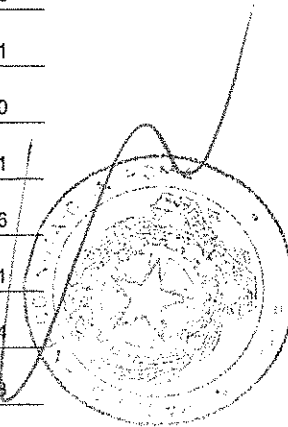

ASSEMBLEA ORDINARIA

31607/2046 12 MAGGIO 2016

Segreteria Societaria - Ufficio Titoli



eni

Unica convocazione

Esito della votazione sul punto 2

Attribuzione dell'utile di esercizio

Elenco Favorevoli

SCHEDA	VPC	NOMINATIVO AZIONISTA	DELEGATO	NUMERO DI AZIONI TOTALE
505		THE CANADA LIFE ASSURANCE COMPANY	CARDARELLI ANGELO	25.161
518		THE CHRYSLER CANADA INC.CANADIAN MASTER TRUST FUND	CARDARELLI ANGELO	60.864
498		THE CLEVELAND CLINIC FOUNDATION	CARDARELLI ANGELO	6.342
740		THE DUN AND BRADSTREET CORP DEFINED BENEFIT GROUP TRUST	CARDARELLI ANGELO	18.796
2049		THE EUROPEAN INVESTMENT TRUST PLC	CARDARELLI ANGELO	1.035.495
1042		THE GABELLI GLOBAL UTILITY & INCOME TRUST	CARDARELLI ANGELO	1.000
908		THE GEORGE PUTNAM FUND OF BOSTON	CARDARELLI ANGELO	141.654
729		THE GEORGE WASHINGTON UNIVERSITY	CARDARELLI ANGELO	7.897
1843		THE GRAUSTEIN TRUSTS PARTNERSHIP	CARDARELLI ANGELO	1.093
3249		THE GREAT-WEST LIFE ASSURANCE COMPAN	CARDARELLI ANGELO	137.285
553		THE GREAT-WEST LIFE ASSURANCE COMPANY	CARDARELLI ANGELO	40.737
554		THE GREAT-WEST LIFE ASSURANCE COMPANY	CARDARELLI ANGELO	19.036
556		THE GREAT-WEST LIFE ASSURANCE COMPANY	CARDARELLI ANGELO	14.475
1057		THE HARTFORD GLOBAL ALL- ASSET FUND	CARDARELLI ANGELO	10.560
1056		THE HARTFORD GLOBAL REAL ASSET FUND	CARDARELLI ANGELO	232.012
1052		THE HARTFORD INTERNATIONAL GROWTH FUND	CARDARELLI ANGELO	96.031
1053		THE HARTFORD INTERNATIONAL OPPORTUNITIES FUND	CARDARELLI ANGELO	892.625
1055		THE HARTFORD INTERNATIONAL VALUE FUND	CARDARELLI ANGELO	1.012.453
558		THE HARTFORD ROMAN CATHOLIC DIOCESAN CORP RET PL	CARDARELLI ANGELO	1.215
1760		THE HEALTH FOUNDATION	CARDARELLI ANGELO	177.887
454		THE HEARST CORPORATION MASTER TRUST FOR PENSION E PROFIT SHARING	CARDARELLI ANGELO	35.438
2881		THE INVESTMENT COMPANY OF AMERICA	CARDARELLI ANGELO	14.538.061
1844		THE J BUT MASTER INVESTMENT PARTNERSHIP LLP	CARDARELLI ANGELO	5.836

ASSEMBLEA ORDINARIA 12 MAGGIO 2016

Segreteria Societaria - Ufficio Titoli



eni

81607/1147

Unica convocazione

Esito della votazione sul punto 2

Attribuzione dell'utile di esercizio

Elenco Favorevoli

SCHEDA	VPC	NOMINATIVO AZIONISTA	DELEGATO	NUMERO DI AZIONI TOTALE
1910		THE LEVERHULME TRUST	CARDARELLI ANGELO	16.409
1959		THE LILLY RETIREMENT PLAN MASTER TRUST	CARDARELLI ANGELO	40.768
576		THE MANUFACTURERS LIFE INSURANCE COMPANY	CARDARELLI ANGELO	146.897
453		THE MARS ASSOCIATES' RETIREMENTPLAN	CARDARELLI ANGELO	64.453
972		THE MASTER TR BK OF JP LTD ATF INVESCO DEV COUNT EQ INDEX M F	CARDARELLI ANGELO	257
3061		THE MASTER TRUST BANK OF JAPAN	CARDARELLI ANGELO	13.980
2962		THE MASTER TRUST BANK OF JAPAN LTD	CARDARELLI ANGELO	2.965.924
2963		THE MASTER TRUST BANK OF JAPAN LTD	CARDARELLI ANGELO	2.971.186
2982		THE MASTER TRUST BANK OF JAPAN LTD	CARDARELLI ANGELO	2.900.845
2359		THE MASTER TRUST BANK OF JAPAN LTD	CARDARELLI ANGELO	12.000
2360		THE MASTER TRUST BANK OF JAPAN LTD	CARDARELLI ANGELO	77.228
2374		THE MASTER TRUST BANK OF JAPAN LTD	CARDARELLI ANGELO	40.348
2375		THE MASTER TRUST BANK OF JAPAN LTD	CARDARELLI ANGELO	2.840
2376		THE MASTER TRUST BANK OF JAPAN LTD	CARDARELLI ANGELO	7.964
2386		THE MASTER TRUST BANK OF JAPAN LTD	CARDARELLI ANGELO	30.153
2394		THE MASTER TRUST BANK OF JAPAN LTD	CARDARELLI ANGELO	4.206
2413		THE MASTER TRUST BANK OF JAPAN LTD	CARDARELLI ANGELO	18.062
2419		THE MASTER TRUST BANK OF JAPAN LTD	CARDARELLI ANGELO	14.000
2964		THE MASTER TRUST BANK OF JAPAN, LTD AS TRUSTEE FOR MUTB400045796	CARDARELLI ANGELO	2.954.336
2979		THE MASTER TRUST BANK OF JAPAN, LTD. AS TRUSTEE FOR MUTB400045792	CARDARELLI ANGELO	3.007.995
942		THE MASTER TRUST BK OF JP LTD: HITACHI FOREIGN EQ INDEX MF	CARDARELLI ANGELO	52.596
974		THE MASTER TRUST BK OF JP RE F RUSSELL INV (JP) INTL EQUITY F	CARDARELLI ANGELO	62.540
462		THE MEDICAL CENTRE INSURANCE COMPANY LTD.	CARDARELLI ANGELO	24.940

mm

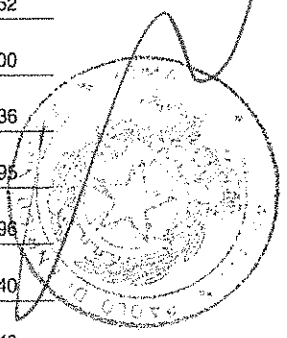

ASSEMBLEA ORDINARIA

81607/448 12 MAGGIO 2016

Segreteria Societaria - Ufficio Titoli



eni

Unica convocazione

Esito della votazione sul punto 2

Attribuzione dell'utile di esercizio

Elenco Favorevoli

SCHEDA	VPC	NOMINATIVO AZIONISTA	DELEGATO	NUMERO DI AZIONI TOTALE
3171		THE METHODIST CHURCH IN IRELAND EQ FUND	CARDARELLI ANGELO	20.300
860		THE METHODIST HOSPITAL	CARDARELLI ANGELO	82.735
1852		THE NEW YORK TIMES COMPANY PENSION TRUST	CARDARELLI ANGELO	21.353
38		THE NOMURA TRUST AND BANKING CO LTD	CARDARELLI ANGELO	52.336
39		THE NOMURA TRUST AND BANKING CO LTD	CARDARELLI ANGELO	2.250
456		THE NORTH CAROLINA SUPPLEMENTAL RETIREMENT PLANS GROUP TRUST	CARDARELLI ANGELO	437.537
1825		THE NORTHERN TRUST COMPANY SUB-ADVISED COLLECTIVE FUNDS TRUST	CARDARELLI ANGELO	294.850
1826		THE NORTHERN TRUST COMPANY SUB-ADVISED COLLECTIVE FUNDS TRUST	CARDARELLI ANGELO	359.081
1119		THE PRUDENTIAL INSURANCE COMPANY OF AMERICA	CARDARELLI ANGELO	101.558
1120		THE PRUDENTIAL INSURANCE COMPANY OF AMERICA	CARDARELLI ANGELO	110.671
1325		THE PRUDENTIAL INSURANCE COMPANY OF AMERICA	CARDARELLI ANGELO	39.000
242		THE PRUDENTIAL INVESTMENT PORTFOLIOS INCDRYDEN ACTIVE ALLOCATION	CARDARELLI ANGELO	4.558
1018		THE REGENTS OF THE UNIVERSITY OF CALIFORNIA	CARDARELLI ANGELO	254.787
1019		THE REGENTS OF THE UNIVERSITY OF CALIFORNIA	CARDARELLI ANGELO	1.671.272
1020		THE REGENTS OF THE UNIVERSITY OF CALIFORNIA	CARDARELLI ANGELO	88.097
1021		THE REGENTS OF THE UNIVERSITY OF CALIFORNIA	CARDARELLI ANGELO	99.226
1524		THE REGENTS OF THE UNIVERSITY OF CALIFORNIA	CARDARELLI ANGELO	408.964
1983		THE REPRESENTATIVE CHURCH BODY	CARDARELLI ANGELO	73.522
1474		THE RETIREMENT ANN PL FOR EMPL OF THE ARMY&AIR FORCE EX SERV	CARDARELLI ANGELO	126.480
423		THE ROYAL BANK OF SCOTLAND GROUP PENSION FUND	CARDARELLI ANGELO	1.198.291
424		THE ROYAL BANK OF SCOTLAND GROUP PENSION FUND	CARDARELLI ANGELO	684.450
295		THE ROYAL BANK OF SCOTLAND PLC AS TRUSTEE OF BLACKROCK WORLDRESOURCES INCOME FU	CARDARELLI ANGELO	41.169
1688		THE ROYAL BOROUGH OF GREENWICH PENSION FUND	CARDARELLI ANGELO	24.259

ASSEMBLEA ORDINARIA 12 MAGGIO 2016

Segreteria Societaria - Ufficio Titoli

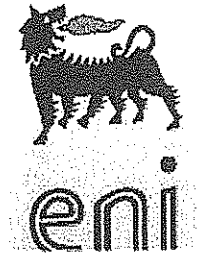

Unica convocazione

Esito della votazione sul punto 2

Attribuzione dell'utile di esercizio

81607/1149

L. M. M.

Elenco Favorevoli

SCHEDA VPC	NOMINATIVO AZIONISTA	DELEGATO	NUMERO DI AZIONI TOTALE
2978	THE ROYAL BOROUGH OF WINDSOR AND MAIDENHEAD AS THEADMINISTERING AUTHORITY OF THE	CARDARELLI ANGELO	336.449
542	THE ROYAL INST FOR THE ADVANCEMENT OF LEARNING MCGILL UNIVERSITY	CARDARELLI ANGELO	9.639
519	THE STATE OF CONNECTICUT ACTINGTHROUGH ITS TREASURER	CARDARELLI ANGELO	234.077
520	THE STATE OF CONNECTICUT ACTINGTHROUGH ITS TREASURER	CARDARELLI ANGELO	422.774
521	THE STATE OF CONNECTICUT ACTINGTHROUGH ITS TREASURER	CARDARELLI ANGELO	332.249
522	THE STATE OF CONNECTICUT ACTINGTHROUGH ITS TREASURER	CARDARELLI ANGELO	38.379
2014	THE TM OVERSTONE UCITS EQUITY INCOME FUND	CARDARELLI ANGELO	108.772
1646	THE TRUSTEES OF AIRWAYS PENSION SCHEME	CARDARELLI ANGELO	103.155
1684	THE TRUSTEES OF AMEC STAFF PENSION SCHEME	CARDARELLI ANGELO	176.356
1662	THE TRUSTEES OF BP PENSION FUND	CARDARELLI ANGELO	645.070
2019	THE TRUSTEES OF CABLE & WIRELESS SUPERANNUATION FUND	CARDARELLI ANGELO	75.850
1677	THE TRUSTEES OF CONOCOPHILLIPS PENSION PLAN	CARDARELLI ANGELO	76.829
1647	THE TRUSTEES OF NEW AIRWAYS PENSION SCHEME	CARDARELLI ANGELO	16.785
1648	THE TRUSTEES OF NEW AIRWAYS PENSION SCHEME	CARDARELLI ANGELO	895.925
1718	THE TRUSTEES OF SAL PENSION SCHEME	CARDARELLI ANGELO	16.410
1675	THE TRUSTEES OF STAGECOACH GROUP PENSION SCHEME	CARDARELLI ANGELO	278.000
2018	THE TRUSTEES OF THE BT PENSION SCHEME	CARDARELLI ANGELO	152.310
1713	THE TRUSTEES OF THE CARNEGIE TRUST FOR UNI OF SCOTLAND	CARDARELLI ANGELO	127.430
2028	THE TRUSTEES OF THE CIVIL AVIATION AUTHORITY PENSION SCHEME	CARDARELLI ANGELO	161.224
1928	THE TRUSTEES OF THE HENRY SMITH CHARITY	CARDARELLI ANGELO	90.779
1715	THE TRUSTEES OF THE PHILLIPS 66 UK PENSION PLAN	CARDARELLI ANGELO	17.744
2030	THE TRUSTESS OF IBM PENSION PLAN	CARDARELLI ANGELO	98.527
1562	THE UNIVERSAL INST F INC - GLOBAL STRATEGIST PORTFOLIO	CARDARELLI ANGELO	2.182

ms

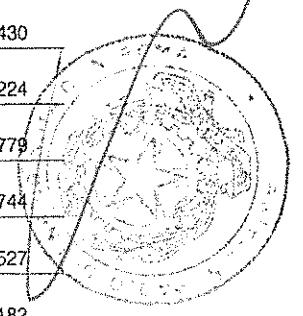

ASSEMBLEA ORDINARIA

81607/1150 12 MAGGIO 2016

Segreteria Societaria - Ufficio Titoli



eni

Unica convocazione

Esito della votazione sul punto 2

Attribuzione dell'utile di esercizio

Elenco Favorevoli

SCHEDA	VPC	NOMINATIVO AZIONISTA	DELEGATO	NUMERO DI AZIONI TOTALE
985		THE WALT DISNEY COMPANY RETIREMENT PLAN MASTER TRUST	CARDARELLI ANGELO	10.864
986		THE WALT DISNEY COMPANY RETIREMENT PLAN MASTER TRUST	CARDARELLI ANGELO	10.855
1289		THE WELLINGTON TR CO NAT ASS MULT COLLECTIVE INV F TRUST II	CARDARELLI ANGELO	2.800
1291		THE WELLINGTON TR CO NAT ASS MULT COLLECTIVE INV F TRUST II	CARDARELLI ANGELO	138.558
1292		THE WELLINGTON TR CO NAT ASS MULT COLLECTIVE INV F TRUST II	CARDARELLI ANGELO	54.710
1591		THE WELLINGTON TR CO NAT ASS MULT COLLECTIVE INV F TRUST II	CARDARELLI ANGELO	237.992
1574		THE WELLINGTON TR CO NAT ASS MULT COM ALPHA STRATEGIES PTF	CARDARELLI ANGELO	118.087
1593		THE WELLINGTON TR CO NAT ASS MULT COMM TR F TR GLB RES EQ PTF	CARDARELLI ANGELO	10.624
1592		THE WELLINGTON TR CO, NAT ASS MULT COMM TR F TR, INT RES EQ F	CARDARELLI ANGELO	36.696
1286		THE WELLINGTON TR COM NATIONAL ASS MULT COLLECT INV F TRUST	CARDARELLI ANGELO	17.758
1287		THE WELLINGTON TR COM NATIONAL ASS MULT COLLECT INV F TRUST	CARDARELLI ANGELO	8.807
1288		THE WELLINGTON TR COM NATIONAL ASS MULT COLLECT INV F TRUST	CARDARELLI ANGELO	4.385
1589		THE WELLINGTON TR COM NATIONAL ASS MULT COLLECT INV F TRUST	CARDARELLI ANGELO	145.803
1590		THE WELLINGTON TR COM NATIONAL ASS MULT COLLECT INV F TRUST	CARDARELLI ANGELO	21.362
58		THREADNEEDLE (LUX	CARDARELLI ANGELO	17.457
1441		THRIFT SAVINGS PLAN	CARDARELLI ANGELO	6.924.427
1818		THYSSEN GLOBAL INVESTMENTS CORP	CARDARELLI ANGELO	12.035
989		TIAA-CREF FUNDS - ENHANCED INTERNATIONAL EQUITY INDEX FUND	CARDARELLI ANGELO	219.008
990		TIAA-CREF FUNDS - TIAA-CREF GLOBAL NATURAL RESOURCES FUND	CARDARELLI ANGELO	149.512
1070		TIFF INVESTMENT PROGRAM, INC - TIFF MULTI-ASSET FUND	CARDARELLI ANGELO	217.808
1512		TIAA-CREF INTERNATIONAL EQUITY INDEX FUND	CARDARELLI ANGELO	1.416.628
732		TIME WARNER CABLE PENSION PLANS MASTER TRUST	CARDARELLI ANGELO	97.603
2588		TNCO FONDS	CARDARELLI ANGELO	20.000

ASSEMBLEA ORDINARIA 12 MAGGIO 2016

Segreteria Societaria - Ufficio Titoli



eni

Unica convocazione

Esito della votazione sul punto 2

Attribuzione dell'utile di esercizio

81607/151

Nanni

Elenco Favorevoli

SCHEDA	VP	NOMINATIVO AZIONISTA	DELEGATO	NUMERO DI AZIONI TOTALE
1881		TORONTO TRANSIT COMMISSON PENSION FUND SOCIETY	CARDARELLI ANGELO	82.500
2244		TOUCHSTONE INTERNATIONAL	CARDARELLI ANGELO	56.291
975		TOYOTA MOTOR PENSION FUND	CARDARELLI ANGELO	29.211
1071		TRANSAMERICA AB DYNAMIC ALLOCATION VP	CARDARELLI ANGELO	10.808
1068		TRANSAMERICA INTERNATIONAL EQUITY	CARDARELLI ANGELO	1.864.900
1538		TRANSAMERICA INTERNATIONAL EQUITY OPPORTUNITIES	CARDARELLI ANGELO	323.228
1069		TRANSAMERICA JPMORGAN TACTICAL ALLOCATION VP	CARDARELLI ANGELO	1.256
34		TRANSAMERICA LIFE INSURANCE COMPANY	CARDARELLI ANGELO	56.527
1542		TRANSAMERICA MFS INTERNATIONAL EQUITY VP	CARDARELLI ANGELO	141.992
1540		TRANSAMERICA TS+W INTERNATIONAL EQUITY VP	CARDARELLI ANGELO	82.496
614		TREASURER OF THE STATE OF NORTH CAROLINA EQUITY INVESTMENT FUND POOLED	CARDARELLI ANGELO	883.934
615		TREASURER OF THE STATE OF NORTH CAROLINA EQUITY INVESTMENT FUND POOLED	CARDARELLI ANGELO	740.404
616		TREASURER OF THE STATE OF NORTH CAROLINA EQUITY INVESTMENT FUND POOLED	CARDARELLI ANGELO	34.928
617		TREASURER OF THE STATE OF NORTH CAROLINA EQUITY INVESTMENT FUND POOLED	CARDARELLI ANGELO	1.020.600
618		TREASURER OF THE STATE OF NORTH CAROLINA EQUITY INVESTMENT FUND POOLED	CARDARELLI ANGELO	2.208.988
619		TREASURER OF THE STATE OF NORTH CAROLINA EQUITY INVESTMENT FUND POOLED	CARDARELLI ANGELO	700.827
1929		TRINITY COLLEGE CAMBRIDGE	CARDARELLI ANGELO	18.034
2238		TRUST & CUSTODY SERV	CARDARELLI ANGELO	165.900
3263		TRUST & CUSTODY SERVICES BANK LTD AS TRUSTEE FOR PENSION INVESTMENT FUND TRUST NUM	CARDARELLI ANGELO	90.845
2236		TRUST AND CUSTODY SERV	CARDARELLI ANGELO	1.526
3046		TRUST AND CUSTODY SERVICED BANK LIMITED	CARDARELLI ANGELO	44.644
3047		TRUST AND CUSTODY SERVICED BANK LIMITED	CARDARELLI ANGELO	119.150
3089		TRUST AND CUSTODY SERVICED BANK LIMITED	CARDARELLI ANGELO	102.278

Sma

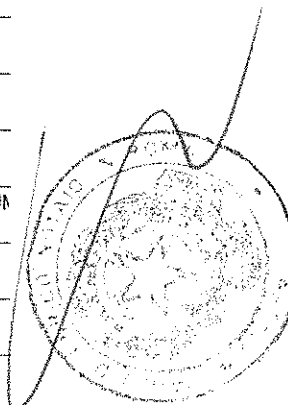

ASSEMBLEA ORDINARIA

81607/4152 12 MAGGIO 2016

Segreteria Societaria - Ufficio Titoli



eni

Unica convocazione

Esito della votazione sul punto 2

Attribuzione dell'utile di esercizio

Elenco Favorevoli

SCHEDA	VPC	NOMINATIVO AZIONISTA	DELEGATO	NUMERO DI AZIONI TOTALE
3090		TRUST AND CUSTODY SERVICED BANK LIMITED	CARDARELLI ANGELO	193.698
3091		TRUST AND CUSTODY SERVICED BANK LIMITED	CARDARELLI ANGELO	21.720
3259		TRUST E CUSTODY SERVICES BANK LTD	CARDARELLI ANGELO	156.251
3260		TRUST E CUSTODY SERVICES BANK LTD	CARDARELLI ANGELO	44.825
3261		TRUST E CUSTODY SERVICES BANK LTD	CARDARELLI ANGELO	14.943
3262		TRUST E CUSTODY SERVICES BANK LTD	CARDARELLI ANGELO	208.473
1473		TRUST FOR RETIR MED, DENT & LIFE INS ARMY&AIR FORCE EXCH	CARDARELLI ANGELO	77.682
1664		TRUSTEES OF KINGFISHER PENSION SCHEME	CARDARELLI ANGELO	23.265
1716		TRUSTEES OF ROYAL INSURANCE GROUP PENSION SCHEME	CARDARELLI ANGELO	29.967
579		TRUSTEES OF THE ESTATE OF BERNICE PAUAHIBISHOP DBA KAMAHAMEHA SCHOOLS	CARDARELLI ANGELO	34.548
572		TS&W COLLECTIVE INVESTMENT TR TS&W INTL LARGE CAP EQUITY TRUST	CARDARELLI ANGELO	209.700
1930		TYCO ELECTRONICS DEFINED BENEFIT PLANS MASTER TRUST	CARDARELLI ANGELO	14.897
607		U.S.AND INTERNATIONAL EQUITY CLASS	CARDARELLI ANGELO	8.257
999		UAW RETIREE MEDICAL BENEFITS TRUST	CARDARELLI ANGELO	16.420
1000		UAW RETIREE MEDICAL BENEFITS TRUST	CARDARELLI ANGELO	8.841
1035		UAW RETIREE MEDICAL BENEFITS TRUST	CARDARELLI ANGELO	45.449
1036		UAW RETIREE MEDICAL BENEFITS TRUST	CARDARELLI ANGELO	25.638
1037		UAW RETIREE MEDICAL BENEFITS TRUST	CARDARELLI ANGELO	13.040
1045		UAW RETIREE MEDICAL BENEFITS TRUST	CARDARELLI ANGELO	29.915
1046		UAW RETIREE MEDICAL BENEFITS TRUST	CARDARELLI ANGELO	17.218
1272		UAW RETIREE MEDICAL BENEFITS TRUST	CARDARELLI ANGELO	125.148
1273		UAW RETIREE MEDICAL BENEFITS TRUST	CARDARELLI ANGELO	120.740
1274		UAW RETIREE MEDICAL BENEFITS TRUST	CARDARELLI ANGELO	119.137

ASSEMBLEA ORDINARIA 12 MAGGIO 2016

Segreteria Societaria - Ufficio Titoli



eni

81607/453

Mura

Unica convocazione

Esito della votazione sul punto 2

Attribuzione dell'utile di esercizio

Elenco Favorevoli

SCHEDA	VPC	NOMINATIVO AZIONISTA	DELEGATO	NUMERO DI AZIONI TOTALE
1275		UAW RETIREE MEDICAL BENEFITS TRUST	CARDARELLI ANGELO	179.331
1276		UAW RETIREE MEDICAL BENEFITS TRUST	CARDARELLI ANGELO	69.267
1277		UAW RETIREE MEDICAL BENEFITS TRUST	CARDARELLI ANGELO	193.892
1268		UBS (IRL) ETF PLC	CARDARELLI ANGELO	3.032
1269		UBS (IRL) ETF PLC	CARDARELLI ANGELO	17.189
1270		UBS (IRL) ETF PLC	CARDARELLI ANGELO	11.944
89		UBS (LUX) EQUITY SICAV	CARDARELLI ANGELO	7.080
94		UBS (LUX) EQUITY SICAV	CARDARELLI ANGELO	396.719
93		UBS (LUX) SICAV 1	CARDARELLI ANGELO	4.911
95		UBS (LUX) STRATEGY XTRA SICAV	CARDARELLI ANGELO	22.702
2899		UBS (US) GROUP TRUST	CARDARELLI ANGELO	85.011
1386		UBS ETF	CARDARELLI ANGELO	336
1387		UBS ETF	CARDARELLI ANGELO	289
1389		UBS ETF	CARDARELLI ANGELO	1.232.417
1390		UBS ETF	CARDARELLI ANGELO	82.242
1391		UBS ETF	CARDARELLI ANGELO	19.723
1392		UBS ETF	CARDARELLI ANGELO	28.649
1393		UBS ETF	CARDARELLI ANGELO	769.374
1394		UBS ETF	CARDARELLI ANGELO	312.329
1388		UBS ETF-UBS-ETF DJ EURO STOXX 50	CARDARELLI ANGELO	610.947
3141		UBS FTSE RAFI DEVELOPED 1000 INDEX FUND	CARDARELLI ANGELO	70.764
87		UBS FUND MANAGEMENT (SWITZERLAND) AG.	CARDARELLI ANGELO	1.596.650
88		UBS FUND MANAGEMENT(LUXEMBOURG) SA	CARDARELLI ANGELO	72.261

mm

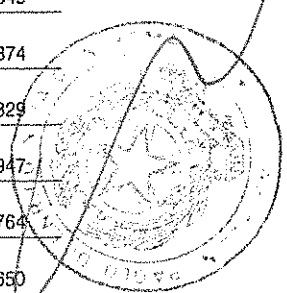

ASSEMBLEA ORDINARIA

81607/150 12 MAGGIO 2016

Segreteria Societaria - Ufficio Titoli



eni

Unica convocazione

Esito della votazione sul punto 2

Attribuzione dell'utile di esercizio

Elenco Favorevoli

SCHEDA	VPC	NOMINATIVO AZIONISTA	DELEGATO	NUMERO DI AZIONI TOTALE
2846		UBS GLOBAL ASSET MANAGEMENT LIFE LTD	CARDARELLI ANGELO	556.303
2915		UBS GLOBAL ASSET MANAGEMENT LIFE LTD	CARDARELLI ANGELO	40.224
2917		UBS GLOBAL ASSET MANAGEMENT LIFE LTD	CARDARELLI ANGELO	149.502
90		UBS GLOBAL SOLUTIONS - GLOBAL EQUITIES EUR	CARDARELLI ANGELO	16.085
91		UBS GLOBAL SOLUTIONS - GLOBAL EQUITIES II EUR	CARDARELLI ANGELO	18.765
1749		UBS IQ MSCI EUROPE ETHICAL ETF	CARDARELLI ANGELO	1.739
1748		UBS IQ MSCI WORLD EX AUSTRALIA ETHICAL ETF	CARDARELLI ANGELO	1.503
2257		UF 6 A ACT	CARDARELLI ANGELO	65.000
580		UFCW CONSOLIDATED PENSION FUND	CARDARELLI ANGELO	795
3242		UKA-FONDS	CARDARELLI ANGELO	49.000
698		UMC BENEFIT BOARD, INC	CARDARELLI ANGELO	53.800
3275		UNION BANCAIRE PRIVEE	CARDARELLI ANGELO	28.335
3274		UNION BANCAIRE PRIVEE EUROPE SA	CARDARELLI ANGELO	1.034.875
2436		UNION GENERALE DE RETRAITE DES CADRES	CARDARELLI ANGELO	1.778
2434		UNION GENERALE DE RETRAITE/REPARTIT.	CARDARELLI ANGELO	26.259
272		UNIPENSION INVEST FMBA EUROPÆISKE AKTIER	CARDARELLI ANGELO	380.668
2637		UNISUPER	CARDARELLI ANGELO	45.641
1838		UNIT NAT RELIEF AND WORKS AG FOR PALEST REF IN THE NEAR EAST	CARDARELLI ANGELO	12.430
1799		UNITED FOOD AND COMM WORK UNION LOCAL 152 RET MEAT PENS PL	CARDARELLI ANGELO	17.488
1835		UNITED NATIONS, ON BEHALF OF UNITED NATIONS UNIVERSITY END F	CARDARELLI ANGELO	36.000
700		UNITED TECHNOLOGIES CORP. MASTER RETIREMENT TR	CARDARELLI ANGELO	46.266
701		UNITED TECHNOLOGIES CORP. MASTER RETIREMENT TR	CARDARELLI ANGELO	77.025
984		UNITED TECHNOLOGIES CORPORATION EMPLOYEE SAVINGS PLAN	CARDARELLI ANGELO	171.442

ASSEMBLEA ORDINARIA 12 MAGGIO 2016

Segreteria Societaria - Ufficio Titoli



eni

81607/1155

m

Unica convocazione

Esito della votazione sul punto 2

Attribuzione dell'utile di esercizio

Elenco Favorevoli

SCHEDA	VPC	NOMINATIVO AZIONISTA	DELEGATO	NUMERO DI AZIONI TOTALE
784		UNIVERS CNP 1	CARDARELLI ANGELO	121.348
1566		UNIVERSAL INVESTMENT FUNDS	CARDARELLI ANGELO	62.600
355		UNIVERSAL SHIPOWNERS MARINE INSURANCE ASSOCIATION LIMITED	CARDARELLI ANGELO	16.894
2742		UNIVERSE THE CMI GLOBAL NETWORK FUND	CARDARELLI ANGELO	475.846
3238		UNIVERSITIES SUPERANNUATION SCHEME	CARDARELLI ANGELO	3.600.000
3239		UNIVERSITIES SUPERANNUATION SCHEME	CARDARELLI ANGELO	496.000
699		UNIVERSITY OF PITTSBURGH MEDICAL CENTER SYSTE	CARDARELLI ANGELO	32.136
2098		UNIVEST	CARDARELLI ANGELO	89.377
639		UPMC BASIC RETIREMENT PLAN MASTER TRUST	CARDARELLI ANGELO	18.435
696		UPS GROUP TRUST	CARDARELLI ANGELO	40.365
697		UPS GROUP TRUST	CARDARELLI ANGELO	16.092
900		US RETIREMENT TRUST	CARDARELLI ANGELO	4.192
926		USAA INTERNATIONAL FUND	CARDARELLI ANGELO	979.258
927		USAA INTERNATIONAL FUND	CARDARELLI ANGELO	491.087
1987		UTAH STATE RETIREMENT SYSTEMS	CARDARELLI ANGELO	370.368
224		VALERO ENERGY CORPORATION PENSION PLAN	CARDARELLI ANGELO	152.918
126		VALIANT AKTIEN EUROP	CARDARELLI ANGELO	45.689
1527		VALIC COMPANY I - FOREIGN VALUE FUND	CARDARELLI ANGELO	524.979
1529		VALIC COMPANY I - GLOBAL STRATEGY FUND	CARDARELLI ANGELO	177.112
1526		VALIC COMPANY I - INTERNATIONAL EQUITIES FUND	CARDARELLI ANGELO	192.018
1528		VALIC COMPANY I-INTERNATIONAL GROWTH I FUND	CARDARELLI ANGELO	57.014
2697		VALOR ACTIONS	CARDARELLI ANGELO	40.000
1854		VALUEQUEST PARTNERS LLC	CARDARELLI ANGELO	16.695

m

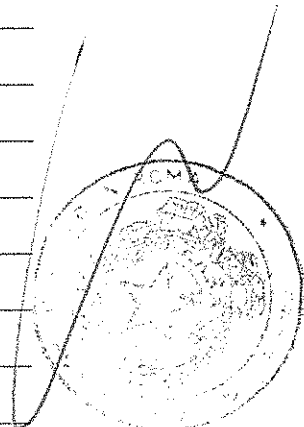

ASSEMBLEA ORDINARIA

81607/1156 12 MAGGIO 2016

Segreteria Societaria - Ufficio Titoli



eni

Unica convocazione

Esito della votazione sul punto 2

Attribuzione dell'utile di esercizio

Elenco Favorevoli

SCHEDA	VPC	NOMINATIVO AZIONISTA	DELEGATO	NUMERO DI AZIONI TOTALE
1988		VAN ANDEL INSTITUTE	CARDARELLI ANGELO	23.938
1280		VANGUARD DEVEL ALL-CAP EX NORTH AMERICA EQT IND POOLED FUND	CARDARELLI ANGELO	4.185
2368		VANGUARD DEVELOPED MARKETS INDEX FUND	CARDARELLI ANGELO	9.420.248
2390		VANGUARD ENERGY FUND	CARDARELLI ANGELO	235.939
2367		VANGUARD EUROPEAN STOCK INDEX FUND	CARDARELLI ANGELO	5.411.220
2983		VANGUARD FID COMPANY EUROPEAN STOCK INDE	CARDARELLI ANGELO	154.009
2389		VANGUARD FTSE ALL-WORLD EX US INDEX FUND	CARDARELLI ANGELO	3.361.138
1279		VANGUARD FTSE DEVELOPED ALL CAP EX NORTH AMERICA INDEX ETF	CARDARELLI ANGELO	7.354
1278		VANGUARD FTSE DEVELOPED EUROPE ALL CAP INDEX ETF	CARDARELLI ANGELO	25.347
1283		VANGUARD FTSE DEVELOPED EUROPE INDEX ETF	CARDARELLI ANGELO	4.360
2398		VANGUARD FUNDS PLC	CARDARELLI ANGELO	65.566
2404		VANGUARD FUNDS PLC	CARDARELLI ANGELO	53.762
2405		VANGUARD FUNDS PLC	CARDARELLI ANGELO	167.666
2414		VANGUARD FUNDS PLC	CARDARELLI ANGELO	106.995
2415		VANGUARD FUNDS PLC	CARDARELLI ANGELO	4.389
411		VANGUARD INTERNATIONAL HIGH DIVIDEND YIELD INDEX FUND	CARDARELLI ANGELO	10.216
2889		VANGUARD INTERNATIONAL SHARE INDEX FUND	CARDARELLI ANGELO	741.486
1724		VANGUARD INV F ICVC-VANGUARD FTSE DEV EUROPE EX-UK EQ INDEX F	CARDARELLI ANGELO	566.481
1723		VANGUARD INV FDS ICVC-VANG FTSE DEV WOR LD EX - UK EQT IND FD	CARDARELLI ANGELO	238.802
2788		VANGUARD INVESTMENT SERIES, PLC	CARDARELLI ANGELO	2
2789		VANGUARD INVESTMENT SERIES, PLC	CARDARELLI ANGELO	122.652
2790		VANGUARD INVESTMENT SERIES, PLC	CARDARELLI ANGELO	108.549
2791		VANGUARD INVESTMENT SERIES, PLC	CARDARELLI ANGELO	17.806

ASSEMBLEA ORDINARIA 12 MAGGIO 2016

Segreteria Societaria - Ufficio Titoli



81607/1157

1
2
3
4
5
6
7
8
9
10
11
12

Unica convocazione

Esito della votazione sul punto 2

Attribuzione dell'utile di esercizio

Elenco Favorevoli

SCHEDA	VPC	NOMINATIVO AZIONISTA	DELEGATO	NUMERO DI AZIONI TOTALE
1282		VANGUARD INVESTMENTS COMMON CONTRACTUAL FUND	CARDARELLI ANGELO	68.917
1284		VANGUARD INVESTMENTS COMMON CONTRACTUAL FUND	CARDARELLI ANGELO	49.038
1285		VANGUARD INVESTMENTS COMMON CONTRACTUAL FUND	CARDARELLI ANGELO	17.781
1281		VANGUARD INVESTMENTS II COMMON CONTRACTUAL FUND	CARDARELLI ANGELO	49.878
2980		VANGUARD TOTAL INTERNATIONAL STOCK INDEX	CARDARELLI ANGELO	25.807.600
2387		VANGUARD TOTAL WORLD STOCK INDEX FUND	CARDARELLI ANGELO	499.743
2954		VANTAGEPOINT INTERNATIONAL FUND	CARDARELLI ANGELO	914.195
2929		VANTAGEPOINT OVERSEAS EQUITY INDEX FUND	CARDARELLI ANGELO	84.408
3037		VAR INSURANCE PRODUCTS FUND OVERSEAS POR	CARDARELLI ANGELO	169.000
3116		VARIABLE PORTFOLIO-DFA INTER.VALUE FUND	CARDARELLI ANGELO	826.848
724		VEBA PARTNERSHIP N LP .	CARDARELLI ANGELO	54.419
2084		VERDIPAPIRFONDET KLP AKSJEEUROPA INDEKS 1	CARDARELLI ANGELO	197.620
2083		VERDIPAPIRFONDET KLP AKSJGLOBAL INDEX 1	CARDARELLI ANGELO	308.362
3122		VERMONT PENSION INVESTMENT COMMITTE	CARDARELLI ANGELO	230.256
225		VICTORIAN SUPERANNUATION FUND	CARDARELLI ANGELO	139.207
231		VICTORIAN SUPERANNUATION FUND	CARDARELLI ANGELO	46.071
75		VICTORY CAPITAL INTERNATIONAL COLLECTIVE INVESTMENT TRUST	CARDARELLI ANGELO	7.818
104		VICTORY GLOBAL EQUITY FUND	CARDARELLI ANGELO	10.001
810		VILLIERS ALTO	CARDARELLI ANGELO	35.033
703		VIRGINIA RETIREMENT SYSTEM .	CARDARELLI ANGELO	26.566
704		VIRGINIA RETIREMENT SYSTEM .	CARDARELLI ANGELO	260.836
705		VIRGINIA RETIREMENT SYSTEM .	CARDARELLI ANGELO	356.793
761		VOCATION MARCHE ARIANESPACE CONSEIL DE SURVEILLANCE DU FCP	CARDARELLI ANGELO	2.625

jme

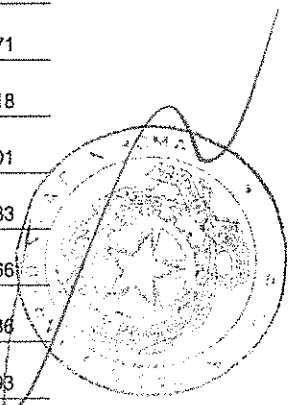

ASSEMBLEA ORDINARIA

81607/US8 12 MAGGIO 2016

Segreteria Societaria - Ufficio Titoli



eni

Unica convocazione

Esito della votazione sul punto 2

Attribuzione dell'utile di esercizio

Elenco Favorevoli

SCHEDA	VPC	NOMINATIVO AZIONISTA	DELEGATO	NUMERO DI AZIONI TOTALE
1774		VOL EMPL BEN ASS OF THE NON-REPR EMPL OF SOUT CAL EDISON CO	CARDARELLI ANGELO	4.325
271		VOYA EURO STOXX 50INDEX PORTFOLIO	CARDARELLI ANGELO	567.637
238		VOYA GLOBAL EQUITY DIVIDEND ANDPREMIUM OPPORTUNITY FUND	CARDARELLI ANGELO	532.987
243		VOYA INTERNATIONAL HIGH DIVIDEND EQUITY INCOME FUND	CARDARELLI ANGELO	9.922
264		VOYA INTERNATIONAL INDEX PORTFOLIO	CARDARELLI ANGELO	267.724
256		VY TEMPLETON FOREIGN EQUITY PORTFOLIO	CARDARELLI ANGELO	680.187
221		VY TEMPLETON GLOBAL GROWTH PORTFOLIO	CARDARELLI ANGELO	115.691
3183		Veritas Global Equity Income Fund	CARDARELLI ANGELO	4.220.000
1304		WASHINGTON STATE INVESTMENT BOARD	CARDARELLI ANGELO	1.004.969
1305		WASHINGTON STATE INVESTMENT BOARD	CARDARELLI ANGELO	2.244.064
1306		WASHINGTON STATE INVESTMENT BOARD	CARDARELLI ANGELO	72.313
2417		WELL TC NAM CONTRARIAN VALUE PORTFOLIO	CARDARELLI ANGELO	113.448
2408		WELLING TRUST COMP NAT ASSOC MULTIP COMM	CARDARELLI ANGELO	1.541.734
76		WELLINGTON GL RES EQ PTFO ATTN SIJIA CHEN MACQUARIE INVESTMENT MANAGEMENT LIMITED	CARDARELLI ANGELO	7.177
2383		WELLINGTON MANAGEMENT PORTFOLIOS (LUX) IV SICAV-FIS-GL MULT-AS TARRET PF	CARDARELLI ANGELO	6.649
2380		WELLINGTON MANAGNT PORTFOLIOS GLOB RESEA	CARDARELLI ANGELO	61.226
1573		WELLINGTON MGMT PTF KY-DIVERSIFIED INFLATION HEDGES PTF-Q INV	CARDARELLI ANGELO	158.546
1290		WELLINGTON TR CO, NAT ASS M. COMM.TR.FDS TR GL. NAT RES. PTF	CARDARELLI ANGELO	533.931
2396		WELLINGTON TRUST COMP COMM TRUST INT OPP	CARDARELLI ANGELO	152.532
564		WELLMARK INC. .	CARDARELLI ANGELO	45.238
565		WELLMARK OF SOUTH DAKOTA INC .	CARDARELLI ANGELO	20.920
1298		WELLS FARGO ADVANTAGE INFLATION-PROTECTED BOND PORTFOLIO	CARDARELLI ANGELO	32.056
1300		WELLS FARGO ALTERNATIVE STRATEGIES FUND	CARDARELLI ANGELO	7.302

ASSEMBLEA ORDINARIA

12 MAGGIO 2016

Segreteria Societaria - Ufficio Titoli



eni

81607/1159

Handwritten signature

Handwritten signature

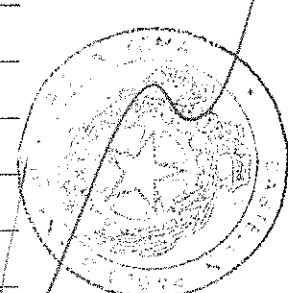

Unica convocazione

Esito della votazione sul punto 2

Attribuzione dell'utile di esercizio

Elenco Favorevoli

SCHEDA	VPC	NOMINATIVO AZIONISTA	DELEGATO	NUMERO DI AZIONI TOTALE
278		WELLS FARGO AND CO CASH BALANCEPLAN	CARDARELLI ANGELO	345.219
279		WELLS FARGO AND CO CASH BALANCEPLAN	CARDARELLI ANGELO	32.497
1293		WELLS FARGO BK DECL OF TR EST INV FUNDS FOR EMPLOYEE BEN TR	CARDARELLI ANGELO	61.601
1295		WELLS FARGO DIVERSIFIED INTERNATIONAL FUND	CARDARELLI ANGELO	59.912
887		WELLS FARGO GLOBAL DIVIDEND OPPORTUNITY FUND	CARDARELLI ANGELO	50.000
1299		WELLS FARGO GLOBAL LONG/SHORT FUND	CARDARELLI ANGELO	10.356
1296		WELLS FARGO INTERNATIONAL EQUITY FUND	CARDARELLI ANGELO	706.721
1294		WELLS FARGO VT INTERNATIONAL EQUITY FUND	CARDARELLI ANGELO	520.255
1297		WELLS FARGOMASTER TRUST DIVERSIFIED STOCK PORTFOLIO	CARDARELLI ANGELO	247.150
3184		WEST MIDLANDS METROPOLITAN AUT PENS FD	CARDARELLI ANGELO	550.586
3185		WEST YORKSHIRE PENSION FUND	CARDARELLI ANGELO	500.000
1482		WESTERN METAL INDUSTRY PENSION	CARDARELLI ANGELO	60.342
3142		WESTMINSTER ARTEMIS GLOBAL ENERGY FUND	CARDARELLI ANGELO	106.581
1738		WESTPAC INTERNATIONAL SHARE INDEX TRUST	CARDARELLI ANGELO	123.345
823		WHEATON COLLEGE TRUST COMPANY, N.A AS TRUSTEE OF THE WHEATON	CARDARELLI ANGELO	45.425
2024		WHEELS COMMON INVESTMENT FUND	CARDARELLI ANGELO	73.789
2025		WHEELS COMMON INVESTMENT FUND	CARDARELLI ANGELO	54.970
2624		WHOLESALE GLOBAL EQUITY INDEX FUND	CARDARELLI ANGELO	14.843
3219		WHOLESALE UNIT TRUST GLOBAL SHARES F 3	CARDARELLI ANGELO	13.294
2635		WHOLESALE UNIT TRUST MSCI GLOB INDEX SHS	CARDARELLI ANGELO	63.144
867		WILLIAM BEAUMONT HOSPITAL	CARDARELLI ANGELO	7.980
866		WILLIAM BEAUMONT HOSPITAL EMPLOYEES' RETIREMENT PLAN	CARDARELLI ANGELO	14.068
303		WILMINGTON MULTI-MANAGER INTERNATIONAL FUND	CARDARELLI ANGELO	12.627

ASSEMBLEA ORDINARIA81607/1160 **12 MAGGIO 2016**

Segreteria Societaria - Ufficio Titoli

**eni**

Unica convocazione

Esito della votazione sul punto 2

Attribuzione dell'utile di esercizio**Elenco Favorevoli**

SCHEDA	VPC	NOMINATIVO AZIONISTA	DELEGATO	NUMERO DI AZIONI TOTALE
1302		WILMINGTON TRUST RETIREMENT AND INST SER CO COLLECTIVE INV TR	CARDARELLI ANGELO	136.400
361		WILSHIRE INSTITUTIONAL MASTER FUND SPC	CARDARELLI ANGELO	2.300
1819		WINDWISE SEEDING FUND SPC, LTD	CARDARELLI ANGELO	7.117
1777		WISCONSIN PUBLIC SERVICE CORPORATION MASTER WELFARE BENEFIT TR	CARDARELLI ANGELO	31.900
1309		WISDOMTREE DEFA EQUITY INCOME FUND	CARDARELLI ANGELO	242.479
1307		WISDOMTREE DYNAMIC CURRENCY HEDGED EUROPE EQUITY FUND	CARDARELLI ANGELO	9.714
1308		WISDOMTREE DYNAMIC CURRENCY HEDGED INTRNL EQUITY FUND	CARDARELLI ANGELO	122.051
1316		WISDOMTREE EUROPE LOCAL RECOVERY FUND	CARDARELLI ANGELO	2.145
1317		WISDOMTREE GLOBAL EX-U.S. HEDGED DIVIDEND FUND	CARDARELLI ANGELO	1.500
1311		WISDOMTREE GLOBAL HIGH DIVIDEND FUND	CARDARELLI ANGELO	17.623
1312		WISDOMTREE GLOBAL NATURAL RESOURCES FUND	CARDARELLI ANGELO	18.217
1313		WISDOMTREE INTERNATIONAL DIVIDEND EX-FINANCIALS FUND	CARDARELLI ANGELO	306.786
1310		WISDOMTREE INTERNATIONAL EQUITY FUND	CARDARELLI ANGELO	332.123
1315		WISDOMTREE INTERNATIONAL HEDGED EQUITY FUND	CARDARELLI ANGELO	2.378
1314		WISDOMTREE INTERNATIONAL LARGE CAP DIVIDEND FUND	CARDARELLI ANGELO	271.581
1301		WISDOMTREE ISSUER PUBLIC LIMITED COMPANY	CARDARELLI ANGELO	61.526
2505		WITAN INVESTMENT TRUST PLC	CARDARELLI ANGELO	49.200
2506		WITAN INVESTMENT TRUST PLC	CARDARELLI ANGELO	229.000
1880		WM KNIGHT	CARDARELLI ANGELO	7.729
260		WM POOL EQUITIES TRUST NO 20	CARDARELLI ANGELO	267.975
316		WM POOL EQUITIES TRUST NO. 40	CARDARELLI ANGELO	2.206
407		WM POOL-EQUITIES TRUST NO. 75	CARDARELLI ANGELO	73.407
1460		WORLD ALPHA TILTS NON-LENDABLE FUND B	CARDARELLI ANGELO	1.369

ASSEMBLEA ORDINARIA 12 MAGGIO 2016

Segreteria Societaria - Ufficio Titoli

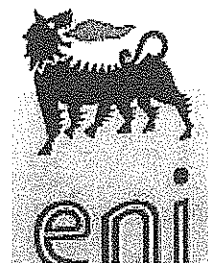

81607/161

V. S. M.

m. s.

Inca convocazione

esito della votazione sul punto 2

Attribuzione dell'utile di esercizio

Elenco Favorevoli

SCHEDA VPC	NOMINATIVO AZIONISTA	DELEGATO	NUMERO DI AZIONI TOTALE
1605	WORLD INDEX OLUS SECURITIES LENDING COMMON TRUST FUND	CARDARELLI ANGELO	35.164
2351	WORLDVIEW INVESTMENT FUND EUROPE CORE EQUITY FUND	CARDARELLI ANGELO	63.600
2870	WSSP INTERNATIONAL EQUITIES TRUST	CARDARELLI ANGELO	30.986
1829	WYOMING RETIREMENT SYSTEM	CARDARELLI ANGELO	48.336
1830	WYOMING RETIREMENT SYSTEM	CARDARELLI ANGELO	35.320
1831	WYOMING RETIREMENT SYSTEM	CARDARELLI ANGELO	14.831
1832	WYOMING RETIREMENT SYSTEM	CARDARELLI ANGELO	43.713
2619	henderson gartmore fund	CARDARELLI ANGELO	2.252.304
3300	MINISTERO DELL'ECONOMIA E DELLE FINANZE DI STEFANO STEFANO		157.552.137
2305	BANK OF NEW YORK MELLON ADR D.	CARDARELLI ANGELO	43.616.264

Riepilogo favorevoli

TOTALE FAVOREVOLI	n°	3.137 azionisti per n°	2.141.183.951 Azioni	99,90467 % delle azioni presenti
di cui				
IN PROPRIO	n°	24 azionisti per n°	174.133 Azioni	0,00812 % delle azioni presenti
PER DELEGA	n°	3.113 azionisti per n°	2.141.009.818 Azioni	99,89654 % delle azioni presenti



ASSEMBLEA ORDINARIA

81607/1162 12 MAGGIO 2016

Segreteria Societaria - Ufficio Titoli

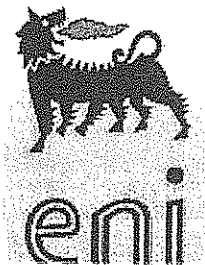

Unica convocazione

Esito della votazione sul punto 2

Attribuzione dell'utile di esercizio

Elenco Contrari

SCHEDA	NOMINATIVO AZIONISTA	DELEGATO	NUMERO DI AZIONI TOTALE
2104	MARINO TOMMASO		1
3208	CPR AM	CARDARELLI ANGELO	374.770
2504	FCP ERAFP ACT EUR5 RO	CARDARELLI ANGELO	720.000
201	FCP OFI OPTIMA EURO	CARDARELLI ANGELO	36.500
2455	FCP REGARD SEL.ACT EURO.	CARDARELLI ANGELO	210.000
2266	MATMUT ACTIONS EURO	CARDARELLI ANGELO	23.000
2265	MIF WORLD EQUITY	CARDARELLI ANGELO	154.755
3258	NIGOSC ADMINISTRERS NILG PENSION FUND	CARDARELLI ANGELO	133.048
2456	REGARD ACTIONS DEVELOPPEMENT DURABLE	CARDARELLI ANGELO	200.000
2305	BANK OF NEW YORK MELLON ADR D.	CARDARELLI ANGELO	70.770

Riepilogo Contrari

TOTALE CONTRARI	n°	10 azionisti per n°	1.922.844 Azioni
di cui			0,08972 % delle azioni presenti
IN PROPRIO	n°	1 azionisti per n°	1 Azioni
			0,00000 % delle azioni presenti
PER DELEGA	n°	9 azionisti per n°	1.922.843 Azioni
			0,08972 % delle azioni presenti

ASSEMBLEA ORDINARIA

12 MAGGIO 2016

Segreteria Societaria - Ufficio Titoli

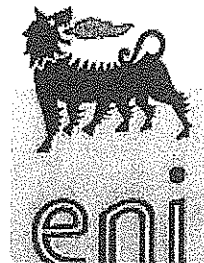

Unica convocazione

Esito della votazione sul punto 2

Attribuzione dell'utile di esercizio

81607/1163

Handwritten signature

Elenco Astenuti

SCHEDA	NOMINATIVO AZIONISTA	DELEGATO	NUMERO DI AZIONI TOTALE
2340	FONDAZIONE CULTURALE RESPONSABILITA' ETICA	MEGGIOLARO MAURO	80
2305	BANK OF NEW YORK MELLON ADR D.	CARDARELLI ANGELO	118.214

Riepilogo Astenuti

TOTALE ASTENUTI	n°	2 azionisti per n°	118.294 Azioni
di cui			0,00552 % delle azioni presenti
IN PROPRIO	n°	0 azionisti per n°	0 Azioni
			0,00000 % delle azioni presenti
PER DELEGA	n°	2 azionisti per n°	118.294 Azioni
			0,00552 % delle azioni presenti

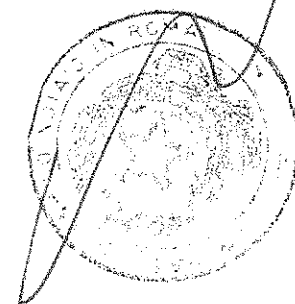

ASSEMBLEA ORDINARIA

81607/4164 12 MAGGIO 2016

Segreteria Societaria - Ufficio Titoli

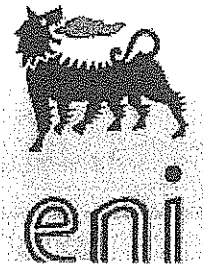

Unica convocazione

Esito della votazione sul punto 2

Attribuzione dell'utile di esercizio

Elenco Non Votanti

SCHEDA	NOMINATIVO AZIONISTA	DELEGATO	NUMERO DI AZIONI TOTALE
2226	NOTARFONZO ARNALDO		2.100

Riepilogo Non votanti

TOTALE NON VOTANTI	n°	1 azionisti per n°	2.100 Azioni 0,00010 % delle azioni presenti
di cui			
IN PROPRIO	n°	1 azionisti per n°	2.100 Azioni 0,00010 % delle azioni presenti
PER DELEGA	n°	0 azionisti per n°	0 Azioni 0,00000 % delle azioni presenti

Notary
Arnaldo

ASSEMBLEA ORDINARIA

12 MAGGIO 2016

Segreteria Societaria - Ufficio Titoli



Unica convocazione

Esito della votazione sul punto 3

ALLEGATO " L "
 ROGITO 22006

Nomina di un Amministratore ai sensi dell'articolo 2386 del Codice Civile

81607/1165

Azionisti Presenti

In proprio	n°	26	per n°	176.234 Azioni	0,00 % del capitale sociale
Per delega	n°	3.122	per n°	2.143.050.955 Azioni	58,97 % del capitale sociale
TOTALE PRESENTI	n°	3.148	per n°	2.143.227.189 Azioni	58,97 % del capitale sociale

Quorum per approvazione

n° 1.071.613.595 Voti favorevoli
(Pari a 1/2 delle Azioni Presenti + 1)

Esito Votazione

FAVOREVOLI	n°	3.029	azionisti per n°	2.121.920.653 Azioni	99,00587 % delle azioni presenti
CONTRARI	n°	101	azionisti per n°	14.409.920 Azioni	0,67235 % delle azioni presenti
ASTENUTI E NON VOTANTI	n°	20	azionisti per n°	6.896.616 Azioni	0,32179 % delle azioni presenti

La Proposta è approvata

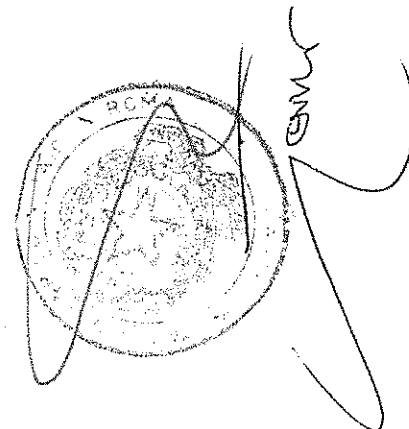

Nota: voti disgiunti addizionali n°

2

12/05/2016

PAGINA ANNULLATA

ASSEMBLEA ORDINARIA 12 MAGGIO 2016

Segreteria Societaria - Ufficio Titoli



Unica convocazione

Esito della votazione sul punto 3

Nomina di un Amministratore ai sensi dell'articolo 2386 del Codice Civile

81607/1166

Elenco Favorevoli

SCHEDA	VPC	NOMINATIVO AZIONISTA	DELEGATO	NUMERO DI AZIONI TOTALE
2102		BELLINO ROCI PIERCARLO		10.000
2218		CAPUTO RITA		250
7		CHIURAZZI LUIGI		3.000
3304		DI TEODORO VITO		100
2224		IADICICCO ANTONIO		2.000
2222		NACCI VITO ROCCO		1
2226		NOTARFONZO ARNALDO		2.100
2106		PAVESI ALBERTO		1
2227		PONTI GIOVANNI		5.065
2330		SCORSONE MIRKO		10
2346		VAVALLI VITO UMBERTO		3.800
2219		ZACCAGNINO RAFFAELE		500
2342		HC RENTE SIEMENS FONDS INVEST GMBH MEGGIOLARO MAURO		25.461
2341		SIEMENS BSAV BALANCED SIEMENS FONDS INVEST GMBH MEGGIOLARO MAURO		27.794
2343		SIEMENS-FONDS SIEMENS-RENTE SIEMENS FONDS INVEST GMBH MEGGIOLARO MAURO		540.828
2344		SIEMENS-FONDS SPT MM SIEMENS FONDS INVEST GMBH MEGGIOLARO MAURO		138.205
3293		CASSA DEPOSITI E PRESTITI SPA	RAMUNDO FABRIZIO	936.179.478
115		ROSSI PAOLO	ROSSI AGOSTINO	4.830
116		ROSSETTI RAUL FERNANDO	TREVISAN DARIO	800
825		ALLEANZA ASSICURAZIONI SPA	CARDINALI LUIGI	715.000
826		ALLEANZA ASSICURAZIONI SPA	CARDINALI LUIGI	861.700
827		ALLEANZA ASSICURAZIONI SPA	CARDINALI LUIGI	424.290

5000

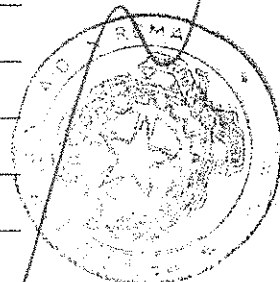

ASSEMBLEA ORDINARIA

81607/1167 12 MAGGIO 2016

Segreteria Societaria - Ufficio Titoli



eni

Unica convocazione

Esito della votazione sul punto 3

Nomina di un Amministratore ai sensi dell'articolo 2386 del Codice Civile

Elenco Favorevoli

SCHEDA VPC	NOMINATIVO AZIONISTA	DELEGATO	NUMERO DI AZIONI TOTALE
828	ALLEANZA ASSICURAZIONI SPA	CARDINALI LUIGI	35.000
829	ALLEANZA ASSICURAZIONI SPA	CARDINALI LUIGI	69.219
830	ALLEANZA ASSICURAZIONI SPA	CARDINALI LUIGI	36.900
831	ALLEANZA ASSICURAZIONI SPA	CARDINALI LUIGI	4.250
3288	GENERTELLIFE SPA	CARDINALI LUIGI	1.469.614
3287	Generali Italia SpA	CARDINALI LUIGI	2.241.867
854	STAMATI ANTONIETTA	SPINA ROSARIO	1.350
2638	1262 FCP BEHR FRANCE	CARDARELLI ANGELO	136
3132	1290 FUNDS - 1290 GLOBAL EQUITY MANAGERS FUND	CARDARELLI ANGELO	6.531
2639	1327 FCP BQUE SCALBERT DUPONT	CARDARELLI ANGELO	6.000
2676	1448 FCPE GE FACTOFRANCE	CARDARELLI ANGELO	3.000
2684	1495 FCP CONTINENTAL	CARDARELLI ANGELO	850
2743	1741 ASSET MANAGEMENT FUNDS SICAV	CARDARELLI ANGELO	44.700
1927	1999 VOL EMPL BEN ASS NON-REPR EMPL OF SOUT CAL EDISON CO	CARDARELLI ANGELO	7.924
2075	7IM AAP ADVENTUROUS FUND	CARDARELLI ANGELO	21.346
2072	7IM AAP BALANCED FUND	CARDARELLI ANGELO	109.692
2071	7IM AAP INCOME FUND	CARDARELLI ANGELO	2.329
2073	7IM AAP MODERATELY ADVENTUROUS FUND	CARDARELLI ANGELO	70.828
2079	7IM AAP MODERATELY CAUTIOUS FUND	CARDARELLI ANGELO	32.440
2076	7IM ADVENTUROUS FUND	CARDARELLI ANGELO	8.325
2074	7IM BALANCED FUND	CARDARELLI ANGELO	26.386
2080	7IM EUROPEAN (EX UK) EQUITY VALUE FUND	CARDARELLI ANGELO	125.101
2077	7IM MODERATELY ADVENTUROUS FUND	CARDARELLI ANGELO	21.124

ASSEMBLEA ORDINARIA 12 MAGGIO 2016

Segreteria Societaria - Ufficio Titoli



Unica convocazione

Esito della votazione sul punto 3

Nomina di un Amministratore ai sensi dell'articolo 2386 del Codice Civile

8160/1168

Handwritten signature

Elenco Favorevoli

SCHEDA	VPC	NOMINATIVO AZIONISTA	DELEGATO	NUMERO DI AZIONI TOTALE
2078		7IM MODERATELY CAUTIOUS FUND	CARDARELLI ANGELO	7.122
208		A.A.-DEXIA ISR	CARDARELLI ANGELO	50.641
1957		A.I.DUPONT TESTAMENTARY TRUST	CARDARELLI ANGELO	63.700
765		AA AMUNDI ISR	CARDARELLI ANGELO	42.191
206		AA FORTIS TACTIQUE	CARDARELLI ANGELO	117.852
1669		ABBEY LIFE ASSURANCE COMPANY LIMITED	CARDARELLI ANGELO	27.123
1670		ABBEY LIFE ASSURANCE COMPANY LIMITED	CARDARELLI ANGELO	212.923
3218		ABERDEEN GLOBAL	CARDARELLI ANGELO	194.800
1708		ABERDEEN INV FUNDS UK ICVC II-ABERDEEN EUR EQ ENHANCED INDEXF	CARDARELLI ANGELO	43.742
3209		ABERDEEN INVESTMENT FUNDS ICVC	CARDARELLI ANGELO	84.900
1013		ABERDEEN NATURAL RESOURCES FUND	CARDARELLI ANGELO	39.600
3277		ABERDEEN SWISS FUNDS GLOBAL ENERGY EQUITY FUND	CARDARELLI ANGELO	13.740
1634		ABN AMRO MULTI-MANAGER FUNDS	CARDARELLI ANGELO	942.992
1635		ABN AMRO MULTI-MANAGER FUNDS	CARDARELLI ANGELO	1.150.625
1636		ABN AMRO MULTI-MANAGER FUNDS	CARDARELLI ANGELO	29.212
2086		ABU DHABI RETIREMENT PENSIONS AND BENEFITS FUND	CARDARELLI ANGELO	202.346
376		ACHMEA PENSIOEN-EN LEVENSVZERZEKERINGEN N.V.	CARDARELLI ANGELO	13.391
374		ACHMEA REINSURANCE COMPANY N.V.	CARDARELLI ANGELO	6.787
370		ACHMEA SCHADEVERZEKERINGEN N.V.	CARDARELLI ANGELO	13.472
2643		ACM ACTIONS	CARDARELLI ANGELO	4.645
2642		ACM ACTIONS PLUS	CARDARELLI ANGELO	8.706
2232		ACMBERNSTEIN SICAV GLOBAL E	CARDARELLI ANGELO	3.665
1755		ACORN 1998 TRUST	CARDARELLI ANGELO	2.631

Handwritten signature

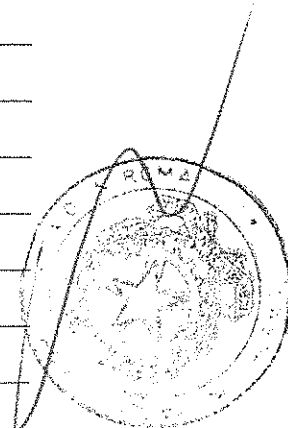

ASSEMBLEA ORDINARIA

81607/469 12 MAGGIO 2016

Segreteria Societaria - Ufficio Titoli



eni

Unica convocazione

Esito della votazione sul punto 3

Nomina di un Amministratore ai sensi dell'articolo 2386 del Codice Civile**Elenco Favorevoli**

SCHEDA	VPC	NOMINATIVO AZIONISTA	DELEGATO	NUMERO DI AZIONI TOTALE
749	ACTIONS EURO CA-MF	CREDIT AGRICOLE ASSET MANAGEMENT	CARDARELLI ANGELO	90.034
145	ACTIONS SELECTION MONDE		CARDARELLI ANGELO	40.000
3112	ACTIVE PORTFOLIOS MULTI MANAGER ALTERNAT		CARDARELLI ANGELO	323.826
1453	ACWI EX-US INDEX MASTER PORTFOLIO OF MASTER INVESTMENT PTF		CARDARELLI ANGELO	119.849
767	ADPACTIONS		CARDARELLI ANGELO	4.278
768	ADPARGNE		CARDARELLI ANGELO	4.927
2702	ADREA DIVERSIFIE FRANCHE COMTE		CARDARELLI ANGELO	2.526
2898	ADVANCE INTERNATIONAL SHARE INDEX FUND		CARDARELLI ANGELO	87.042
346	ADVANCED SERIES TRUST AST FRANKLIN TEMPLETON K2 GLOBAL ABSOLUTE		CARDARELLI ANGELO	5.520
330	ADVANCED SERIES TRUST AST GOLDMAN SACHS MULTI ASSET PORTFOLIO		CARDARELLI ANGELO	66.596
315	ADVANCED SERIES TRUST AST NEW DISCOVERY ASSET ALLOCATION PORTFOL		CARDARELLI ANGELO	67.200
317	ADVANCED SERIES TRUST-AST SCHROEDERS GLOBAL TACTICAL PORTFOLIO		CARDARELLI ANGELO	726.202
2416	ADVISOR MANAGED TRUST - TACTICAL OFFENSI		CARDARELLI ANGELO	23.912
37	AEGON CUSTODY B.V		CARDARELLI ANGELO	275.505
49	AEGON CUSTODY B.V		CARDARELLI ANGELO	85.041
64	AEGON GLOBAL FUNDS		CARDARELLI ANGELO	67.700
483	AGF ALL WORLD TAX ADVANTAGE GROUP LIMITED		CARDARELLI ANGELO	66.430
481	AGF EUROPEAN EQUITY FUND		CARDARELLI ANGELO	27.715
2524	AGI FONDS GRILLPARZER		CARDARELLI ANGELO	9.062
2490	AGIPI ACTIONS EUROPE		CARDARELLI ANGELO	389.361
808	AGIRA RETRAITE DIVERSIFIE		CARDARELLI ANGELO	29.734
819	AGIRA RETRAITE DIVERSIFIE		CARDARELLI ANGELO	63.000
750	AGRIPLAN EXPANSION FCPE CAES		CARDARELLI ANGELO	31.579

ASSEMBLEA ORDINARIA 12 MAGGIO 2016

Segreteria Societaria - Ufficio Titoli



eni

Unica convocazione

Esito della votazione sul punto 3

Nomina di un Amministratore ai sensi dell'articolo 2386 del Codice Civile

8160/1170

Elenco Favorevoli

SCHEDA	VPC	NOMINATIVO AZIONISTA	DELEGATO	NUMERO DI AZIONI TOTALE
253		AK STEEL CORPORATION MASTER PENSION TRUST	CARDARELLI ANGELO	15.207
489		ALABAMA TRUST FUND	CARDARELLI ANGELO	75.600
1536		ALAMEDA COUNTY EMPLOYEES' RETIREMENT ASSOCIATION	CARDARELLI ANGELO	633.318
1537		ALAMEDA COUNTY EMPLOYEES' RETIREMENT ASSOCIATION	CARDARELLI ANGELO	60.059
232		ALAS INVESTMENT SERVICES LTD	CARDARELLI ANGELO	62.148
1188		ALASKA COMMON TRUST FUND	CARDARELLI ANGELO	70.885
945		ALASKA ELECTRICAL PENSION PLAN	CARDARELLI ANGELO	86.087
484		ALASKA PERMANENT FUND CORPORATION	CARDARELLI ANGELO	190.800
485		ALASKA PERMANENT FUND CORPORATION	CARDARELLI ANGELO	373.969
486		ALASKA PERMANENT FUND CORPORATION	CARDARELLI ANGELO	23.650
487		ALASKA PERMANENT FUND CORPORATION	CARDARELLI ANGELO	23.956
488		ALASKA PERMANENT FUND CORPORATION	CARDARELLI ANGELO	220.983
934		ALLIANCEBERNST VAR PROD SER F INC.ALLIANCEB DYN ASSET ALL PTF	CARDARELLI ANGELO	15.444
929		ALLIANCEBERNSTEIN BOND F - ALLIANCEBERNSTEIN REAL AS STR	CARDARELLI ANGELO	8.990
933		ALLIANCEBERNSTEIN COLLECTIVE INVESTMENT TRUST SERIES	CARDARELLI ANGELO	639
928		ALLIANCEBERNSTEIN GLOBAL RISK ALLOCATION FUND INC	CARDARELLI ANGELO	7.149
1112		ALLIANCEBERNSTEIN INTERNATIONAL ALL-COUNTRY PASSIVE SERIES	CARDARELLI ANGELO	36.973
728		ALLIANT TECHSYSTEMS INC.DEFINEDBENEFIT MASTER TRUST	CARDARELLI ANGELO	49.624
2561		ALLIANZ FLEXI EURO BALANCE	CARDARELLI ANGELO	125.761
2560		ALLIANZ FLEXI EURO DYNAMIK	CARDARELLI ANGELO	49.691
2559		ALLIANZ FNDVOR 1947 1951	CARDARELLI ANGELO	186.901
2542		ALLIANZ GI FONDS D300	CARDARELLI ANGELO	52.983
2543		ALLIANZ GI FONDS PKM DEGUSSA	CARDARELLI ANGELO	7.569

m

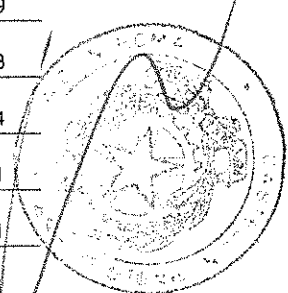

ASSEMBLEA ORDINARIA

81607/141 12 MAGGIO 2016

Segreteria Societaria - Ufficio Titoli



eni

Unica convocazione

Esito della votazione sul punto 3

Nomina di un Amministratore ai sensi dell'articolo 2386 del Codice Civile**Elenco Favorevoli**

SCHEDA	VPC	NOMINATIVO AZIONISTA	DELEGATO	NUMERO DI AZIONI TOTALE
2538		ALLIANZ GI FONDS RANW II	CARDARELLI ANGELO	72.030
950		ALLIANZ GLOBAL INV GMBH FOR ALLIANZGI-FONDS SFT2	CARDARELLI ANGELO	20.592
1258		ALLIANZ GLOBAL INV KAG MBH FOR ALLIANZGI - FONDS A200	CARDARELLI ANGELO	50.000
314		ALLIANZ GLOBAL INVESTORS EUROPEGMBH	CARDARELLI ANGELO	1.047
319		ALLIANZ GLOBAL INVESTORS EUROPEGMBH	CARDARELLI ANGELO	3.235
327		ALLIANZ GLOBAL INVESTORS EUROPEGMBH	CARDARELLI ANGELO	392.196
332		ALLIANZ GLOBAL INVESTORS EUROPEGMBH	CARDARELLI ANGELO	165.230
344		ALLIANZ GLOBAL INVESTORS EUROPEGMBH	CARDARELLI ANGELO	61.810
345		ALLIANZ GLOBAL INVESTORS EUROPEGMBH	CARDARELLI ANGELO	13.964
1361		ALLIANZ GLOBAL INVESTORS FUND	CARDARELLI ANGELO	46.201
1365		ALLIANZ GLOBAL INVESTORS FUND	CARDARELLI ANGELO	59.900
2507		ALLIANZ GLOBAL INVESTORS GMBH	CARDARELLI ANGELO	42.300
3299		ALLIANZ GLOBAL INVESTORS GMBH	CARDARELLI ANGELO	67.000
329		ALLIANZ GLOBAL INVESTORS GMBH ALLIANZ ALD FONDS	CARDARELLI ANGELO	27.409
1263		ALLIANZ GLOBAL INVESTORS GMBH FOR ALLIANZGI-FONDS HPT	CARDARELLI ANGELO	56.773
935		ALLIANZ GLOBAL INVESTORS GMBH FOR DBI-FONDS ANDUS	CARDARELLI ANGELO	70.316
1023		ALLIANZ GLOBAL INVESTORS GMBH FOR ELK-COFONDS	CARDARELLI ANGELO	20.021
1363		ALLIANZ STIFTUNGSFONDS NACHHALTIGKEIT	CARDARELLI ANGELO	21.152
1362		ALLIANZ SUISSE - STRATEGY FUND	CARDARELLI ANGELO	12.685
20		ALLIANZ SUISSE LEBENSVERSICHERUNGS-GESELLSCHAFT AG	CARDARELLI ANGELO	458.369
2555		ALLIANZGI PSDN	CARDARELLI ANGELO	23.000
2578		ALLIANZGI FOND AMMERLAND	CARDARELLI ANGELO	6.559
2546		ALLIANZGI FONDS ACK	CARDARELLI ANGELO	4.627

ASSEMBLEA ORDINARIA 12 MAGGIO 2016

Segreteria Societaria - Ufficio Titoli



eni

Unica convocazione

Esito della votazione sul punto 3

Nomina di un Amministratore ai sensi dell'articolo 2386 del Codice Civile

81607/1172

Elenco Favorevoli

SCHEDA	VPC	NOMINATIVO AZIONISTA	DELEGATO	NUMERO DI AZIONI TOTALE
2552		ALLIANZGI FONDS AEVN	CARDARELLI ANGELO	77.630
2553		ALLIANZGI FONDS AEVN	CARDARELLI ANGELO	20.000
2554		ALLIANZGI FONDS AEVN	CARDARELLI ANGELO	216.147
2545		ALLIANZGI FONDS AFE	CARDARELLI ANGELO	6.186
2562		ALLIANZGI FONDS AFE	CARDARELLI ANGELO	40.040
2575		ALLIANZGI FONDS AFE	CARDARELLI ANGELO	80.469
2539		ALLIANZGI FONDS AKTIEN EUROPA	CARDARELLI ANGELO	79.000
2586		ALLIANZGI FONDS ALCO	CARDARELLI ANGELO	5.000
2533		ALLIANZGI FONDS ALLRA	CARDARELLI ANGELO	5.299
2532		ALLIANZGI FONDS ALPEN	CARDARELLI ANGELO	3.473
2535		ALLIANZGI FONDS APNIESA	CARDARELLI ANGELO	36.931
2536		ALLIANZGI FONDS APNIESA	CARDARELLI ANGELO	116.286
2531		ALLIANZGI FONDS AVP	CARDARELLI ANGELO	262
2530		ALLIANZGI FONDS BSP	CARDARELLI ANGELO	2.809
2591		ALLIANZGI FONDS BVK 1	CARDARELLI ANGELO	45.000
2529		ALLIANZGI FONDS CCS	CARDARELLI ANGELO	7.074
2584		ALLIANZGI FONDS COEN2	CARDARELLI ANGELO	25.000
2548		ALLIANZGI FONDS DBS	CARDARELLI ANGELO	1.492
2528		ALLIANZGI FONDS DIN	CARDARELLI ANGELO	10.000
2537		ALLIANZGI FONDS FEV	CARDARELLI ANGELO	4.076
2527		ALLIANZGI FONDS FIB	CARDARELLI ANGELO	15.600
2526		ALLIANZGI FONDS GANO	CARDARELLI ANGELO	1.494
2525		ALLIANZGI FONDS GANO 2	CARDARELLI ANGELO	3.492

ASSEMBLEA ORDINARIA

81607/443 12 MAGGIO 2016

Segreteria Societaria - Ufficio Titoli



eni

Unica convocazione

Esito della votazione sul punto 3

Nomina di un Amministratore ai sensi dell'articolo 2386 del Codice Civile

Elenco Favorevoli

SCHEDA	VPC	NOMINATIVO AZIONISTA	DELEGATO	NUMERO DI AZIONI TOTALE
2579		ALLIANZGI FONDS GDP	CARDARELLI ANGELO	16.000
2580		ALLIANZGI FONDS GEW	CARDARELLI ANGELO	2.236
2523		ALLIANZGI FONDS HAMONUS	CARDARELLI ANGELO	1.900
2576		ALLIANZGI FONDS HEUST	CARDARELLI ANGELO	8.240
2522		ALLIANZGI FONDS INDU	CARDARELLI ANGELO	7.135
2521		ALLIANZGI FONDS KDCO	CARDARELLI ANGELO	35.000
3027		ALLIANZGI FONDS LANXESS PENSION TRUST1	CARDARELLI ANGELO	16.800
2577		ALLIANZGI FONDS MASTER DRT	CARDARELLI ANGELO	21.500
2544		ALLIANZGI FONDS NASPA PENSIONS FONDS	CARDARELLI ANGELO	17.858
2520		ALLIANZGI FONDS OJU	CARDARELLI ANGELO	1.042
2549		ALLIANZGI FONDS PAK	CARDARELLI ANGELO	1.563
2551		ALLIANZGI FONDS PENSIONS	CARDARELLI ANGELO	17.176
2570		ALLIANZGI FONDS PF1	CARDARELLI ANGELO	13.784
2571		ALLIANZGI FONDS PF1	CARDARELLI ANGELO	11.081
2572		ALLIANZGI FONDS PF1	CARDARELLI ANGELO	18.799
2573		ALLIANZGI FONDS PF1	CARDARELLI ANGELO	19.662
2574		ALLIANZGI FONDS PF1	CARDARELLI ANGELO	22.195
2564		ALLIANZGI FONDS PF2	CARDARELLI ANGELO	10.493
2565		ALLIANZGI FONDS PF2	CARDARELLI ANGELO	37.711
2566		ALLIANZGI FONDS PF2	CARDARELLI ANGELO	17.420
2519		ALLIANZGI FONDS PFD	CARDARELLI ANGELO	1.233
2590		ALLIANZGI FONDS PGD	CARDARELLI ANGELO	15.651
2567		ALLIANZGI FONDS PTV2	CARDARELLI ANGELO	30.322

ASSEMBLEA ORDINARIA 12 MAGGIO 2016

Segreteria Societaria - Ufficio Titoli



eni

Unica convocazione

Esito della votazione sul punto 3

Nomina di un Amministratore ai sensi dell'articolo 2386 del Codice Civile

81607/1174

Elenco Favorevoli

SCHEDA	VPC	NOMINATIVO AZIONISTA	DELEGATO	NUMERO DI AZIONI TOTALE
2568		ALLIANZGI FONDS PTV2	CARDARELLI ANGELO	25.091
2569		ALLIANZGI FONDS PTV2	CARDARELLI ANGELO	27.277
2518		ALLIANZGI FONDS REINVEST	CARDARELLI ANGELO	1.530
2517		ALLIANZGI FONDS SCHLUCCO	CARDARELLI ANGELO	11.000
2582		ALLIANZGI FONDS SIV	CARDARELLI ANGELO	20.000
2550		ALLIANZGI FONDS STIFTUNGSFONDS WISSENSCH	CARDARELLI ANGELO	4.516
2581		ALLIANZGI FONDS SWKA 1	CARDARELLI ANGELO	7.000
2585		ALLIANZGI FONDS TIBUR	CARDARELLI ANGELO	7.090
2557		ALLIANZGI FONDS TOSCA	CARDARELLI ANGELO	7.256
2516		ALLIANZGI FONDS UGF	CARDARELLI ANGELO	12.500
2592		ALLIANZGI FONDS USES	CARDARELLI ANGELO	30.447
2515		ALLIANZGI FONDS VBDK	CARDARELLI ANGELO	7.087
2514		ALLIANZGI FONDS VEMK	CARDARELLI ANGELO	1.409
2589		ALLIANZGI FONDS VSBW	CARDARELLI ANGELO	11.221
2534		ALLIANZGI FONDS VSF	CARDARELLI ANGELO	958
2513		ALLIANZGI FONDS WERT	CARDARELLI ANGELO	5.100
2512		ALLIANZGI FONDS ZUBB	CARDARELLI ANGELO	3.797
1028		ALLIANZGI GLOBAL FUNDAMENTAL STRATEGY FUND	CARDARELLI ANGELO	7.700
2556		ALLIANZGI SHL	CARDARELLI ANGELO	4.970
3028		ALLIANZGI-FONDS DSPT	CARDARELLI ANGELO	67.078
359		ALLSTATE LIFE INS COMPANY OF NY	CARDARELLI ANGELO	22.177
223		ALLSTATE LIFE INSURANCE EUROPEAN EQUITY PF	CARDARELLI ANGELO	47.371
281		ALLSTATE LIFE INSURANCE EUROPEAN EQUITY PF	CARDARELLI ANGELO	205.772

2

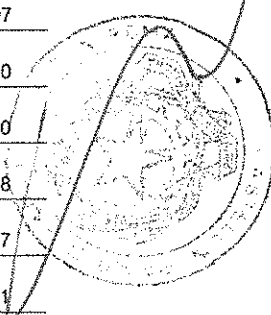

ASSEMBLEA ORDINARIA81607/1475 **12 MAGGIO 2016**

Segreteria Societaria - Ufficio Titoli

**eni**

Unica convocazione

Esito della votazione sul punto 3

Nomina di un Amministratore ai sensi dell'articolo 2386 del Codice Civile

Elenco Favorevoli

SCHEDA	VPC	NOMINATIVO AZIONISTA	DELEGATO	NUMERO DI AZIONI TOTALE
971		ALPS INTERNATIONAL SECTOR DIVIDEND DOGS ETF	CARDARELLI ANGELO	171.597
1750		AMERGEN CLINTON NUCLEAR POWER PLANT NONQUALIFIED FUND	CARDARELLI ANGELO	7.550
343		AMERICAFIRST DEFENSIVE GROWTH FUND	CARDARELLI ANGELO	106.247
1497		AMERICAN AIRLINES INC., MASTER FIXED BENEFIT PENSION TRUST	CARDARELLI ANGELO	266.753
1016		AMERICAN BEACON ADVISORS COLLECTIVE INVESTMENT TRUST	CARDARELLI ANGELO	142.513
1017		AMERICAN BEACON INTERNATIONAL EQUITY FUND	CARDARELLI ANGELO	606.519
958		AMERICAN CENTURY QUANTITATIVE EQUITY FUNDS, INC. INT CORE EQ	CARDARELLI ANGELO	9.542
961		AMERICAN CENTURY RETIREMENT DATE TRUST	CARDARELLI ANGELO	53.488
956		AMERICAN CENTURY STRAT ASSET ALL, INC. STRAT ALL MODERATE F	CARDARELLI ANGELO	66.227
957		AMERICAN CENTURY STRAT ASSET ALL, INC. STRATEGIC ALL AGGR F	CARDARELLI ANGELO	50.290
955		AMERICAN CENTURY STRATEGIC ASSET ALL, INC. STRAT ALL CONS F	CARDARELLI ANGELO	16.623
960		AMERICAN CENTURY WORLD MUTUAL FUNDS INC - NT INT VALUE FUND	CARDARELLI ANGELO	700.772
959		AMERICAN CENTURY WORLD MUTUAL FUNDS, INC. INTL VALUE F	CARDARELLI ANGELO	62.335
467		AMERICAN ELECTRIC POWER MASTER RETIREMENT TRUST	CARDARELLI ANGELO	151.479
468		AMERICAN ELECTRIC POWER MASTER RETIREMENT TRUST	CARDARELLI ANGELO	40.021
515		AMERICAN ELECTRIC POWER SYSTEM RETIREE LIFE INSURANCE TRUST	CARDARELLI ANGELO	18.160
516		AMERICAN ELECTRIC POWER SYSTEM RETIREE MEDICAL TRUST FOR CERTAIN UNION	CARDARELLI ANGELO	35.528
501		AMERICAN FUNDS GLOBAL BALANCED FUND	CARDARELLI ANGELO	3.214.000
1061		AMERICAN FUNDS INSURANCE SERIES CAPITAL INCOME BUILDER	CARDARELLI ANGELO	26.766
1058		AMERICAN FUNDS INSURANCE SERIES GROWTH INCOME FUND	CARDARELLI ANGELO	1.775.727
1060		AMERICAN FUNDS INSURANCE SERIES INT GROWTH AND INCOME FUND	CARDARELLI ANGELO	250.000
1059		AMERICAN FUNDS INSURANCE SERIES INTERNATIONAL FUND	CARDARELLI ANGELO	425.000
394		AMERICAN HEART ASSOCIATION, INC	CARDARELLI ANGELO	12.547

ASSEMBLEA ORDINARIA 12 MAGGIO 2016

Segreteria Societaria - Ufficio Titoli



eni

Unica convocazione

Esito della votazione sul punto 3

Nomina di un Amministratore ai sensi dell'articolo 2386 del Codice Civile

81607/1176

[Handwritten signature]

Elenco Favorevoli

SCHEDA VPC	NOMINATIVO AZIONISTA	DELEGATO	NUMERO DI AZIONI TOTALE
395	AMERICAN HEART ASSOCIATION, INC	CARDARELLI ANGELO	4.054
1893	AMERICAN MEDICAL ASSOCIATION	CARDARELLI ANGELO	58.811
1894	AMERICAN MEDICAL ASSOCIATION	CARDARELLI ANGELO	20.379
3124	AMERIPRISE TRUST COMPANY	CARDARELLI ANGELO	1.889
3270	AMEV Leven Beleggingen	CARDARELLI ANGELO	68.553
3273	AMEV Schade Beleggingen	CARDARELLI ANGELO	20.636
2625	AMP INT EQ IND FD HEDGED	CARDARELLI ANGELO	45.495
2628	AMP INTERNATIONAL EQUITY INDEX FUND	CARDARELLI ANGELO	289.596
160	AMUNDI ACTIONS INTLES SMART BE	CARDARELLI ANGELO	14
816	AMUNDI APOLLINE ACTIONS EUROPE	CARDARELLI ANGELO	139.839
127	AMUNDI ETF SP EUROPE 350	CARDARELLI ANGELO	12.663
213	AMUNDI FUNDS INDEX EQUITY EURO	CARDARELLI ANGELO	11
219	AMUNDI FUNDS INDEX EQUITY JAPAN	CARDARELLI ANGELO	582.308
218	AMUNDI FUNDS INDEX EQUITY WORLD	CARDARELLI ANGELO	18
214	AMUNDI FUNDS INDEX EUROPE ACCOUNT	CARDARELLI ANGELO	31.529
215	AMUNDI FUNDS SELECT EURO	CARDARELLI ANGELO	18
216	AMUNDI FUNDS SELECT EURO	CARDARELLI ANGELO	147
121	AMUNDI SIF EUROPEAN EQUITY INDEX FUND	CARDARELLI ANGELO	840
217	AMUNDI SIF EUROPEAN EQUITY INDEX FUND	CARDARELLI ANGELO	7.342
1090	ANCHOR SERIES TRUST NATURAL RESOURCES PORTFOLIO	CARDARELLI ANGELO	270.201
3211	ANIMA SGR SPA - ANIMA EUROPA	CARDARELLI ANGELO	498.533
3215	ANIMA SGR SPA - FONDO ANIMA GEO EUROPA	CARDARELLI ANGELO	979.851
3216	ANIMA SGR SPA - FONDO ANIMA GEO ITALIA	CARDARELLI ANGELO	2.214.998

[Handwritten signature]

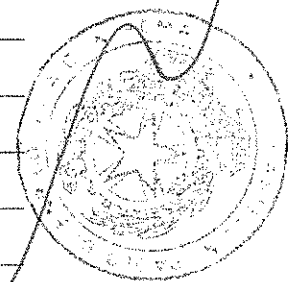

ASSEMBLEA ORDINARIA

81607/1117 12 MAGGIO 2016

Segreteria Societaria - Ufficio Titoli



Unica convocazione

Esito della votazione sul punto 3

Nomina di un Amministratore ai sensi dell'articolo 2386 del Codice Civile

Elenco Favorevoli

SCHEDA	VPC	NOMINATIVO AZIONISTA	DELEGATO	NUMERO DI AZIONI TOTALE
3212		ANIMA SGR SPA - FONDO ANIMA ITALIA	CARDARELLI ANGELO	1.295.288
3214		ANIMA SGR SPA - FONDO ANIMA SFORZESCO	CARDARELLI ANGELO	454.360
3213		ANIMA SGR SPA - FONDO ANIMA VISCONTEO	CARDARELLI ANGELO	791.280
1772		ANNE RAY CHARITABLE TRUST	CARDARELLI ANGELO	56.668
656		AON HEWITT GROUP TRUST	CARDARELLI ANGELO	552.072
2641		APA SOLIDARITE FCP	CARDARELLI ANGELO	3.515
977		AQR COLLECTIVE INVESTMENT TRUST	CARDARELLI ANGELO	47.745
1189		AQR COLLECTIVE INVESTMENT TRUST	CARDARELLI ANGELO	7.470
979		AQR CUSTOMIZED REAL RETURN OFFSHORE FUND, L.P.	CARDARELLI ANGELO	31.991
1653		AQR FUNDS - AQR EQUITY MARKET NEUTRAL FUND	CARDARELLI ANGELO	95.536
2937		AQR FUNDS - AQR INTERNATIONAL DEFENSIVE EQUITY FUND CORPORATION SERVICE COMPANY	CARDARELLI ANGELO	3.488
2956		AQR FUNDS - AQR INTERNATIONAL MULTI-STYLE FUND CORPORATION SERVICE COMPANY	CARDARELLI ANGELO	45.955
3059		AQR FUNDS - AQR INTERNATIONAL MULTI-STYLE FUND CORPORATION SERVICE COMPANY	CARDARELLI ANGELO	5.508
1656		AQR FUNDS - AQR LONG SHORT EQUITY FUND	CARDARELLI ANGELO	125.562
2942		AQR FUNDS AQR TAX-MANAGED INTL MOMENTUM	CARDARELLI ANGELO	36.371
1654		AQR FUNDS- AQR STYLE PREMIA ALTERNATIVE LV FUND	CARDARELLI ANGELO	2.726
1733		AQR GLOBAL ENHANCED EQUITY FUND	CARDARELLI ANGELO	66.199
2943		AQR GLOBAL EQUITY FUND	CARDARELLI ANGELO	22.885
1660		AQR GLOBAL LONG-SHORT QUITY FUND	CARDARELLI ANGELO	45.946
2955		AQR INTERNATIONAL EQUITY FUND	CARDARELLI ANGELO	38.064
978		AQR INTERNATIONAL EQUITY INTEGRATED ALPHA FUND, L.P.	CARDARELLI ANGELO	3.613
3058		AQR INTERNATIONAL MOMENTUM FUND	CARDARELLI ANGELO	74.076
976		AQR MULTI-STYLE OFFSHORE FUND, L.P.	CARDARELLI ANGELO	36.379

ASSEMBLEA ORDINARIA 12 MAGGIO 2016

Segreteria Societaria - Ufficio Titoli

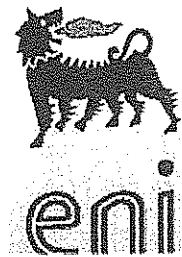

Unica convocazione

Esito della votazione sul punto 3

Nomina di un Amministratore ai sensi dell'articolo 2386 del Codice Civile

81607/478

Elenco Favorevoli

SCHEDA	VPC	NOMINATIVO AZIONISTA	DELEGATO	NUMERO DI AZIONI TOTALE
980		AQR REAL ASSET FUND II, L.P.	CARDARELLI ANGELO	6.706
981		AQR REAL RETURN MASTER ACCOUNT, L.P.	CARDARELLI ANGELO	41.491
1657		AQR Tax Plus U.S. Relaxed Constraint Equity Fund	CARDARELLI ANGELO	755
2778		AQR UCITS FUNDS	CARDARELLI ANGELO	401
1663		ARAB BANK FOR ECONOMIC DEVELOPMENT IN AFRICA	CARDARELLI ANGELO	11.470
2967		ARAB FUND FOR ECONOMIC AND SOCIAL DEVELOPMENT	CARDARELLI ANGELO	6.443
2471		ARABELLE INVESTISSEMENTS	CARDARELLI ANGELO	3.000
557		ARCHDIOCESE OF HARTFORD INVESTMENT TRUST	CARDARELLI ANGELO	2.447
795		AREGE 2IC	CARDARELLI ANGELO	17.132
645		ARIZONA PSPRS TRUST	CARDARELLI ANGELO	121.722
953		ARIZONA STATE RETIREMENT SYSTEM	CARDARELLI ANGELO	206.439
954		ARIZONA STATE RETIREMENT SYSTEM	CARDARELLI ANGELO	1.074.711
2787		ARK LIFE ASSURANCE COMPANY LIMITED	CARDARELLI ANGELO	16.073
3289		ARK LIFE ASSURANCE COMPANY LIMITED	CARDARELLI ANGELO	22.193
3290		ARK LIFE ASSURANCE COMPANY LIMITED	CARDARELLI ANGELO	81.806
3291		ARK LIFE ASSURANCE COMPANY LIMITED	CARDARELLI ANGELO	38.993
3292		ARK LIFE ASSURANCE COMPANY LIMITED	CARDARELLI ANGELO	7.400
875		ARKWRIGHT, LLC	CARDARELLI ANGELO	8.297
2922		ARMSTRONG WORLD INDUSTRIES INC MASTER TR	CARDARELLI ANGELO	48.841
2944		ARMSTRONG WORLD INDUSTRIES INC MASTER TR	CARDARELLI ANGELO	41.197
2249		ARRCO LONG TERME	CARDARELLI ANGELO	70.517
776		ARRCO LONG TERME D ACTIONS	CARDARELLI ANGELO	209.890
2252		ARRCO QUANT 1	CARDARELLI ANGELO	211.619

ASSEMBLEA ORDINARIA81607/419 **12 MAGGIO 2016**

Segreteria Societaria - Ufficio Titoli

**eni**

Unica convocazione

Esito della votazione sul punto 3

Nomina di un Amministratore ai sensi dell'articolo 2386 del Codice Civile**Elenco Favorevoli**

SCHEDA	VPC	NOMINATIVO AZIONISTA	DELEGATO	NUMERO DI AZIONI TOTALE
654		ARROWSTREET COLLECTIVE INVESTMENT TRUST	CARDARELLI ANGELO	84.731
843		ARROWSTREET US GROUP TRUST	CARDARELLI ANGELO	26.665
1839		ASCENSION ALPHA FUND, LLC	CARDARELLI ANGELO	562.869
1521		ASCENSION HEALTH MASTER PENSION TRUST	CARDARELLI ANGELO	314.935
1140		ASHWOOD INVESTMENTS LIMITED	CARDARELLI ANGELO	8.891
1266		ASIAN DEVELOPMENT BANK	CARDARELLI ANGELO	121.217
3267		ASR Euro Aandelen Pool	CARDARELLI ANGELO	261.923
3269		ASR Euro Aandelen Pool (Assets)	CARDARELLI ANGELO	86.473
3266		ASR Europese Aandelen Pool	CARDARELLI ANGELO	52.425
3271		ASR LEVENSVERZEKERING N.V.	CARDARELLI ANGELO	145.145
3154		ASSOCIATION DE BIENFAISANCE ET DE RETRAITE DES POLICIERS ET POLICIERES DE LA VILLE DE M	CARDARELLI ANGELO	47.263
139		ASSURDIX	CARDARELLI ANGELO	18
677		AT&T SAVINGS GROUP INVESTMEN TRUST	CARDARELLI ANGELO	11.242
658		AT&T UNION WELFARE BENEFIT TRUST	CARDARELLI ANGELO	57.053
82		ATLAS ENHANCED MASTER FUND	CARDARELLI ANGELO	1.134.400
80		ATLAS MASTER FUND LTD	CARDARELLI ANGELO	79.052
83		ATLAS MASTER FUND LTD.	CARDARELLI ANGELO	418.627
165		ATOUT EUROLAND	CARDARELLI ANGELO	399.818
162		ATOUT EUROLAND HAUT RENDEMENT	CARDARELLI ANGELO	11
163		ATOUT EUROLAND MIN VAR	CARDARELLI ANGELO	19
164		ATOUT EUROLAND RESTRUCTURATION	CARDARELLI ANGELO	14
156		ATOUT EUROPE RESTRUCTURATION	CARDARELLI ANGELO	12
157		ATOUT EUROPE SELECT	CARDARELLI ANGELO	15

ASSEMBLEA ORDINARIA

12 MAGGIO 2016

Segreteria Societaria - Ufficio Titoli

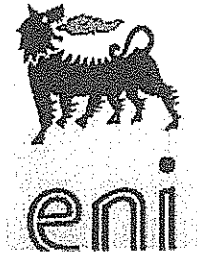

Unica convocazione

Esito della votazione sul punto 3

Nomina di un Amministratore ai sensi dell'articolo 2386 del Codice Civile

81607/1180

Handwritten signature

Elenco Favorevoli

SCHEDA	VPC	NOMINATIVO AZIONISTA	DELEGATO	NUMERO DI AZIONI TOTALE
158		ATOUT EUROPE SMART BETA	CARDARELLI ANGELO	14
142		ATOUT MODERATIONS	CARDARELLI ANGELO	14
133		ATOUT VALEURS DURABLES	CARDARELLI ANGELO	7.971
2017		AUSTRALIA POST SUPERANNUATION SCHEME	CARDARELLI ANGELO	8.597
2629		AUSTRALIAN CATHOLIC SUPERAN RETIREM FUND	CARDARELLI ANGELO	15.669
2478		AVENIR EURO	CARDARELLI ANGELO	180.000
3244		AVIVA INVEST MANAGER ICVC EURO EQUITY MO	CARDARELLI ANGELO	118.976
25		AVIVA INVESTORS INTERNATIONAL INDEX TRACKING FUND	CARDARELLI ANGELO	45.924
3235		AVIVA LIFE & PENSIONS UK LIMITED	CARDARELLI ANGELO	143.188
3236		AVIVA LIFE & PENSIONS UK LIMITED	CARDARELLI ANGELO	129.498
3237		AVIVA LIFE & PENSIONS UK LIMITED	CARDARELLI ANGELO	92.347
3240		AVIVA LIFE AND PENSIONS UK LIMITED	CARDARELLI ANGELO	106.592
3241		AVIVA LIFE AND PENSIONS UK LIMITED	CARDARELLI ANGELO	73.298
2886		AXA EQUITABLE LIFE INSURANCE CO	CARDARELLI ANGELO	3.830
2909		AXA EQUITABLE LIFE INSURANCE CO	CARDARELLI ANGELO	35.622
2487		AXA GENERATION EQUILIBRE 2 FCPE	CARDARELLI ANGELO	278.500
3045		AXA IRELAND PENSION FUND	CARDARELLI ANGELO	45.000
983		AXA ROSENBERG EQUITY ALPHA TRUST	CARDARELLI ANGELO	5.000
2492		AXA VALEURS EURO	CARDARELLI ANGELO	200.000
1354		AXA WORLD FUNDS	CARDARELLI ANGELO	2.500.000
1355		AXA WORLD FUNDS	CARDARELLI ANGELO	15.381
1356		AXA WORLD FUNDS	CARDARELLI ANGELO	48.095
1357		AXA WORLD FUNDS	CARDARELLI ANGELO	930.000

Handwritten mark

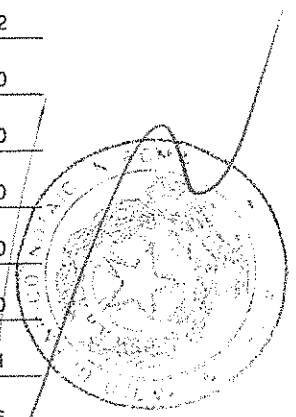

ASSEMBLEA ORDINARIA

81607/4181 12 MAGGIO 2016

Segreteria Sociaria - Ufficio Titoli



eni

Unica convocazione

Esito della votazione sul punto 3

Nomina di un Amministratore ai sensi dell'articolo 2386 del Codice Civile

Elenco Favorevoli

SCHEDA	VPC	NOMINATIVO AZIONISTA	DELEGATO	NUMERO DI AZIONI TOTALE
1358		AXA WORLD FUNDS	CARDARELLI ANGELO	1.000.000
1359		AXA WORLD FUNDS	CARDARELLI ANGELO	304.673
1360		AXA WORLD FUNDS	CARDARELLI ANGELO	650.463
3029		AXA-EB 510	CARDARELLI ANGELO	7.200
490		AZL FRANKLIN TEMPLETON FOUNDINGSTRATEGY PLUS FUND	CARDARELLI ANGELO	112.900
491		AZL INTERNATIONAL INDEX FUND	CARDARELLI ANGELO	122.667
3272		Amersf Alg Beleggingen inzake AOV	CARDARELLI ANGELO	29.879
2511		BAD COFONDS	CARDARELLI ANGELO	19.952
2510		BAD COFONDS II	CARDARELLI ANGELO	3.703
1751		BAE SYSTEMS PENSION FUNDS COMMON INVESTMENT FUND	CARDARELLI ANGELO	259.464
227		BANCO BILBAO VIZCAYA ARGENTARIASA	CARDARELLI ANGELO	65.949
233		BANCO BILBAO VIZCAYA ARGENTARIASA	CARDARELLI ANGELO	495.853
2864		BANCO CENTRAL DE TIMOR EST	CARDARELLI ANGELO	219.738
2865		BANCO CENTRAL DE TIMOR EST	CARDARELLI ANGELO	222.368
229		BANCO NACIONAL DE PANAMA AS TRUSTEE OF FIDEICOMISO FONDO DEAHORRO DE PANAMA	CARDARELLI ANGELO	12.062
1801		BANK NEGARA MALAYSIA	CARDARELLI ANGELO	228.105
1863		BANK OF BOTSWANA	CARDARELLI ANGELO	68.192
1864		BANK OF BOTSWANA	CARDARELLI ANGELO	20.072
1205		BANK OF KOREA	CARDARELLI ANGELO	142.864
1206		BANK OF KOREA	CARDARELLI ANGELO	47.229
1212		BANK OF KOREA	CARDARELLI ANGELO	76.784
1949		BANNER HEALTH	CARDARELLI ANGELO	199.611
2724		BANQUE PICTET & CIE SA	CARDARELLI ANGELO	117.209

ASSEMBLEA ORDINARIA 12 MAGGIO 2016

Segreteria Societaria - Ufficio Titoli



[Handwritten signature]

81607/1182

Unica convocazione

Esito della votazione sul punto 3

Nomina di un Amministratore ai sensi dell'articolo 2386 del Codice Civile

Elenco Favorevoli

SCHEDA	VPC	NOMINATIVO AZIONISTA	DELEGATO	NUMERO DI AZIONI TOTALE
2725		BANQUE PICTET & CIE SA	CARDARELLI ANGELO	33.970
2727		BANQUE PICTET & CIE SA	CARDARELLI ANGELO	24.871
2729		BANQUE PICTET & CIE SA	CARDARELLI ANGELO	51.052
493		BAPTIST FOUNDATION OF TEXAS .	CARDARELLI ANGELO	143.427
494		BAPTIST FOUNDATION OF TEXAS .	CARDARELLI ANGELO	47.799
3113		BAPTIST HEALTH SOUTH FLORIDA INC	CARDARELLI ANGELO	248.427
2059		BARING COMPONENT FUNDS	CARDARELLI ANGELO	303.904
714		BARROW HANLEY MEWHINNEY & STRA	CARDARELLI ANGELO	7.810
2347		BAYERNINVEST KAPITALVERWALTUNGSGESELLSCHAFT MBH	CARDARELLI ANGELO	113.861
2345		BAYERNINVEST KVG MBH	CARDARELLI ANGELO	1.238.075
3294		BAYERNINVEST KVG MBH	CARDARELLI ANGELO	46.785
3295		BAYERNINVEST KVG MBH	CARDARELLI ANGELO	6.080
2595		BAYVK A4 FONDS	CARDARELLI ANGELO	22.883
2596		BAYVK G1 BVK INDEX	CARDARELLI ANGELO	159.633
2594		BAYVK G2 FONDS	CARDARELLI ANGELO	238.611
3202		BBH & CO BOSTON CUSTODIAN FOR FIDELITY GROUP TRUST FOR THE EMPLOYEE BENEFIT PLANS -	CARDARELLI ANGELO	72.500
3204		BBH CO BOSTON CUSTODIAN FOR GALLERY TRUST - MONDRIAN INTERNATIONAL EQUITY FUND	CARDARELLI ANGELO	527.260
3201		BBH CONTRAFUND FIDELITY ADVISOR SERIES OPPORTUNISTIC INSIGHTS FUND	CARDARELLI ANGELO	5.600
3205		BBH FOR FIDELITY SERIES OPPORTUNISTIC INSIGHTS FUND	CARDARELLI ANGELO	38.800
2357		BBH INTERNATIONAL EQUITY FUND	CARDARELLI ANGELO	656.061
2385		BBH INTERNATIONAL EQUITY MASTER	CARDARELLI ANGELO	86.515
2241		BBH TRUSTEE SERVICES	CARDARELLI ANGELO	4.980
1802		BEAT DRUGS FUND ASSOCIATION	CARDARELLI ANGELO	3.544

[Handwritten signature]

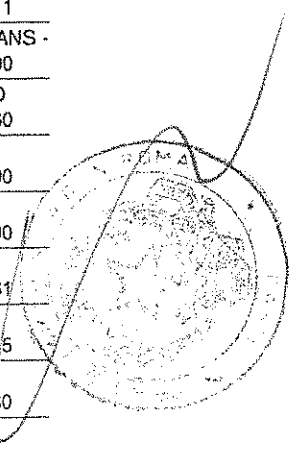

ASSEMBLEA ORDINARIA

81607/283 12 MAGGIO 2016

Segreteria Societaria - Ufficio Titoli



eni

Unica convocazione

Esito della votazione sul punto 3

Nomina di un Amministratore ai sensi dell'articolo 2386 del Codice Civile**Elenco Favorevoli**

SCHEDA	VPC	NOMINATIVO AZIONISTA	DELEGATO	NUMERO DI AZIONI TOTALE
2858		BELEGGINGSFONDS BELCENA	CARDARELLI ANGELO	62.082
627		BELL ATLANTIC MASTER TRUST	CARDARELLI ANGELO	198.668
628		BELL ATLANTIC MASTER TRUST	CARDARELLI ANGELO	23.553
629		BELL ATLANTIC MASTER TRUST	CARDARELLI ANGELO	26.504
630		BELL ATLANTIC MASTER TRUST	CARDARELLI ANGELO	127.549
631		BELL ATLANTIC MASTER TRUST	CARDARELLI ANGELO	40.838
496		BELLSOUTH CORPORATION RFA VEBA TRUST	CARDARELLI ANGELO	67.506
40		BERESFORD FUNDS PLC	CARDARELLI ANGELO	663.506
2823		BEROLINARENT DEKA	CARDARELLI ANGELO	5.100
2426		BEST INVESTMENT CORPORATION	CARDARELLI ANGELO	50.499
3172		BF AND M LIFE INSURANCE COMPANY LTD	CARDARELLI ANGELO	17.543
1462		BGI MSCI EAFE EQUITY INDEX NON-LENDABLE FUND B	CARDARELLI ANGELO	879.040
1463		BGI MSCI EMU IMI INDEX FUND B	CARDARELLI ANGELO	2.303
1461		BGI MSCI EUROPE EQUITY INDEX FUND B	CARDARELLI ANGELO	813.525
1208		BIMCOR GLOBAL EQUITY POOLED FUND	CARDARELLI ANGELO	92.482
1209		BIMCOR GLOBAL EQUITY POOLED FUND	CARDARELLI ANGELO	1.325
1207		BIMCOR OVERSEAS POOLED FUND	CARDARELLI ANGELO	88.706
2849		BIRELEY'S ORANGE JAPAN, S.A.	CARDARELLI ANGELO	1.908
1637		BLACKROCK AM DE AG FOR ISHARES EURO STOXX 50 UCITS ETF (DE)	CARDARELLI ANGELO	7.497.571
1639		BLACKROCK AM DE FOR ISHARES EURO STOXX UCITS ETF (DE)	CARDARELLI ANGELO	915.841
1640		BLACKROCK AM DE FOR ISHARES STOXX EUROPE 50 UCITS ETF (DE)	CARDARELLI ANGELO	269.374
1643		BLACKROCK AM DE FOR ISHARES STOXX EUROPE 600 UCITS ETF (DE)	CARDARELLI ANGELO	1.927.504
1638		BLACKROCK AM DE FOR ISHS DJ EUROZONE SUST SCR. UCITS ETF (DE)	CARDARELLI ANGELO	232.886

ASSEMBLEA ORDINARIA

12 MAGGIO 2016

Segreteria Societaria - Ufficio Titoli



eni

L...

Unica convocazione

Esito della votazione sul punto 3

Nomina di un Amministratore ai sensi dell'articolo 2386 del Codice Civile

81607/1184

Elenco Favorevoli

SCHEDA	VPC	NOMINATIVO AZIONISTA	DELEGATO	NUMERO DI AZIONI TOTALE
1641		BLACKROCK AM DE FOR ISHS STOXX EUROPE LARGE 200 UCITS ETF (DE)	CARDARELLI ANGELO	22.251
1649		BLACKROCK AM SCHWEIZ AG OBO BIFS WORLD EX SWITZ EQ INDEX FUND	CARDARELLI ANGELO	11.954
1444		BLACKROCK CDN MSCI EAFE EQUITY INDEX FUND	CARDARELLI ANGELO	743.904
1447		BLACKROCK CDN MSCI EAFE INDEX PLUS FUND	CARDARELLI ANGELO	20.688
1446		BLACKROCK CDN WORLD INDEX FUND	CARDARELLI ANGELO	102.760
425		BLACKROCK COMMODITIES INCOME INVESTMENT TRUST PLC	CARDARELLI ANGELO	195.450
2878		BLACKROCK FISSION INDEXED INTL EQUITY FD	CARDARELLI ANGELO	79.752
443		BLACKROCK FUNDS ALL-CAP ENERGY AND RESOURCES PORTFOLIO	CARDARELLI ANGELO	157.400
310		BLACKROCK FUNDS GLOBAL OPPORTUNITIES PORTFOLIO	CARDARELLI ANGELO	112.400
300		BLACKROCK FUNDS INTERNATIONAL OPPORTUNITIES PORTFOLIO	CARDARELLI ANGELO	716.800
441		BLACKROCK GLOBAL ENERGY AND RESOURCES TRUST	CARDARELLI ANGELO	533.450
246		BLACKROCK GLOBAL FUNDS	CARDARELLI ANGELO	126.920
247		BLACKROCK GLOBAL FUNDS	CARDARELLI ANGELO	13.954
460		BLACKROCK GLOBAL FUNDS	CARDARELLI ANGELO	11.342
461		BLACKROCK GLOBAL FUNDS	CARDARELLI ANGELO	2.498.050
1372		BLACKROCK GLOBAL INDEX FUNDS	CARDARELLI ANGELO	51.579
1373		BLACKROCK GLOBAL INDEX FUNDS	CARDARELLI ANGELO	137.710
252		BLACKROCK GLOBAL OPPORTUNITIES EQUITY TRUST	CARDARELLI ANGELO	445.200
220		BLACKROCK GLOBAL OPPORTUNITIES V.I. FUND OF BLACKROCK VARIABLESERIES FUNDS, INC	CARDARELLI ANGELO	18.795
2793		BLACKROCK INDEX SELECTION FUND	CARDARELLI ANGELO	980.534
2794		BLACKROCK INDEX SELECTION FUND	CARDARELLI ANGELO	829.078
2795		BLACKROCK INDEX SELECTION FUND	CARDARELLI ANGELO	46.889
2796		BLACKROCK INDEX SELECTION FUND	CARDARELLI ANGELO	124.417

L...

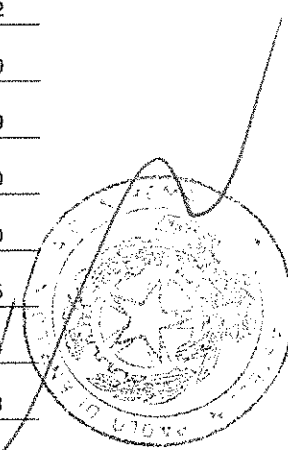

ASSEMBLEA ORDINARIA

81607/285 12 MAGGIO 2016

Segreteria Societaria - Ufficio Titoli



eni

Unica convocazione

Esito della votazione sul punto 3

Nomina di un Amministratore ai sensi dell'articolo 2386 del Codice Civile**Elenco Favorevoli**

SCHEDA	VPC	NOMINATIVO AZIONISTA	DELEGATO	NUMERO DI AZIONI TOTALE
2797		BLACKROCK INDEX SELECTION FUND	CARDARELLI ANGELO	15.588
2876		BLACKROCK INDEXED ALL-COUNTRY EQUITY FUN	CARDARELLI ANGELO	12.916
1419		BLACKROCK INST TRUST CO NA INV FUNDSFOR EMPLOYEE BENEFIT TR	CARDARELLI ANGELO	4.131.318
1420		BLACKROCK INST TRUST CO NA INV FUNDSFOR EMPLOYEE BENEFIT TR	CARDARELLI ANGELO	447.896
1421		BLACKROCK INST TRUST CO NA INV FUNDSFOR EMPLOYEE BENEFIT TR	CARDARELLI ANGELO	272.700
1422		BLACKROCK INST TRUST CO NA INV FUNDSFOR EMPLOYEE BENEFIT TR	CARDARELLI ANGELO	45.700
1434		BLACKROCK INST TRUST CO NA INV FUNDSFOR EMPLOYEE BENEFIT TR	CARDARELLI ANGELO	8.226.494
1435		BLACKROCK INST TRUST CO NA INV FUNDSFOR EMPLOYEE BENEFIT TR	CARDARELLI ANGELO	75.619
1436		BLACKROCK INST TRUST CO NA INV FUNDSFOR EMPLOYEE BENEFIT TR	CARDARELLI ANGELO	449.031
1437		BLACKROCK INST TRUST CO NA INV FUNDSFOR EMPLOYEE BENEFIT TR	CARDARELLI ANGELO	3.941
1438		BLACKROCK INST TRUST CO NA INV FUNDSFOR EMPLOYEE BENEFIT TR	CARDARELLI ANGELO	2.735.316
1439		BLACKROCK INST TRUST CO NA INV FUNDSFOR EMPLOYEE BENEFIT TR	CARDARELLI ANGELO	238.680
1442		BLACKROCK INST TRUST CO NA INV FUNDSFOR EMPLOYEE BENEFIT TR	CARDARELLI ANGELO	4.406
1443		BLACKROCK INST TRUST CO NA INV FUNDSFOR EMPLOYEE BENEFIT TR	CARDARELLI ANGELO	19.745
1448		BLACKROCK INST TRUST CO NA INV FUNDSFOR EMPLOYEE BENEFIT TR	CARDARELLI ANGELO	83.068
1449		BLACKROCK INST TRUST CO NA INV FUNDSFOR EMPLOYEE BENEFIT TR	CARDARELLI ANGELO	3.715.356
1450		BLACKROCK INST TRUST CO NA INV FUNDSFOR EMPLOYEE BENEFIT TR	CARDARELLI ANGELO	337.617
1451		BLACKROCK INST TRUST CO NA INV FUNDSFOR EMPLOYEE BENEFIT TR	CARDARELLI ANGELO	366.126
1452		BLACKROCK INST TRUST CO NA INV FUNDSFOR EMPLOYEE BENEFIT TR	CARDARELLI ANGELO	29.157
2786		BLACKROCK INSTITUTIONAL JERSEY FUNDS	CARDARELLI ANGELO	21.033
2798		BLACKROCK INSTITUTIONAL POOLED FUNDS PLC	CARDARELLI ANGELO	15.203
2799		BLACKROCK INSTITUTIONAL POOLED FUNDS PLC	CARDARELLI ANGELO	4.881
2873		BLACKROCK INTERNATIONAL ALPHA TILTS FUND	CARDARELLI ANGELO	81.298

ASSEMBLEA ORDINARIA 12 MAGGIO 2016

Segreteria Societaria - Ufficio Titoli



[Handwritten signature]

Unica convocazione

Esito della votazione sul punto 3

Nomina di un Amministratore ai sensi dell'articolo 2386 del Codice Civile

81607/1186

Elenco Favorevoli

SCHEDA VPC	NOMINATIVO AZIONISTA	DELEGATO	NUMERO DI AZIONI TOTALE
255	BLACKROCK INTERNATIONAL GROWTH AND INCOME TRUST	CARDARELLI ANGELO	543.200
320	BLACKROCK LIFE LIMITED	CARDARELLI ANGELO	5.869.339
321	BLACKROCK LIFE LIMITED	CARDARELLI ANGELO	63.052
322	BLACKROCK LIFE LIMITED	CARDARELLI ANGELO	13.610
323	BLACKROCK LIFE LIMITED	CARDARELLI ANGELO	58.043
324	BLACKROCK LIFE LIMITED	CARDARELLI ANGELO	402.776
325	BLACKROCK LIFE LIMITED	CARDARELLI ANGELO	659.011
326	BLACKROCK LIFE LIMITED	CARDARELLI ANGELO	178.779
293	BLACKROCK MANAGED VOLATILITY V.I. FUND OF BLACKROCK VARIABLESERIES FUNDS INC	CARDARELLI ANGELO	27.567
1466	BLACKROCK MSCI EUROPE EQUITY ESG SCREENED INDEX FUND B	CARDARELLI ANGELO	80.270
1467	BLACKROCK MSCI WORLD EQUITY ESG SCREENED INDEX FUND B	CARDARELLI ANGELO	207.818
1418	BLACKROCK MSCI WORLD INDEX FUND OF BLACKROCK FUNDS	CARDARELLI ANGELO	19.323
2792	BLACKROCK SELECTION FUND	CARDARELLI ANGELO	230.420
1369	BLACKROCK STRATEGIC FUNDS	CARDARELLI ANGELO	17.699
1370	BLACKROCK STRATEGIC FUNDS	CARDARELLI ANGELO	4.152
1371	BLACKROCK STRATEGIC FUNDS	CARDARELLI ANGELO	14.619
2912	BLACKROCK WHOLESALE INDEXED INTERNATIONA	CARDARELLI ANGELO	159.922
1895	BLUE SHIELD OF CALIFORNIA EMPLOYEES' RETIREMENT PLAN	CARDARELLI ANGELO	58.669
1885	BLUE SKY GROUP	CARDARELLI ANGELO	195.324
1886	BLUE SKY GROUP	CARDARELLI ANGELO	289.450
575	BMO MSCI EAFE HEDGED TO CAD INDEX E	CARDARELLI ANGELO	12.408
236	BNM T&D (UK) LIMITED AS TTEE OFBR DYNAMIC DIV. GROWTH FUND	CARDARELLI ANGELO	11.263
2253	BNP PAM	CARDARELLI ANGELO	347.259

[Handwritten signature]

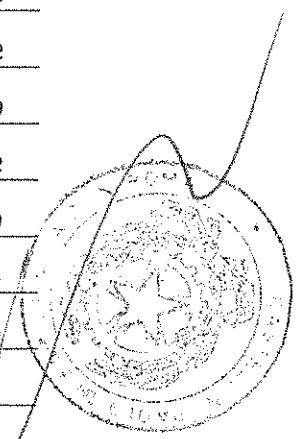

ASSEMBLEA ORDINARIA

81607/1487 12 MAGGIO 2016

Segreteria Societaria - Ufficio Titoli

**eni**

Unica convocazione

Esito della votazione sul punto 3

Nomina di un Amministratore ai sensi dell'articolo 2386 del Codice Civile

Elenco Favorevoli

SCHEDA	VPC	NOMINATIVO AZIONISTA	DELEGATO	NUMERO DI AZIONI TOTALE
2612		BNP PARIBAS A FUND	CARDARELLI ANGELO	49.441
207		BNP PARIBAS APOLLINE ACTIONS EURO	CARDARELLI ANGELO	266.969
2606		BNP PARIBAS B INVEST	CARDARELLI ANGELO	10.909
2607		BNP PARIBAS B INVEST	CARDARELLI ANGELO	13.794
2604		BNP PARIBAS B PENSION BALANCED	CARDARELLI ANGELO	118.242
2617		BNP PARIBAS B PENSION BALANCED	CARDARELLI ANGELO	689.615
2605		BNP PARIBAS B PENSION STABILITY	CARDARELLI ANGELO	48.393
2433		BNP PARIBAS FLOREAL 30	CARDARELLI ANGELO	57.774
2432		BNP PARIBAS FLOREAL 70	CARDARELLI ANGELO	61.437
2608		BNP PARIBAS FUND I	CARDARELLI ANGELO	312.352
2609		BNP PARIBAS FUND III NV	CARDARELLI ANGELO	4.354
2616		BNP PARIBAS FUND III NV	CARDARELLI ANGELO	1.229
2461		BNP PARIBAS INDICE EURO	CARDARELLI ANGELO	506.705
2600		BNP PARIBAS L1	CARDARELLI ANGELO	24.880
2601		BNP PARIBAS L1	CARDARELLI ANGELO	623.130
2602		BNP PARIBAS L1	CARDARELLI ANGELO	937.878
2610		BNP PARIBAS L1	CARDARELLI ANGELO	734.065
2611		BNP PARIBAS L1	CARDARELLI ANGELO	55.431
2613		BNP PARIBAS L1	CARDARELLI ANGELO	127.799
610		BNY MELLON CORP RETIREMENT PLANS MASTER TRUST	CARDARELLI ANGELO	81.695
543		BNY MELLON EMPLOYEE BENEFIT COLLECTIVE INVESTMENT FUND PLAN	CARDARELLI ANGELO	190.605
601		BNY MELLON EMPLOYEE BENEFIT COLLECTIVE INVESTMENT FUND PLAN	CARDARELLI ANGELO	235.704
602		BNY MELLON EMPLOYEE BENEFIT COLLECTIVE INVESTMENT FUND PLAN	CARDARELLI ANGELO	1.343.866

ASSEMBLEA ORDINARIA 12 MAGGIO 2016

Segreteria Societaria - Ufficio Titoli



Unica convocazione

Esito della votazione sul punto 3

Nomina di un Amministratore ai sensi dell'articolo 2386 del Codice Civile

81607/1188

Elenco Favorevoli

SCHEDA	VPC	NOMINATIVO AZIONISTA	DELEGATO	NUMERO DI AZIONI TOTALE
603		BNY MELLON EMPLOYEE BENEFIT COLLECTIVE INVESTMENT FUND PLAN	CARDARELLI ANGELO	231.184
373		BNY MELLON FUNDS TRUST BNY MELLON INTL EQUITY INCOME FUND	CARDARELLI ANGELO	36.105
1685		BNY MELLON T+D (UK) ATF ST. JAMES'S PLACE HIGH OCTANE UNIT TR	CARDARELLI ANGELO	851.337
1686		BNY MELLON TR+DEP ATF ST. JAMES'S PLACE GLOBAL EQ UNIT TR	CARDARELLI ANGELO	130.894
1717		BNY MELLON TR+DEP ATF ST. JAMES'S PLACE MNGD GROWTH UNIT TR	CARDARELLI ANGELO	812.022
365		BNY MELLON TRUST AND DEPOSITARY(UK) LTD AS TRUSTEE OF BLACKROCKSYSTEMATIC CONTINE	CARDARELLI ANGELO	4.682
235		BNYMTD (UK) AS TRUSTEE OF BLACKROCK CONTINENTAL EUROPE EQUITY TRY TRACKER FUND	CARDARELLI ANGELO	1.875.483
234		BNYMTD (UK) LTD AS TRUSTEE OF BLACKROCK GLOBAL EQUITY FUNDEQUITY FUND	CARDARELLI ANGELO	72.500
371		BOC PENSION INVESTMENT FUND .	CARDARELLI ANGELO	27.995
2621		BPCB DPF ECCLESTON G	CARDARELLI ANGELO	51.569
435		BPL	CARDARELLI ANGELO	1.153.143
1149		BRANDES CANADA GLOBAL EQUITY UNIT TRUST	CARDARELLI ANGELO	39.700
1148		BRANDES CANADA INTERNATIONAL EQUITY UNIT TRUST	CARDARELLI ANGELO	516.432
1567		BRANDES GLOBAL BALANCED FUND	CARDARELLI ANGELO	28.955
893		BRANDES GLOBAL EQUITY FUND	CARDARELLI ANGELO	51.677
1569		BRANDES GLOBAL EQUITY FUND	CARDARELLI ANGELO	387.452
895		BRANDES GLOBAL EQUITY INCOME FUND	CARDARELLI ANGELO	1.184
1150		BRANDES GLOBAL OPPORTUNITIES FUND	CARDARELLI ANGELO	133.008
894		BRANDES GLOBAL OPPORTUNITIES VALUE FUND	CARDARELLI ANGELO	7.826
1820		BRANDES INSTITUTIONAL EQUITY TRUST	CARDARELLI ANGELO	912.203
1821		BRANDES INSTITUTIONAL EQUITY TRUST	CARDARELLI ANGELO	122.949
1822		BRANDES INSTITUTIONAL EQUITY TRUST	CARDARELLI ANGELO	12.933
1865		BRANDES INSTITUTIONAL EQUITY TRUST	CARDARELLI ANGELO	29.200

ASSEMBLEA ORDINARIA

81607/2189 12 MAGGIO 2016

Segreteria Societaria - Ufficio Titoli



eni

Unica convocazione

Esito della votazione sul punto 3

Nomina di un Amministratore ai sensi dell'articolo 2386 del Codice Civile**Elenco Favorevoli**

SCHEDA	VPC	NOMINATIVO AZIONISTA	DELEGATO	NUMERO DI AZIONI TOTALE
1866		BRANDES INSTITUTIONAL EQUITY TRUST	CARDARELLI ANGELO	2.070
1488		BRANDES INSTITUTIONAL INTERNATIONAL EQUITY FUND	CARDARELLI ANGELO	1.147.284
1568		BRANDES INTERNATIONAL EQUITY FUND	CARDARELLI ANGELO	281.300
987		BRANDES INVESTMENT FUNDS PLC	CARDARELLI ANGELO	275.364
988		BRANDES INVESTMENT FUNDS PLC	CARDARELLI ANGELO	1.056.022
1950		BRANDES INVESTMENT PARTNERS, LP 401(K) PLAN	CARDARELLI ANGELO	15.875
1951		BRANDES INVESTMENT PARTNERS, LP 401(K) PLAN	CARDARELLI ANGELO	12.800
444		BRIDGE BUILDER INTERNATIONAL EQUITY FUND	CARDARELLI ANGELO	623.547
445		BRIDGE BUILDER INTERNATIONAL EQUITY FUND	CARDARELLI ANGELO	21.198
465		BRIDGEWATER TAILORED ALL WEATHER FUND, L.P	CARDARELLI ANGELO	907.833
1897		BRISTOL-MYERS SQUIBB COMPANY MASTER RETIREMENT TRUST	CARDARELLI ANGELO	39.659
3148		BRITISH COLUMBIA INV.MAN.CORPORATION	CARDARELLI ANGELO	124.098
3149		BRITISH COLUMBIA INV.MAN.CORPORATION	CARDARELLI ANGELO	135.522
3150		BRITISH COLUMBIA INV.MAN.CORPORATION	CARDARELLI ANGELO	1.118.791
3151		BRITISH COLUMBIA INV.MAN.CORPORATION	CARDARELLI ANGELO	581.121
3203		BROWN BROTHERS HARRIMAN + CO, BOSTON CUSTODIAN FOR THE ADVISORS' INNER CIRCLE FUNI	CARDARELLI ANGELO	55.888
1667		BRUNEI INVESTMENT AGENCY	CARDARELLI ANGELO	75.061
1678		BRUNEI INVESTMENT AGENCY	CARDARELLI ANGELO	150.840
2848		BRUNEI SHELL RETIREMENT BENEFIT FUND	CARDARELLI ANGELO	15.379
416		BRUNSWICK UNIT 2 QUALIFIED NUCLEAR DECOMMISSIONING FUND	CARDARELLI ANGELO	6.991
2906		BT EUROPEAN GROWTH FUND	CARDARELLI ANGELO	73.904
2910		BT INSTITUTIONAL CORE GLOBAL SHARE SECTO	CARDARELLI ANGELO	65.435
2908		BT INSTITUTIONAL INTERNATIONAL SHARE INT	CARDARELLI ANGELO	157.265

ASSEMBLEA ORDINARIA 12 MAGGIO 2016

Segreteria Societaria - Ufficio Titoli



[Handwritten signature]

Unica convocazione

Esito della votazione sul punto 3

Nomina di un Amministratore ai sensi dell'articolo 2386 del Codice Civile

81607/UR0

Elenco Favorevoli

SCHEDA	VPC	NOMINATIVO AZIONISTA	DELEGATO	NUMERO DI AZIONI TOTALE
1731		BT INSTITUTIONAL INTERNATIONAL SUSTAINABILITY SHARE FUND	CARDARELLI ANGELO	74.802
2905		BT INTERNATIONAL FUND	CARDARELLI ANGELO	47.069
2907		BT WHOLESALE CORE HEDGED GLOBAL SHARE FU	CARDARELLI ANGELO	17.693
2879		BT WHOLESALE MULTI MANAG INTL SHARE FUND	CARDARELLI ANGELO	63.476
3062		BUREAU OF LABOR FUNDS- LABOR PENSION FUND	CARDARELLI ANGELO	8.614
3063		BUREAU OF LABOR FUNDS- LABOR PENSION FUND	CARDARELLI ANGELO	48.447
3069		BUREAU OF LABOR FUNDS- LABOR PENSION FUND	CARDARELLI ANGELO	123.246
3070		BUREAU OF LABOR FUNDS- LABOR PENSION FUND	CARDARELLI ANGELO	132.622
3071		BUREAU OF LABOR FUNDS- LABOR PENSION FUND	CARDARELLI ANGELO	33.336
3072		BUREAU OF LABOR FUNDS- LABOR PENSION FUND	CARDARELLI ANGELO	21.329
3064		BUREAU OF LABOR FUNDS-LABOR INSURANCE FUND	CARDARELLI ANGELO	41.718
3065		BUREAU OF LABOR FUNDS-LABOR INSURANCE FUND	CARDARELLI ANGELO	86.300
3066		BUREAU OF LABOR FUNDS-LABOR INSURANCE FUND	CARDARELLI ANGELO	81.839
3067		BUREAU OF LABOR FUNDS-LABOR INSURANCE FUND	CARDARELLI ANGELO	76.065
3068		BUREAU OF LABOR FUNDS-LABOR INSURANCE FUND	CARDARELLI ANGELO	83.216
3074		BUREAU OF LABOR FUNDS-LABOR PENSION FUN	CARDARELLI ANGELO	26.616
3075		BUREAU OF LABOR FUNDS-LABOR PENSION FUN	CARDARELLI ANGELO	65.564
419		BURNSWICK UNIT 1 QUALIFIED NUCLEAR DECOMMISSIONING FUND	CARDARELLI ANGELO	7.979
134		CAAM ACTIONS DURABLES	CARDARELLI ANGELO	12
130		CAAM ACTIONS RESTRUCTURATIONS	CARDARELLI ANGELO	21.715
140		CAAM RESA ACTIONS EURO	CARDARELLI ANGELO	46.000
131		CAAM SELECT EURO	CARDARELLI ANGELO	11
1014		CAISSE DE DEPOT ET PLACEMENT DU QUEBEC	CARDARELLI ANGELO	1.567.426

[Handwritten signature]

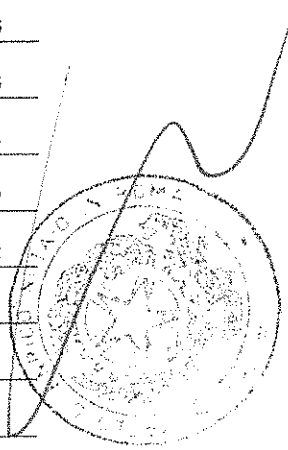

ASSEMBLEA ORDINARIA

81607/1091 12 MAGGIO 2016

Segreteria Societaria - Ufficio Titoli



eni

Unica convocazione

Esito della votazione sul punto 3

Nomina di un Amministratore ai sensi dell'articolo 2386 del Codice Civile

Elenco Favorevoli

SCHEDA	VPC	NOMINATIVO AZIONISTA	DELEGATO	NUMERO DI AZIONI TOTALE
1015		CAISSE DE DEPOT ET PLACEMENT DU QUEBEC	CARDARELLI ANGELO	12.472.800
2499		CAISSE DES DEPOTS ET CONSIGNATIONS	CARDARELLI ANGELO	9.653.819
2500		CAISSE DES DEPOTS ET CONSIGNATIONS	CARDARELLI ANGELO	7.142.529
1896		CALIFORNIA PHYSICIANS SERVICE D/B/A BLUE SHIELD OF CALIFORNIA	CARDARELLI ANGELO	134.067
1237		CALIFORNIA PUBLIC EMPLOYEES RETIREMENT SYSTEM	CARDARELLI ANGELO	5.853.526
1238		CALIFORNIA PUBLIC EMPLOYEES RETIREMENT SYSTEM	CARDARELLI ANGELO	1.588.532
1239		CALIFORNIA PUBLIC EMPLOYEES RETIREMENT SYSTEM	CARDARELLI ANGELO	795.398
1240		CALIFORNIA PUBLIC EMPLOYEES RETIREMENT SYSTEM	CARDARELLI ANGELO	183.986
1241		CALIFORNIA PUBLIC EMPLOYEES RETIREMENT SYSTEM	CARDARELLI ANGELO	26.117
1243		CALIFORNIA STATE TEACHERS RETIREMENT SYSTEM	CARDARELLI ANGELO	110.767
1244		CALIFORNIA STATE TEACHERS RETIREMENT SYSTEM	CARDARELLI ANGELO	1.362.924
1245		CALIFORNIA STATE TEACHERS RETIREMENT SYSTEM	CARDARELLI ANGELO	878.817
1246		CALIFORNIA STATE TEACHERS RETIREMENT SYSTEM	CARDARELLI ANGELO	123.112
1577		CALIFORNIA STATE TEACHERS RETIREMENT SYSTEM	CARDARELLI ANGELO	226.278
1578		CALIFORNIA STATE TEACHERS RETIREMENT SYSTEM	CARDARELLI ANGELO	702.359
1579		CALIFORNIA STATE TEACHERS RETIREMENT SYSTEM	CARDARELLI ANGELO	1.141.130
1580		CALIFORNIA STATE TEACHERS RETIREMENT SYSTEM	CARDARELLI ANGELO	106.484
1581		CALIFORNIA STATE TEACHERS RETIREMENT SYSTEM	CARDARELLI ANGELO	1.030.516
1011		CALVERT VP EAFE INTERNATIONAL INDEX PORTFOLIO	CARDARELLI ANGELO	31.366
2473		CAMGESTION DEEP VALUE	CARDARELLI ANGELO	275.747
1952		CAMPBELL PENSION PLANS MASTER RETIREMENT TRUST	CARDARELLI ANGELO	33.748
72		CANADA LIFE ASSURANCE EUROP LIMITED	CARDARELLI ANGELO	1.902.642
1145		CANADA PENSION PLAN INVESTMENT BOARD	CARDARELLI ANGELO	48.930

ASSEMBLEA ORDINARIA 12 MAGGIO 2016

Segreteria Societaria - Ufficio Titoli



eni

M

81607/1192

Unica convocazione

Esito della votazione sul punto 3

Nomina di un Amministratore ai sensi dell'articolo 2386 del Codice Civile

Elenco Favorevoli

SCHEDA	VPC	NOMINATIVO AZIONISTA	DELEGATO	NUMERO DI AZIONI TOTALE
1146		CANADA PENSION PLAN INVESTMENT BOARD	CARDARELLI ANGELO	3.929.406
512		CANADIAN PACIFIC RAILWAY COMPANY PENSION PLAN	CARDARELLI ANGELO	387.373
228		CANDLES PROVIDENT PENSION FUND	CARDARELLI ANGELO	3.702
3298		CANDRIAM EQUITIES B SA	CARDARELLI ANGELO	30.689
2745		CANDRIAM EQUITIES L	CARDARELLI ANGELO	197.346
2746		CANDRIAM FUND	CARDARELLI ANGELO	40.067
2744		CANDRIAM SRI	CARDARELLI ANGELO	12.496
2851		CAPITAL GROUP ABSOLUTE INCOME GROWER COM	CARDARELLI ANGELO	12.137
3103		CAPITAL GROUP EMPLOYEE BENEFIT INV.TRUST	CARDARELLI ANGELO	15.779
3094		CAPITAL GROUP INTERNATIONAL INC	CARDARELLI ANGELO	5.719
2779		CAPITAL GROWTH FUND ABSOLUTE INCOME GROW	CARDARELLI ANGELO	8.648
2896		CAPITAL INCOME BUILDER INC	CARDARELLI ANGELO	5.436.000
2772		CAPITAL INTERNATIONAL FUND	CARDARELLI ANGELO	171.500
2784		CAPITAL INTERNATIONAL FUND	CARDARELLI ANGELO	125.000
2893		CAPITAL WORLD GROWTH & INCOME FUND INC	CARDARELLI ANGELO	13.395.300
2875		CARBON AWARE INTERNATIONAL SHARES FUND	CARDARELLI ANGELO	22.753
797		CARBP DIVERSIFIE	CARDARELLI ANGELO	55.983
778		CARP - INDO	CARDARELLI ANGELO	146.233
2258		CASSETTE DIVERSIFIE	CARDARELLI ANGELO	65.019
1899		CATERPILLAR INC MASTER RETIREMENT TRUST	CARDARELLI ANGELO	842.418
1900		CATERPILLAR INC. GROUP INSURANCE PLAN TRUST	CARDARELLI ANGELO	46.737
1898		CATERPILLAR INVESTMENT TRUST	CARDARELLI ANGELO	189.262
853		CAVENDISH SYSTEMATIC FUND	CARDARELLI ANGELO	22.333

M

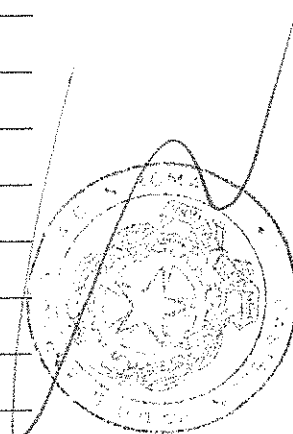

ASSEMBLEA ORDINARIA

81607/1193 12 MAGGIO 2016

Segreteria Societaria - Ufficio Titoli



eni

Unica convocazione

Esito della votazione sul punto 3

Nomina di un Amministratore ai sensi dell'articolo 2386 del Codice Civile

Elenco Favorevoli

SCHEDA	VPC	NOMINATIVO AZIONISTA	DELEGATO	NUMERO DI AZIONI TOTALE
59		CBO SUPERANNUATION CORPORATION PTY LTD	CARDARELLI ANGELO	30.973
648		CC & L INTERNATIONAL EQUITY FUND	CARDARELLI ANGELO	50.100
649		CC&L GLOBAL EQUITY FUND	CARDARELLI ANGELO	188.200
650		CC&L Q GROUP GLOBAL EQUITY FUND	CARDARELLI ANGELO	151.100
318		CCA CORE RETURN FUND	CARDARELLI ANGELO	376
513		CCNPP, INC. MASTER DECOMM TRUSTUNIT ONE QUALIFIED FUND	CARDARELLI ANGELO	10.600
514		CCNPP, INC. MASTER DECOMM TRUSTUNIT ONE QUALIFIED FUND	CARDARELLI ANGELO	12.500
1445		CDN ACWI ALPHA TILTS FUND	CARDARELLI ANGELO	22.753
1984		CENTERPOINT ENERGY, INC. MASTER RETIREMENT TRUST	CARDARELLI ANGELO	34.006
1480		CENTRAL PENSION F OF INT UNION OF OPERAT & PART EMPL	CARDARELLI ANGELO	149.004
997		CENTRAL PROVIDENT FUND BOARD	CARDARELLI ANGELO	22.021
998		CENTRAL PROVIDENT FUND BOARD	CARDARELLI ANGELO	27.900
1010		CERTAS HOME AND AUTO INSURANCE COMPANY	CARDARELLI ANGELO	20.643
311		CF CANLIFE GLOBAL EQUITY INCOMEFUND	CARDARELLI ANGELO	81.134
715		CF INTERNATIONAL STOCK INDEX FUND ONE	CARDARELLI ANGELO	160.658
51		CFSIL - COLONIAL FIRST STATE GLOBAL ASSET MANAGEMENT MULTI SECTOR TRUST 1	CARDARELLI ANGELO	1.036
77		CFSIL RE COLONIAL FIRST STATE INVESTMENT FUND 10	CARDARELLI ANGELO	70.555
892		CGE INVESTMENTS (NO. 2) S.A.R.L.	CARDARELLI ANGELO	41.271
970		CHANG HWA COMM BK AMCO ING CHB GLOBAL HIGH DIVIDEND FUND	CARDARELLI ANGELO	27.232
723		CHAUTAUQUA GLOBAL GROWTH EQUITYQO FUND LP	CARDARELLI ANGELO	11.160
713		CHAUTAUQUA INTERNATIONAL GROWTHEQUITY QP FUND LP	CARDARELLI ANGELO	81.609
2234		CHERRY TREE FUND OF AMERICAN	CARDARELLI ANGELO	186.306
1803		CHESS INTERNATIONAL PROPERTIES, LTD.	CARDARELLI ANGELO	3.172

ASSEMBLEA ORDINARIA 12 MAGGIO 2016

Segreteria Societaria - Ufficio Titoli



eni

Handwritten signature

Unica convocazione

Esito della votazione sul punto 3

Nomina di un Amministratore ai sensi dell'articolo 2386 del Codice Civile

81607/494

Elenco Favorevoli

SCHEDA	VPC	NOMINATIVO AZIONISTA	DELEGATO	NUMERO DI AZIONI TOTALE
1658		CHEVRON MASTER PENSION TRUST	CARDARELLI ANGELO	20.120
1659		CHEVRON MASTER PENSION TRUST	CARDARELLI ANGELO	147.706
1901		CHILDREN'S HEALTHCARE OF ATLANTA, INC.	CARDARELLI ANGELO	87.976
2860		CHINA LIFE INSURANCE (GROUP) COMPANY	CARDARELLI ANGELO	7.186
2859		CHINA LIFE INSURANCE COMPANY LIMITED	CARDARELLI ANGELO	45.565
2862		CHINA LIFE INSURANCE COMPANY LIMITED	CARDARELLI ANGELO	95.760
1267		CHINATRUST CB AMCO FAR EASTERN ALL GLOB MATERIALS & ENERGY F	CARDARELLI ANGELO	23.676
1783		CHRISTIAN SCHOOL PENSION PLAN AND TRUST FUND	CARDARELLI ANGELO	99.375
1489		CHRYSLER LLC MASTER RETIREMENT TRUST	CARDARELLI ANGELO	101.120
45		CHUNGHWA POST CO LTD	CARDARELLI ANGELO	45.795
2953		CHURCH COMMISSIONERS FOR ENGLAND	CARDARELLI ANGELO	13.393
2020		CHURCH OF ENGLAND INVESTMENT FUND FOR PENSIONS	CARDARELLI ANGELO	54.052
707		CIBC EUROPEAN INDEX FUND	CARDARELLI ANGELO	15.103
706		CIBC INTERNATIONAL INDEX FUND	CARDARELLI ANGELO	38.160
708		CIBC POOLED INTERNATIONAL EQUITY INDEX FUND	CARDARELLI ANGELO	36.673
1856		CINDY SPRINGS, LLC	CARDARELLI ANGELO	4.659
1857		CINDY SPRINGS, LLC	CARDARELLI ANGELO	39.959
35		CITIBANK KOREA INC	CARDARELLI ANGELO	1.151.974
741		CITIGROUP PENSION PLAN	CARDARELLI ANGELO	64.356
28		CITITRUST LTD	CARDARELLI ANGELO	120.450
33		CITITRUST LTD	CARDARELLI ANGELO	15.088
428		CITW FUND, LP	CARDARELLI ANGELO	8.378
517		CITY OF CINCINNATI RETIREMENT SYSTEM	CARDARELLI ANGELO	164.096

Handwritten signature

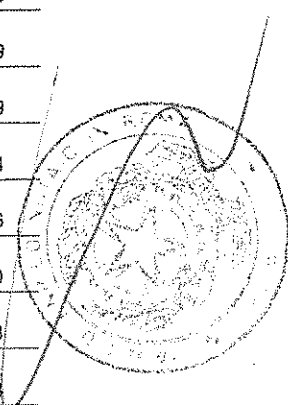

ASSEMBLEA ORDINARIA

81607/1195 12 MAGGIO 2016

Segreteria Societaria - Ufficio Titoli



eni

Unica convocazione

Esito della votazione sul punto 3

Nomina di un Amministratore ai sensi dell'articolo 2386 del Codice Civile

Elenco Favorevoli

SCHEDA	VPC	NOMINATIVO AZIONISTA	DELEGATO	NUMERO DI AZIONI TOTALE
1827		CITY OF CLEARWATER EMPLOYEE'S PENSION FUND CARDARELLI ANGELO		23.900
1520		CITY OF HIALEAH EMPLOYEES' RETIREMENT SYSTEM CARDARELLI ANGELO		25.225
1788		CITY OF LOS ANGELES FIRE AND POLICE PENSION PLAN CARDARELLI ANGELO		1.607.691
1789		CITY OF LOS ANGELES FIRE AND POLICE PENSION PLAN CARDARELLI ANGELO		136.718
1790		CITY OF LOS ANGELES FIRE AND POLICE PENSION PLAN CARDARELLI ANGELO		136.642
1953		CITY OF MILWAUKEE EMPLOYEES RETIREMENT SYSTEM CARDARELLI ANGELO		727.539
626		CITY OF NEW YORK DEFERRED COMPENSATION PLAN CARDARELLI ANGELO		578.174
1151		CITY OF NEW YORK GROUP TRUST CARDARELLI ANGELO		115.683
1152		CITY OF NEW YORK GROUP TRUST CARDARELLI ANGELO		92.224
1153		CITY OF NEW YORK GROUP TRUST CARDARELLI ANGELO		220.236
1576		CITY OF PROVIDENCE EMPLOYEES RETIREMENT SYSTEM CARDARELLI ANGELO		69.607
759		CL EPARGNE DYNAMIQUE CARDARELLI ANGELO		13.248
257		CLAYMORE ZACHS INTERNATIONAL MULTI ASSET INCOME INDEX ETF CARDARELLI ANGELO		5.690
499		CLEVELAND CLINIC HEALTH SYSTEM PENSION TRUST CARDARELLI ANGELO		1.288
3226		CM EUROPE ACTIONS CARDARELLI ANGELO		74.405
507		CN CANADIAN MASTER TRUST FUND CARDARELLI ANGELO		2.722
786		CNP ACP ACTIONS LT CARDARELLI ANGELO		53.023
150		CNP ASSUR VALEURS CARDARELLI ANGELO		17.763
179		CNP ASSURANCES SA CARDARELLI ANGELO		35.261
180		CNP ASSURANCES SA CARDARELLI ANGELO		210.616
181		CNP ASSURANCES SA CARDARELLI ANGELO		4.125.000
182		CNP ASSURANCES SA CARDARELLI ANGELO		533.546
183		CNP ASSURANCES SA CARDARELLI ANGELO		20.678

ASSEMBLEA ORDINARIA 12 MAGGIO 2016

Segreteria Societaria - Ufficio Titoli



M...

Unica convocazione

Esito della votazione sul punto 3

Nomina di un Amministratore ai sensi dell'articolo 2386 del Codice Civile

81607/1196

Elenco Favorevoli

SCHEDA	VPC	NOMINATIVO AZIONISTA	DELEGATO	NUMERO DI AZIONI TOTALE
184	CNP ASSURANCES SA		CARDARELLI ANGELO	1.189.898
185	CNP ASSURANCES SA		CARDARELLI ANGELO	64.000
186	CNP ASSURANCES SA		CARDARELLI ANGELO	52.220
187	CNP ASSURANCES SA		CARDARELLI ANGELO	153.406
188	CNP ASSURANCES SA		CARDARELLI ANGELO	41.755
189	CNP ASSURANCES SA		CARDARELLI ANGELO	4.257.206
190	CNP ASSURANCES SA		CARDARELLI ANGELO	29.155
191	CNP ASSURANCES SA		CARDARELLI ANGELO	736.181
192	CNP ASSURANCES SA		CARDARELLI ANGELO	24.145
193	CNP ASSURANCES SA		CARDARELLI ANGELO	58.945
194	CNP ASSURANCES SA		CARDARELLI ANGELO	8.126
2868	COINVEST LIMITED		CARDARELLI ANGELO	18.565
2494	COLISEE IFC 1 FCP		CARDARELLI ANGELO	200.000
1510	COLLEGE RETIREMENT EQUITIES FUND		CARDARELLI ANGELO	2.339.753
1511	COLLEGE RETIREMENT EQUITIES FUND		CARDARELLI ANGELO	853.353
506	COLLEGES OF APPLIED ARTS AND TECHNOLOGY PENSION P		CARDARELLI ANGELO	328.565
29	COLONIAL FIRST STATE INVESTMENTS LIMITED.		CARDARELLI ANGELO	65.143
30	COLONIAL FIRST STATE INVESTMENTS LIMITED.		CARDARELLI ANGELO	120.326
42	COLONIAL FIRST STATE INVESTMENTS LIMITED.		CARDARELLI ANGELO	449.056
43	COLONIAL FIRST STATE INVESTMENTS LIMITED.		CARDARELLI ANGELO	278.020
27	COLONIAL FIRST STATE INVESTMENTS LTD		CARDARELLI ANGELO	9.259
55	COLONIAL FIRST STATE INVESTMENTS LTD		CARDARELLI ANGELO	61.993
3119	COLUMBIA DIVIDEND OPPORTUNITY FUND		CARDARELLI ANGELO	1.412.620

CNP

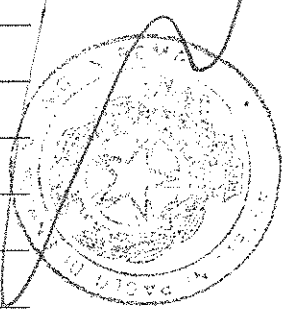

ASSEMBLEA ORDINARIA

81607/497 12 MAGGIO 2016

Segreteria Societaria - Ufficio Titoli



eni

Unica convocazione

Esito della votazione sul punto 3

Nomina di un Amministratore ai sensi dell'articolo 2386 del Codice Civile

Elenco Favorevoli

SCHEDA	VPC	NOMINATIVO AZIONISTA	DELEGATO	NUMERO DI AZIONI TOTALE
3095		COLUMBIA MULTI-ASSET INCOME FUND	CARDARELLI ANGELO	1.623
3118		COLUMBIA VARIABLE PORTF.-DIVIDEND OPPORT	CARDARELLI ANGELO	556.017
994		COMBUSTION ENGINEERING 524(G) ASBESTOS PI TRUST	CARDARELLI ANGELO	9.241
2852		COMMINGLED PENSION FUND ENHANCED INDEX)	CARDARELLI ANGELO	2.617
1603		COMMON TRUST ITALY FUND	CARDARELLI ANGELO	2.357.237
1001		COMMONFUND DIRECT SERIES LLC - CF T. ROWE PRICE EURO EQT SERIE	CARDARELLI ANGELO	93.372
951		COMMONFUND INTERNATIONAL FOCUS FUND I, LLC	CARDARELLI ANGELO	41.909
2044		COMMONWEALTH GLOBAL SHARE FUND 29	CARDARELLI ANGELO	3.093
567		COMMONWEALTH OF PENNSYLVANIA TRAEASURY DEPT.	CARDARELLI ANGELO	26.001
508		COMMONWEALTH OF PENNSYLVANIA PUBLIC SCHOOL EMPLOYEES RETIREMENTENT SYSTEM	CARDARELLI ANGELO	479.687
509		COMMONWEALTH OF PENNSYLVANIA STATE EMPLOYEES RETIREMENT SYSTEM.	CARDARELLI ANGELO	103.982
510		COMMONWEALTH OF PENNSYLVANIA STATE EMPLOYEES RETIREMENT SYSTEM.	CARDARELLI ANGELO	501.546
511		COMMONWEALTH OF PENNSYLVANIA STATE EMPLOYEES RETIREMENT SYSTEM.	CARDARELLI ANGELO	378.712
1890		COMMONWEALTH SUPERANN CORP ATF ARIA INVESTMENTS TR	CARDARELLI ANGELO	209.900
1514		CONAGRA FOODS MASTER PENSION TRUST	CARDARELLI ANGELO	155.381
787		CONCORDE 96	CARDARELLI ANGELO	30.125
2866		CONNECTICUT GENERAL LIFE INSURANCE COMPA	CARDARELLI ANGELO	29.305
2867		CONNECTICUT GENERAL LIFE INSURANCE COMPA	CARDARELLI ANGELO	30.800
1440		CONNECTICUT GENERAL LIFE INSURANCE COMPANY	CARDARELLI ANGELO	11.208
1553		CONSOLIDATED EDISON RETIREMENT PLAN	CARDARELLI ANGELO	300.950
2835		CONSTRUCTION AND BUILDING UNIONS SUPERAN	CARDARELLI ANGELO	66.300
2472		CONTI FLEXIBLE	CARDARELLI ANGELO	26.919
1154		COSMOPOLITAN INVESTMENT FUND	CARDARELLI ANGELO	26.145

ASSEMBLEA ORDINARIA

12 MAGGIO 2016

Segreteria Societaria - Ufficio Titoli



Murphy

Unica convocazione

Esito della votazione sul punto 3

Nomina di un Amministratore ai sensi dell'articolo 2386 del Codice Civile

81607/198

Elenco Favorevoli

SCHEDA	VPC	NOMINATIVO AZIONISTA	DELEGATO	NUMERO DI AZIONI TOTALE
1155		COSMOPOLITAN INVESTMENT FUND	CARDARELLI ANGELO	4.553
1157		COSMOPOLITAN INVESTMENT FUND	CARDARELLI ANGELO	60.256
1158		COSMOPOLITAN INVESTMENT FUND	CARDARELLI ANGELO	3.371
492		COUNTY AND MUNICIPAL GOVT CAPITAL IMPROVEMENT TRUST FUND	CARDARELLI ANGELO	29.400
530		COUNTY EMPLOYEES ANNUITY AND BENEFIT FUND OF COOK COUNTY	CARDARELLI ANGELO	98.997
581		COUNTY OF LOS ANGELES SAVINGS PLAND THRIFT PLAN	CARDARELLI ANGELO	56.744
852		CPPIB MAP CAYMAN SPC. ON BEHALF OF AND FOR THE ACCOUNT OF SEGREGATED PORTFOLIO D.	CARDARELLI ANGELO	46.756
3208		CPR AM	CARDARELLI ANGELO	374.770
151		CPR EUROLAND	CARDARELLI ANGELO	523.441
147		CROISSANCE DIVERSIFIE	CARDARELLI ANGELO	2.653
1753		CSAA INSURANCE EXCHANGE	CARDARELLI ANGELO	171.516
1754		CULTURAL INSTITUTIONS PENSION PLAN TRUST	CARDARELLI ANGELO	19.936
1955		CUMMINS INC. AND AFFILIATES COLLECTIVE INVESTMENT TRUST	CARDARELLI ANGELO	60.345
3200		D.E SHAW COUNTRY GLOBAL ALPHA EXTENSION PORTFOLIOS LLC	CARDARELLI ANGELO	1.849
2260		DARWIN DIVERSIFIE 60-80 ACTION	CARDARELLI ANGELO	13.805
2261		DARWIN DIVERSIFIE 80-100 ACT	CARDARELLI ANGELO	41.394
524		DAUGHTERS OF CHARITY OF ST VINCENT DE PAUL PROVINCE OF THE WEST	CARDARELLI ANGELO	72.656
335		DB X TRACKERS MSCI EUROPE EQUITY	CARDARELLI ANGELO	1.096.332
2593		DBI FONDS EKIBB	CARDARELLI ANGELO	24.140
3199		DE SHAW VALUE ALL COUNTRY ALPHA EXTENSION FUND	CARDARELLI ANGELO	114.231
3217		DEAM FONDS ROCK	CARDARELLI ANGELO	88.088
3243		DEAM FONDS VVK 2	CARDARELLI ANGELO	7.540
389		DEAM-FONDS DCG EQ DEAM-FONDS DCG EQ	CARDARELLI ANGELO	21.894

3

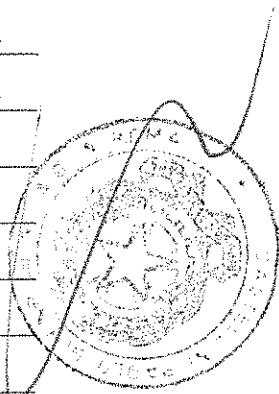

ASSEMBLEA ORDINARIA

81607/1099 12 MAGGIO 2016

Segreteria Societaria - Ufficio Titoli



eni

Unica convocazione

Esito della votazione sul punto 3

Nomina di un Amministratore ai sensi dell'articolo 2386 del Codice Civile

Elenco Favorevoli

SCHEDA	VPC	NOMINATIVO AZIONISTA	DELEGATO	NUMERO DI AZIONI TOTALE
387		DEAM-FONDS MMM SPEZIAL .	CARDARELLI ANGELO	42.609
1401		DEAWM FOR OPPENHEIM DYNAMIC EUROPE BALANCE	CARDARELLI ANGELO	43.161
1184		DEAWM INV GMBH FOR DEAM-FONDS CPT	CARDARELLI ANGELO	17.500
1404		DEAWM INV GMBH FOR DEUTSCHE QUANT EQUITY EUROPE	CARDARELLI ANGELO	28.268
1396		DEAWM INVESTMENT GMBH FOR ALBATROS FONDS OP	CARDARELLI ANGELO	13.592
1185		DEAWM INVESTMENT GMBH FOR DEAWM-FONDS HED	CARDARELLI ANGELO	12.000
1186		DEAWM INVESTMENT GMBH FOR DEAWM-FONDS HED	CARDARELLI ANGELO	11.500
1395		DEAWM INVESTMENT GMBH FOR VERMOEGENSMANAGEMENT RENDITE OP	CARDARELLI ANGELO	108.025
2734		DEFINED BENEFIT PP FOR CHUGOKU ELECT	CARDARELLI ANGELO	14.548
2353		DEGROOF EQ. EMU HIGH DY	CARDARELLI ANGELO	290.000
2806		DEKA BASISSTRATEGIE FLEXIBEL	CARDARELLI ANGELO	6.800
3012		DEKA FUND INVESTMENT RE/ A-HORCH-FONDS	CARDARELLI ANGELO	173.100
2992		DEKA FUNDMASTER INVESTMENTGESELLSCHAFT M	CARDARELLI ANGELO	2.940
3049		DEKA INTERNATIONAL S.A RE DEKALUX-EUROPA	CARDARELLI ANGELO	175.000
3056		DEKA INTERNATIONAL S.A. RE DEKA PRIVATE	CARDARELLI ANGELO	2.400
3054		DEKA INTERNATIONAL S.A. RE DEKA-EUROPAVA	CARDARELLI ANGELO	45.670
3055		DEKA INTERNATIONAL S.A. RE DEKA-EUROSTOC	CARDARELLI ANGELO	360.000
3057		DEKA INTERNATIONAL S.A. RE DEKALUX-GLOBA	CARDARELLI ANGELO	122.908
2986		DEKA INTL S.A GLOBALE AKTIEN LOWRISK	CARDARELLI ANGELO	14.770
3005		DEKA INV. GMBH RE A-GOLDENE AUE-FONDS	CARDARELLI ANGELO	40.000
3004		DEKA INV. GMBH RE BAUTZEN FUNDMASTER	CARDARELLI ANGELO	62.300
3001		DEKA INV. RE A-STENDALER-ROLANDFONDS I	CARDARELLI ANGELO	15.000
2807		DEKA INVEST DEKA EURO STOXX 50 - UCITS	CARDARELLI ANGELO	14.638

ASSEMBLEA ORDINARIA 12 MAGGIO 2016

Segreteria Societaria - Ufficio Titoli



Handwritten signature

Unica convocazione

Esito della votazione sul punto 3

Nomina di un Amministratore ai sensi dell'articolo 2386 del Codice Civile

81607/1200

Elenco Favorevoli

SCHEDA VPC	NOMINATIVO AZIONISTA	DELEGATO	NUMERO DI AZIONI TOTALE
2826	DEKA INVEST DEKA EURO STOXX 50 - UCITS	CARDARELLI ANGELO	1.252.675
2824	DEKA INVEST DIVIDENDENSTRATEGIE CF A	CARDARELLI ANGELO	908.400
2995	DEKA INVEST GMBH RE A-MUEHLEN FONDS	CARDARELLI ANGELO	40.000
2989	DEKA INVEST GMBH RE A-VSA-FONDS	CARDARELLI ANGELO	41.332
3006	DEKA INVEST GMBH RE AGR DENA I	CARDARELLI ANGELO	8.590
3021	DEKA INVEST GMBH RE BODENSEE-FONDS	CARDARELLI ANGELO	1.300
2812	DEKA INVEST GMBH RE DEKA-BAV-FONDS	CARDARELLI ANGELO	49.050
2816	DEKA INVEST GMBH RE DEKA-BR 85	CARDARELLI ANGELO	61.205
2822	DEKA INVEST GMBH RE DEKA-PB DEFENSIV	CARDARELLI ANGELO	7.903
3008	DEKA INVEST GMBH RE PRHL 1-FONDS	CARDARELLI ANGELO	16.000
2828	DEKA INVEST GMBH RE STOXX EUROPE 50 ETF	CARDARELLI ANGELO	23.694
2997	DEKA INVEST GMBH re SPKED 01 FONDS	CARDARELLI ANGELO	20.300
3018	DEKA INVEST MAULBRONN-STROMBERG-FONDS	CARDARELLI ANGELO	18.950
2993	DEKA INVEST RE A-CRISPINUS FOND	CARDARELLI ANGELO	5.000
2821	DEKA INVEST RE DEKA-EUROLAND BALANCE	CARDARELLI ANGELO	1.104.300
3009	DEKA INVEST RE DEKA-ZMV-FONDS	CARDARELLI ANGELO	9.100
3017	DEKA INVEST RE KOMMUNAL-TUT-BALANCED -FO	CARDARELLI ANGELO	17.050
2813	DEKA INVEST RE MEGATRENDS CF	CARDARELLI ANGELO	47.000
2814	DEKA INVEST RE SIGMA PLUS KONSERVATIV	CARDARELLI ANGELO	11.074
2990	DEKA INVEST RE VSINVESTMENT GOCH-FONDS	CARDARELLI ANGELO	80.000
2829	DEKA INVEST RE/DEKA-GLOBAL CHAMPIONS	CARDARELLI ANGELO	75.000
3010	DEKA INVEST REGIONALE-WUPPERTAL-FONDS	CARDARELLI ANGELO	6.822
3016	DEKA INVEST. GMBH RE A-KLB-MASTERFONDS	CARDARELLI ANGELO	366.000

Handwritten signature

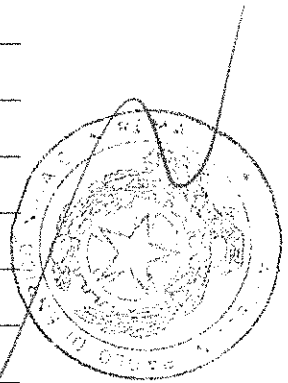

ASSEMBLEA ORDINARIA

81607/1201 12 MAGGIO 2016

Segreteria Societaria - Ufficio Titoli



Unica convocazione

Esito della votazione sul punto 3

Nomina di un Amministratore ai sensi dell'articolo 2386 del Codice Civile

Elenco Favorevoli

SCHEDA	VPC	NOMINATIVO AZIONISTA	DELEGATO	NUMERO DI AZIONI TOTALE
2811		DEKA INVEST. RE DEKA-DIVIDENDDISCOUNT	CARDARELLI ANGELO	9.100
2998		DEKA INVEST.GMBH RE A-HAM-FONDS	CARDARELLI ANGELO	16.400
3000		DEKA INVEST.GMBH RE SVN II FONDS	CARDARELLI ANGELO	7.338
2825		DEKA INVESTGMBH RE MSCI EUROPE LC UCITS	CARDARELLI ANGELO	13.466
2991		DEKA INVESTMENT A-WITTRING MASTER FONDS	CARDARELLI ANGELO	3.150
2827		DEKA INVESTMENT GMBH DEKA MSCI EUROPE UC	CARDARELLI ANGELO	73.681
917		DEKA INVESTMENT GMBH FOR FTS-FONDS	CARDARELLI ANGELO	66.499
1022		DEKA INVESTMENT GMBH FOR VEW-FONDS	CARDARELLI ANGELO	11.017
3023		DEKA INVESTMENT GMBH RE A-AMISIA-FONDS	CARDARELLI ANGELO	27.000
3024		DEKA INVESTMENT GMBH RE A-ASD FONDS	CARDARELLI ANGELO	9.900
3003		DEKA INVESTMENT GMBH RE A-KSK FULDA-FOND	CARDARELLI ANGELO	10.500
3026		DEKA INVESTMENT GMBH RE A-SKGO-FONDS	CARDARELLI ANGELO	7.500
2999		DEKA INVESTMENT GMBH RE BRODO INVEST	CARDARELLI ANGELO	5.148
3048		DEKA INVESTMENT GMBH RE DEKA EURO ISTOXX	CARDARELLI ANGELO	281.885
2805		DEKA INVESTMENT GMBH RE DEKA-BASIS	CARDARELLI ANGELO	10.000
2815		DEKA INVESTMENT GMBH RE DEKA-BR 100	CARDARELLI ANGELO	301.806
3020		DEKA INVESTMENT GMBH RE DEKA-BR 20	CARDARELLI ANGELO	3.539
2819		DEKA INVESTMENT GMBH RE DEKA-BR 35	CARDARELLI ANGELO	17.855
2818		DEKA INVESTMENT GMBH RE DEKA-BR 55	CARDARELLI ANGELO	8.171
2817		DEKA INVESTMENT GMBH RE DEKA-BR 75	CARDARELLI ANGELO	37.884
2808		DEKA INVESTMENT GMBH RE DEKA-DIVIDEND VA	CARDARELLI ANGELO	75.800
2820		DEKA INVESTMENT GMBH RE DEKAFUTUR-CHANCE	CARDARELLI ANGELO	17.000
2809		DEKA INVESTMENT GMBH RE DEKASPEZIAL	CARDARELLI ANGELO	90.351

ASSEMBLEA ORDINARIA 12 MAGGIO 2016

Segreteria Societaria - Ufficio Titoli



eni

Unica convocazione

Esito della votazione sul punto 3

Nomina di un Amministratore ai sensi dell'articolo 2386 del Codice Civile

81607/1202

M. M.

Elenco Favorevoli

SCHEDA	VPC	NOMINATIVO AZIONISTA	DELEGATO	NUMERO DI AZIONI TOTALE
3025		DEKA INVESTMENT GMBH RE LANDSBERG-FONDS	CARDARELLI ANGELO	11.600
2994		DEKA INVESTMENT GMBH RE PFRUENDE INVEST	CARDARELLI ANGELO	6.450
3007		DEKA INVESTMENT GMBH RE PRODEKA	CARDARELLI ANGELO	178.000
3013		DEKA INVESTMENT GMBH RE SAPHIR-FONDS	CARDARELLI ANGELO	11.000
3011		DEKA INVESTMENT GMBH RE STADTBAHN-FONDS	CARDARELLI ANGELO	5.033
2987		DEKA INVESTMENT GMBH RE SVN-FONDS	CARDARELLI ANGELO	6.350
3002		DEKA INVESTMENT GMBH RE WESPA-MASTERFOND	CARDARELLI ANGELO	63.025
3015		DEKA INVESTMENT MBH RE PKBMF	CARDARELLI ANGELO	21.350
3014		DEKA INVESTMENTMBH RE DONAU-FUNDMASTER	CARDARELLI ANGELO	40.000
2540		DEKA MASTER HAEK I	CARDARELLI ANGELO	65.873
2541		DEKA MASTER HAEK I	CARDARELLI ANGELO	139.182
3050		DEKA NACHHALTIGKEIT BALANCE CF (A)	CARDARELLI ANGELO	45.000
735		DELAWARE GROUP FOUNDATION FUNDSDELAWARE FOUNDATION GROWTH ALLOCATION FUNDS	CARDARELLI ANGELO	525.208
1012		DELUXE CORPORATION MASTER TRUST	CARDARELLI ANGELO	46.331
526		DENVER EMPLOYEES RETIREMENT PLAN	CARDARELLI ANGELO	77.672
1005		DESJARDINS ASSURANCES GENERALES INC.	CARDARELLI ANGELO	10.124
1002		DESJARDINS DIVIDEND INCOME FUND	CARDARELLI ANGELO	37.600
1009		DESJARDINS IBRIX GLOBAL EQUITY FOCUS FUND	CARDARELLI ANGELO	953
1003		DESJARDINS SECURITE FINANCIERE COMPAGNIE D'ASSURANCE VIE	CARDARELLI ANGELO	8.159
1004		DESJARDINS SECURITE FINANCIERE COMPAGNIE D'ASSURANCE VIE	CARDARELLI ANGELO	21.073
1008		DESJARDINS SECURITE FINANCIERE COMPAGNIE D'ASSURANCE VIE	CARDARELLI ANGELO	6.105
1162		DEUT ASS & WEALTH MNGM INV GMBH FOR DEAM CAP PROTECT AKTIEN	CARDARELLI ANGELO	239
1168		DEUT ASS & WEALTH MNGM INV GMBH FOR DEAM-FONDS AKTIEN-BM-F I	CARDARELLI ANGELO	35.000

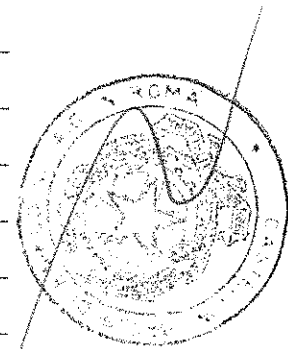

ASSEMBLEA ORDINARIA

81607/1203 12 MAGGIO 2016

Segreteria Societaria - Ufficio Titoli



eni

Unica convocazione

Esito della votazione sul punto 3

Nomina di un Amministratore ai sensi dell'articolo 2386 del Codice Civile

Elenco Favorevoli

SCHEDA	VPC	NOMINATIVO AZIONISTA	DELEGATO	NUMERO DI AZIONI TOTALE
1177		DEUT ASS & WEALTH MNGM INV GMBH FOR DEAM-FONDS AVD 2	CARDARELLI ANGELO	6.985
1171		DEUT ASS & WEALTH MNGM INV GMBH FOR DEAM-FONDS BBR 1	CARDARELLI ANGELO	43.200
952		DEUT ASS & WEALTH MNGM INV GMBH FOR DEAM-FONDS BBS	CARDARELLI ANGELO	15.900
1176		DEUT ASS & WEALTH MNGM INV GMBH FOR DEAM-FONDS BG 2	CARDARELLI ANGELO	8.000
1183		DEUT ASS & WEALTH MNGM INV GMBH FOR DEAM-FONDS BPT	CARDARELLI ANGELO	209.527
1257		DEUT ASS & WEALTH MNGM INV GMBH FOR DEAM-FONDS BPT	CARDARELLI ANGELO	7.000
1170		DEUT ASS & WEALTH MNGM INV GMBH FOR DEAM-FONDS BW GERMANY	CARDARELLI ANGELO	9.700
1172		DEUT ASS & WEALTH MNGM INV GMBH FOR DEAM-FONDS ENPT	CARDARELLI ANGELO	27.400
1178		DEUT ASS & WEALTH MNGM INV GMBH FOR DEAM-FONDS FBK 1	CARDARELLI ANGELO	8.000
1165		DEUT ASS & WEALTH MNGM INV GMBH FOR DEAM-FONDS FES	CARDARELLI ANGELO	25.000
1254		DEUT ASS & WEALTH MNGM INV GMBH FOR DEAM-FONDS GHS	CARDARELLI ANGELO	50.000
1265		DEUT ASS & WEALTH MNGM INV GMBH FOR DEAM-FONDS GSK 1	CARDARELLI ANGELO	25.500
1181		DEUT ASS & WEALTH MNGM INV GMBH FOR DEAM-FONDS NRRR	CARDARELLI ANGELO	6.800
1264		DEUT ASS & WEALTH MNGM INV GMBH FOR DEAM-FONDS PAL 1	CARDARELLI ANGELO	19.300
1252		DEUT ASS & WEALTH MNGM INV GMBH FOR DEAM-FONDS PG EQ	CARDARELLI ANGELO	99.278
1180		DEUT ASS & WEALTH MNGM INV GMBH FOR DEAM-FONDS PKN 2	CARDARELLI ANGELO	11.700
1253		DEUT ASS & WEALTH MNGM INV GMBH FOR DEAM-FONDS PKN 2	CARDARELLI ANGELO	13.696
1173		DEUT ASS & WEALTH MNGM INV GMBH FOR DEAM-FONDS PPC EQ	CARDARELLI ANGELO	56.171
1166		DEUT ASS & WEALTH MNGM INV GMBH FOR DEAM-FONDS PPC GEQ	CARDARELLI ANGELO	14.629
1169		DEUT ASS & WEALTH MNGM INV GMBH FOR DEAM-FONDS RLG GERMANY	CARDARELLI ANGELO	34.900
1400		DEUT ASS & WEALTH MNGM INV GMBH FOR DWS GLB NAT RES EQ TYP O	CARDARELLI ANGELO	59.297
1397		DEUT ASS & WEALTH MNGM INV GMBH FOR DWS VORSORGE AS (DYNAMIK)	CARDARELLI ANGELO	107.499
1399		DEUT ASS & WEALTH MNGM INV GMBH FOR DWS VORSORGE AS (FLEX)	CARDARELLI ANGELO	44.970

ASSEMBLEA ORDINARIA

12 MAGGIO 2016

Segreteria Societaria - Ufficio Titoli



Maner

Unica convocazione

Esito della votazione sul punto 3

Nomina di un Amministratore ai sensi dell'articolo 2386 del Codice Civile

81607/1206

Elenco Favorevoli

SCHEDA	VPC	NOMINATIVO AZIONISTA	DELEGATO	NUMERO DI AZIONI TOTALE
1174		DEUT ASS & WEALTH MNGM INV GMBH FOR GCB PENSION FUND GERMANY	CARDARELLI ANGELO	10.886
1398		DEUT ASS & WEALTH MNGM INV GMBH FOR LOWEN-AKTIEFONDS	CARDARELLI ANGELO	15.000
1402		DEUT ASS & WEALTH MNGM INV GMBH FOR OPPENHEIM GLOBAL STRATEGIE	CARDARELLI ANGELO	9.309
1403		DEUT ASS & WEALTH MNGM INV GMBH FOR SOP EUROLANDWERTE	CARDARELLI ANGELO	65.329
1182		DEUT ASS & WEALTH MNGM INV GMBH FOR STIFTUNGSFONDS SVC 1	CARDARELLI ANGELO	10.268
1406		DEUTSCHE A AND W MANAGEMENT INVESTMENT S.A. FOR DWS ETOILE	CARDARELLI ANGELO	7.500
1175		DEUTSCHE ASSET AND WEALTH MNGM INV GMBH FOR OP-FONDS WFF	CARDARELLI ANGELO	5.173
1179		DEUTSCHE ASSET AND WEALTH MNGM INV GMBH FOR OP-FONDS WFF	CARDARELLI ANGELO	6.471
1405		DEUTSCHE AT AND W MGMT INVEST GMBH FOR MULTI INDEX EQT FD	CARDARELLI ANGELO	14.594
1141		DEUTSCHE BANK-ONSHORE	CARDARELLI ANGELO	6.603
1100		DEUTSCHE EAFE EQUITY INDEX FUND	CARDARELLI ANGELO	11.259
410		DEUTSCHE X-TRACKERS FTSE DEVELOPED EX US COMPREHENSIVE FACTOR ETF	CARDARELLI ANGELO	73
337		DEUTSCHE X-TRACKERS MSCI ALL WORLD EX US HEDGED EQUITY ETF	CARDARELLI ANGELO	10.406
296		DEUTSCHE X-TRACKERS MSCI EAFE HEDGE EQUITY ETF	CARDARELLI ANGELO	2.499.106
363		DEUTSCHE X-TRACKERS MSCI EMU HEDGED EQUITY ETF	CARDARELLI ANGELO	50.110
404		DEUTSCHE X-TRACKERS MSCI ITALY HEDGED EQUITY ETF	CARDARELLI ANGELO	17.213
393		DEUTSCHE X-TRACKERS MSCI SOUTHERN EUROPE HEDGED EQUITY ETF	CARDARELLI ANGELO	7.673
3297		DEXIA PENSION FUND DEXIA ASSET MANAGEMEN	CARDARELLI ANGELO	56.073
1508		DIGNITY HEALTH	CARDARELLI ANGELO	59.547
1509		DIGNITY HEALTH RETIREMENT PLAN TRUST	CARDARELLI ANGELO	56.697
2509		DILL COFONDS	CARDARELLI ANGELO	26.000
529		DIOCESE OF VENICE PENSION PLAN & TRUST	CARDARELLI ANGELO	7.092
2263		DIVERSIFIE ACTIONS 50-65 DU CD	CARDARELLI ANGELO	3.916

Maner

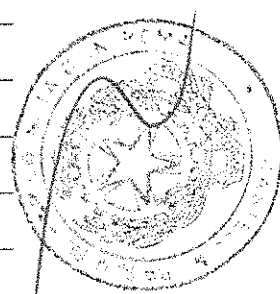

ASSEMBLEA ORDINARIA

81607/2015 12 MAGGIO 2016

Segreteria Societaria - Ufficio Titoli



eni

Unica convocazione

Esito della votazione sul punto 3

Nomina di un Amministratore ai sensi dell'articolo 2386 del Codice Civile

Elenco Favorevoli

SCHEDA	VPC	NOMINATIVO AZIONISTA	DELEGATO	NUMERO DI AZIONI TOTALE
1492		DIVERSIFIED INVESTORS PORTFOLIO - INTERNATIONAL EQUITY PTF	CARDARELLI ANGELO	324.215
1303		DIVERSIFIED MARKETS (2010) POOLED FUND TRUST	CARDARELLI ANGELO	22.195
1806		DODDINGTON GLOBAL FUND LLC	CARDARELLI ANGELO	392.795
1902		DOMINION RESOURCES INC. MASTER TRUST	CARDARELLI ANGELO	49.000
525		DOMTAR INDUSTRIES INC. MASTER TRUST	CARDARELLI ANGELO	25.000
2996		DPBDIM-Fonds	CARDARELLI ANGELO	9.000
364		DREYFUS INDEX FUNDS INC DREYFUS INTERNATIONAL STC	CARDARELLI ANGELO	114.542
716		DT INTERNATIONAL STOCK INDEX FUND ONE	CARDARELLI ANGELO	168.289
1784		DUKE ENERGY CORPORATION MASTER RETIREMENT TRUST	CARDARELLI ANGELO	82.180
674		DUKE UNIVERSITY	CARDARELLI ANGELO	73.458
1099		DWS GLOBAL INCOME BUILDER VIP	CARDARELLI ANGELO	234
1840		DYNASTY INVEST, LTD	CARDARELLI ANGELO	3.682
3022		Deka A-Altenburg-Fonds	CARDARELLI ANGELO	5.000
2988		Deka A-DIM-Wetzlar-Fonds	CARDARELLI ANGELO	8.350
1958		EAST BAY MUNICIPAL UTILITY DISTRICT	CARDARELLI ANGELO	82.823
1698		EAST RIDING PENSION FUND	CARDARELLI ANGELO	120.000
1699		EAST RIDING PENSION FUND	CARDARELLI ANGELO	205.949
1033		EATON VANCE RICHARD BERNSTEIN ALL ASSET STRATEGY FUND	CARDARELLI ANGELO	77.370
1040		EATON VANCE RICHARD BERNSTEIN EQT STRATEGY FUND	CARDARELLI ANGELO	243.341
149		ECUREUIL ENERGIE	CARDARELLI ANGELO	177.570
2064		EDINBURGH PARTNERS OPPORTUNITIES FUND PLC	CARDARELLI ANGELO	471.558
2065		EDINBURGH PARTNERS OPPORTUNITIES FUND PLC	CARDARELLI ANGELO	338.732
129		EDMOND DE ROTHSCHILD ASSET MANAGEMENT	CARDARELLI ANGELO	400.000

ASSEMBLEA ORDINARIA 12 MAGGIO 2016

Segreteria Societaria - Ufficio Titoli



Murelli

Unica convocazione

Esito della votazione sul punto 3

Nomina di un Amministratore ai sensi dell'articolo 2386 del Codice Civile

81607/1206

Elenco Favorevoli

SCHEDA	VPC	NOMINATIVO AZIONISTA	DELEGATO	NUMERO DI AZIONI TOTALE
203		EDMOND DE ROTHSCHILD ASSET MANAGEMENT	CARDARELLI ANGELO	100.000
544		ELECTRICAL WORKERS LOCAL 26 PENSION TRUST FUND	CARDARELLI ANGELO	91.700
413		ELECTRICITY SUPPLY PENSION SCHEME	CARDARELLI ANGELO	39.976
769		ELITE INTER-PHARMACOINS	CARDARELLI ANGELO	46.206
1956		EMPLOYEES RETIREMENT FUND OF THE CITY OF DALLAS	CARDARELLI ANGELO	4.148
678		EMPLOYEES RETIREMENT SYSTEM OF TEXAS	CARDARELLI ANGELO	370.503
561		EMPLOYEES RETIREMENT SYSTEM OF THE STATE OH HAWAII	CARDARELLI ANGELO	313.537
968		ENERGY INSURANCE MUTUAL LIMITED	CARDARELLI ANGELO	17.445
969		ENERGY INSURANCE MUTUAL LIMITED	CARDARELLI ANGELO	16.932
2630		ENHANCED INDEX INTERNATIONAL SHARE FUND	CARDARELLI ANGELO	343.066
2631		ENHANCED INDEX INTERNATIONAL SHARE FUND	CARDARELLI ANGELO	119.251
2636		ENHANCED INDEX INTERNATIONAL SHARE FUND	CARDARELLI ANGELO	202.562
3093		ENTERGY CORP. RETIREMENT PLANS MASTER TR.	CARDARELLI ANGELO	142.968
755		EPARGNE EQUILIBRE FCPE	CARDARELLI ANGELO	11.749
756		EPARGNE PRUDENCE THALES	CARDARELLI ANGELO	27.289
3121		EQ ADV TRUST EQ/INT. EQ. INDEX PORTFOLIO	CARDARELLI ANGELO	717.254
3108		EQ ADVISOR TRUST ATM INTERNATIONAL PORTFOLIO	CARDARELLI ANGELO	227.830
3100		EQ ADVISORS TRUST - AXA INTERNATIONAL CORE MANAGED VOLATILITY PORTFOLIO	CARDARELLI ANGELO	174.869
3109		EQ ADVISORS TRUST - AXA INTERNATIONAL MANAGED VOLATILITY PORTFOLIO	CARDARELLI ANGELO	94.414
2874		EQ ADVISORS TRUST-AXA GLOBAL EQ MANAGED	CARDARELLI ANGELO	135.204
2888		EQ ADVISORS TRUST-AXA INTL. VALUE MANAGED	CARDARELLI ANGELO	277.410
3110		EQ ADVISORS TRUST-AXA TACTICAL MANAGER I	CARDARELLI ANGELO	351.566
3117		EQ ALLIANCE DYNAMIC WEALTH STRATEGIES PO	CARDARELLI ANGELO	77.905

Murelli

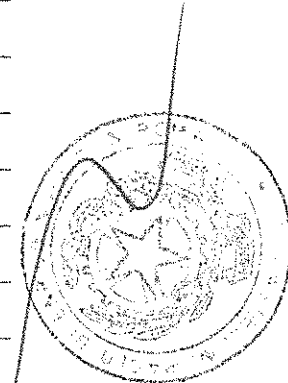

ASSEMBLEA ORDINARIA

81607/1207 12 MAGGIO 2016

Segreteria Societaria - Ufficio Titoli



eni

Unica convocazione

Esito della votazione sul punto 3

Nomina di un Amministratore ai sensi dell'articolo 2386 del Codice Civile

Elenco Favorevoli

SCHEDA	VPC	NOMINATIVO AZIONISTA	DELEGATO	NUMERO DI AZIONI TOTALE
3104		EQ.ADVISORS TRUST - AXA TEMPLETON GLOBAL	CARDARELLI ANGELO	170.086
3106		EQ.ADVISORS TRUST - AXA TEMPLETON GLOBAL	CARDARELLI ANGELO	31.767
3098		EQ/NATURAL RESOURCES PLUS PORTFOLIO	CARDARELLI ANGELO	23.445
541		EQUITY LEAGUE PENSION TRUST FUND	CARDARELLI ANGELO	128.584
406		ERIE INSURANCE EXCHANGE .	CARDARELLI ANGELO	113.374
1757		ERIKA GLAZER	CARDARELLI ANGELO	11.200
3133		ETF5 DIVERSIFIED-FACTOR DEVELOPED EUROPE INDEX FUND	CARDARELLI ANGELO	69
2459		ETHIS VALEURS	CARDARELLI ANGELO	34.410
2277		ETOILE DEVELOPPEMENT DURABLE	CARDARELLI ANGELO	7.424
2264		ETOILE ENERGIE EUROPE	CARDARELLI ANGELO	10.546
2279		ETOILE GESTION	CARDARELLI ANGELO	37.564
2276		ETOILE MATIERES PREMIERES	CARDARELLI ANGELO	13.656
1459		EURO EX-UK ALPHA TITLS FUND B	CARDARELLI ANGELO	100.458
2882		EUROPACIFIC GROWTH FUND	CARDARELLI ANGELO	2.843.000
2409		EUROPEAN EQUITY FUND OF KOKUSAI TRUST INTERTRUST TRUSTEES	CARDARELLI ANGELO	60.136
3166		EUROPEAN STRATEGIC BALANCED FUND	CARDARELLI ANGELO	5.300
1469		EUROPEEX-CONTROVERSIAL WEAPONS EQUITY INDEX FUND B	CARDARELLI ANGELO	475.041
533		EVANGELICAL LUTHERAN CHURCH IN AMERICA BOARD OF PENSIONS	CARDARELLI ANGELO	59.148
534		EVANGELICAL LUTHERAN CHURCH IN AMERICA BOARD OF PENSIONS	CARDARELLI ANGELO	52.633
536		EVANGELICAL LUTHERAN CHURCH IN AMERICA BOARD OF PENSIONS	CARDARELLI ANGELO	387.110
537		EVANGELICAL LUTHERAN CHURCH IN AMERICA BOARD OF PENSIONS	CARDARELLI ANGELO	18.010
538		EVANGELICAL LUTHERAN CHURCH IN AMERICA BOARD OF PENSIONS	CARDARELLI ANGELO	29.238
539		EVANGELICAL LUTHERAN CHURCH IN AMERICA BOARD OF PENSIONS	CARDARELLI ANGELO	194.092

ASSEMBLEA ORDINARIA 12 MAGGIO 2016

Segreteria Societaria - Ufficio Titoli



Manu

Unica convocazione

Esito della votazione sul punto 3

Nomina di un Amministratore ai sensi dell'articolo 2386 del Codice Civile

81607/1208

Elenco Favorevoli

SCHEDA	VPC	NOMINATIVO AZIONISTA	DELEGATO	NUMERO DI AZIONI TOTALE
540		EVANGELICAL LUTHERAN CHURCH IN AMERICA BOARD OF PENSIONS	CARDARELLI ANGELO	21.562
81		EVERKEY GLOBAL FOCUS MASTER LIMITED CO WELLS CAPITAL MGM INC.	CARDARELLI ANGELO	13.858
758		EVIAN A EQUILIBRE	CARDARELLI ANGELO	6.413
744		EVOLUTIS	CARDARELLI ANGELO	296.955
1903		EXELON CORPORATION DEF CONTRIBUTION RET PLANS MASTER TR	CARDARELLI ANGELO	57.196
1904		EXELON CORPORATION DEF CONTRIBUTION RET PLANS MASTER TR	CARDARELLI ANGELO	115.658
1778		EXELON CORPORATION EMPLOYEES BENEFIT TRUST FOR MNG EMPL	CARDARELLI ANGELO	28.850
1779		EXELON CORPORATION NUCLEAR DECOMMISSION TRUST - NON TAX QUAL	CARDARELLI ANGELO	1.672
1945		EXELON CORPORATION PENSION MASTER RETIREMENT TRUST	CARDARELLI ANGELO	343.299
1946		EXELON CORPORATION PENSION MASTER RETIREMENT TRUST	CARDARELLI ANGELO	128.350
1756		EXELON PEACH BOTTOM UNIT 1 QUALIFIED FUND	CARDARELLI ANGELO	2.069
2710		FAMEM F	CARDARELLI ANGELO	1.889
1679		FAMILY INVESTMENTS CHILD TRUST FUND	CARDARELLI ANGELO	66.038
1680		FAMILY INVESTMENTS GLOBAL ICVC FAMILY BALANCED INT FUND	CARDARELLI ANGELO	64.414
545		FARMERS GROUP INC.401K SAVINGS PLAN	CARDARELLI ANGELO	200.847
785		FC CARPIMKO	CARDARELLI ANGELO	52.213
1862		FCM INTERNATIONAL LLC	CARDARELLI ANGELO	4.068
2703		FCO THELIA	CARDARELLI ANGELO	1.483
2712		FCP 6347	CARDARELLI ANGELO	3.014
794		FCP ABP PERP	CARDARELLI ANGELO	32.863
2453		FCP ACTIONS ISR	CARDARELLI ANGELO	1.544.249
2454		FCP AG2R LA MONDIALE ACT EUROPE ISR	CARDARELLI ANGELO	289.515
2491		FCP AIR FRANCE IFC	CARDARELLI ANGELO	11.091

Manu

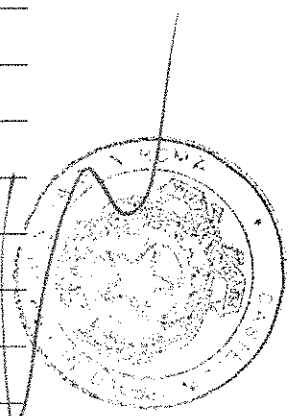

ASSEMBLEA ORDINARIA

81607/1209 12 MAGGIO 2016

Segreteria Societaria - Ufficio Titoli



eni

Unica convocazione

Esito della votazione sul punto 3

Nomina di un Amministratore ai sensi dell'articolo 2386 del Codice Civile

Elenco Favorevoli

SCHEDA	VPC	NOMINATIVO AZIONISTA	DELEGATO	NUMERO DI AZIONI TOTALE
2463		FCP AIR FRANCE IFC2	CARDARELLI ANGELO	5.592
2441		FCP ALM REUNICA DIVERSIFIE	CARDARELLI ANGELO	35.600
171		FCP AMUNDI ACTIONS INTERNATIONALES	CARDARELLI ANGELO	11
177		FCP AMUNDI ACTIONS RESSOURCES NATURELLES	CARDARELLI ANGELO	3.013
811		FCP AMUNDI HORIZON	CARDARELLI ANGELO	45.531
175		FCP AMUNDI INDEX EQUITY GLOBAL LOW CARBON	CARDARELLI ANGELO	18
176		FCP AMUNDI INDEX EQUITY GLOBAL MULTI SMART ALLOCATION SCIENTIFICBETA	CARDARELLI ANGELO	19
746		FCP AMUNDI PULSACTIONS	CARDARELLI ANGELO	22.977
135		FCP AMUNDI RENDEMENT PLUS	CARDARELLI ANGELO	7.387
820		FCP AMUNDI WORLD DIVERSIFIED FACTOR MIX	CARDARELLI ANGELO	842
2716		FCP ARPEGE ACTIONS	CARDARELLI ANGELO	15.500
766		FCP ARRCO LONG TERME C	CARDARELLI ANGELO	101.607
2711		FCP ASSOC GROUPE SAINT SAUVEUR	CARDARELLI ANGELO	1.827
791		FCP AVA EUROPE 4 FOND DEDIE'	CARDARELLI ANGELO	72.216
2695		FCP AVENIR ALIZES	CARDARELLI ANGELO	484
2495		FCP AXIVA ACTION 1	CARDARELLI ANGELO	14.330
809		FCP BERRI ACTIONS	CARDARELLI ANGELO	100.482
2466		FCP BNP PARIBAS ACTIONS EUROLAND	CARDARELLI ANGELO	317.550
2467		FCP BNP PARIBAS ACTIONS EUROPE	CARDARELLI ANGELO	10.909
2449		FCP BNP PARIBAS BEST SELECTION EURO	CARDARELLI ANGELO	173.630
2476		FCP BNPP ACTIONS EUROLAND	CARDARELLI ANGELO	851.872
771		FCP BOURBON 1	CARDARELLI ANGELO	70.000
772		FCP BOURBON 3	CARDARELLI ANGELO	35.666

ASSEMBLEA ORDINARIA 12 MAGGIO 2016

Segreteria Societaria - Ufficio Titoli



Mancini

Unica convocazione

Esito della votazione sul punto 3

Nomina di un Amministratore ai sensi dell'articolo 2386 del Codice Civile

81607/1210

Elenco Favorevoli

SCHEDA	VPC	NOMINATIVO AZIONISTA	DELEGATO	NUMERO DI AZIONI TOTALE
774	FCP	BOURBON 4	CARDARELLI ANGELO	19.895
3227	FCP	BRONGNIART RENDEMENT	CARDARELLI ANGELO	250.000
2475	FCP	CALCIUM QUANT	CARDARELLI ANGELO	41.809
2480	FCP	CAMGEST VALEURS EURO	CARDARELLI ANGELO	269.714
2645	FCP	CAPSUGEL	CARDARELLI ANGELO	3.000
210	FCP	CARPIMKO EUROPE	CARDARELLI ANGELO	121.242
2644	FCP	CIC ACTIONS 60	CARDARELLI ANGELO	2.983
3223	FCP	CM ACTIONS EURO	CARDARELLI ANGELO	257.863
2696	FCP	CM FRANCE ACTIONS	CARDARELLI ANGELO	536.692
792	FCP	CNP GGR	CARDARELLI ANGELO	9.948
155	FCP	COLOMBES 6	CARDARELLI ANGELO	62.468
161	FCP	COLOMBES 6 BIS	CARDARELLI ANGELO	100.000
2709	FCP	CONGREGATION DES SOEURS DE LA CROIX	CARDARELLI ANGELO	1.244
152	FCP	CPR ACTIVE EUROPE	CARDARELLI ANGELO	27.138
143	FCP	CPR CONSOMMATEUR ACTIONNAIRE	CARDARELLI ANGELO	13.847
777	FCP	CRN SOGE ACTIONS	CARDARELLI ANGELO	135.536
2683	FCP	CRYOSTAR FRANCE	CARDARELLI ANGELO	540
803	FCP	CURIE INVESTISSEMENTS	CARDARELLI ANGELO	30.000
2682	FCP	DEGUSSA DYNAMIQUE	CARDARELLI ANGELO	1.280
2681	FCP	DEGUSSA MIXTE	CARDARELLI ANGELO	390
2484	FCP	DIVERS D&O CAMGEST	CARDARELLI ANGELO	49.000
790	FCP	ECUREUIL PROFIL 90	CARDARELLI ANGELO	334.765
178	FCP	ECUREUIL RETRAITE EURO ACTIONS 4	CARDARELLI ANGELO	90.000

Mancini

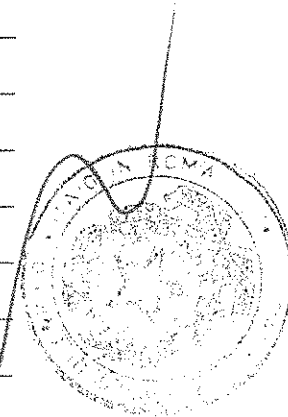

ASSEMBLEA ORDINARIA

81607/124 12 MAGGIO 2016

Segreteria Societaria - Ufficio Titoli



eni

Unica convocazione

Esito della votazione sul punto 3

Nomina di un Amministratore ai sensi dell'articolo 2386 del Codice Civile

Elenco Favorevoli

SCHEDA	VPC	NOMINATIVO AZIONISTA	DELEGATO	NUMERO DI AZIONI TOTALE
2715	FCP	EPTA	CARDARELLI ANGELO	1.851
2504	FCP	ERAFFP ACT EUR5 RO	CARDARELLI ANGELO	720.000
2692	FCP	ES GESTION EQUILIBRE	CARDARELLI ANGELO	124.430
2693	FCP	ES TEMPERE	CARDARELLI ANGELO	21.000
2679	FCP	ESSO DIVERSIFIE	CARDARELLI ANGELO	40.000
2452	FCP	EURO ETHIQUE INSTITUTIONS	CARDARELLI ANGELO	165.000
2678	FCP	EUROP ASSISTANCE DIVERSIFIE	CARDARELLI ANGELO	1.480
2680	FCP	EUROP ASSISTANCE DIVERSIFIE	CARDARELLI ANGELO	2.000
2714	FCP	FAMILLE GOETSCHY	CARDARELLI ANGELO	387
773	FCP	FDRN AMUNDI	CARDARELLI ANGELO	50.166
2469	FCP	FEDERIS ACTION	CARDARELLI ANGELO	121.948
2462	FCP	FEDERIS EURO ACTIONS	CARDARELLI ANGELO	159.100
2458	FCP	FEDERIS IRC ACTIONS	CARDARELLI ANGELO	113.920
2442	FCP	FEDERIS MM EURO ACTIONS	CARDARELLI ANGELO	4.540
2451	FCP	FEDERIS PRO ACTIONS ISR EURO	CARDARELLI ANGELO	72.455
2470	FCP	FIMA FRANCE PME	CARDARELLI ANGELO	25.436
775	FCP	FMS 3	CARDARELLI ANGELO	67.180
2691	FCP	GAILLON 130/30	CARDARELLI ANGELO	12.858
3229	FCP	GAILLON MAITRE ACTIONS	CARDARELLI ANGELO	9.004
3220	FCP	GAILLON NATURAL RESOURCES	CARDARELLI ANGELO	6.600
3222	FCP	GAILLON RENDEMENT	CARDARELLI ANGELO	111.215
2483	FCP	GERISO	CARDARELLI ANGELO	8.847
2675	FCP	GESTION PLACEMENT 1	CARDARELLI ANGELO	1.319

ASSEMBLEA ORDINARIA 12 MAGGIO 2016

Segreteria Societaria - Ufficio Titoli



eni

Mano

Unica convocazione

Esito della votazione sul punto 3

Nomina di un Amministratore ai sensi dell'articolo 2386 del Codice Civile

81607/1212

Elenco Favorevoli

SCHEDA VPC	NOMINATIVO AZIONISTA	DELEGATO	NUMERO DI AZIONI TOTALE
2671	FCP GROUPE FORD FRANCE	CARDARELLI ANGELO	7.810
2670	FCP GROUPE ROCHE	CARDARELLI ANGELO	14.200
2669	FCP GUTENBERG	CARDARELLI ANGELO	3.942
752	FCP HAMELIN DIVERSIFIE FLEX I	CARDARELLI ANGELO	30.000
205	FCP HAMELIN DIVERSIFIE FLEX II	CARDARELLI ANGELO	9.323
2668	FCP HENKEL DIVERSIFIE N 1	CARDARELLI ANGELO	900
2438	FCP HORIZONS LMG	CARDARELLI ANGELO	33.850
2446	FCP HP ACTIONS LAZARD	CARDARELLI ANGELO	235.150
802	FCP ICARE	CARDARELLI ANGELO	16
2646	FCP JET SERVICES 0291	CARDARELLI ANGELO	8.425
2486	FCP KLESIA A DIVERSIFIE	CARDARELLI ANGELO	90.000
2666	FCP LUCKY	CARDARELLI ANGELO	1.626
2665	FCP METSO MINERALS	CARDARELLI ANGELO	2.815
2664	FCP MGE DYNAMIQUE EURO	CARDARELLI ANGELO	7.400
789	FCP NATIXIS IONIS	CARDARELLI ANGELO	18.863
2468	FCP NF GALILEE	CARDARELLI ANGELO	64.370
2706	FCP OFFENSIF AIR LIQUIDE EXPANS	CARDARELLI ANGELO	13.140
201	FCP OFI OPTIMA EURO	CARDARELLI ANGELO	36.500
2663	FCP PATRIMOINE PLACEMENT 2	CARDARELLI ANGELO	1.127
2662	FCP PATRIMOINE PLACEMENT 3	CARDARELLI ANGELO	2.791
2661	FCP PATRIMOINE PLACEMENT 5	CARDARELLI ANGELO	1.792
209	FCP PHARMA PARFRANCE	CARDARELLI ANGELO	199.722
821	FCP PORTFOLIO LCR ACTIONS	CARDARELLI ANGELO	57.767

Mano

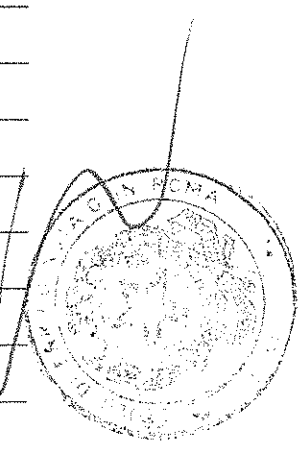

ASSEMBLEA ORDINARIA

81607/1213 12 MAGGIO 2016

Segreteria Societaria - Ufficio Titoli



eni

Unica convocazione

Esito della votazione sul punto 3

Nomina di un Amministratore ai sensi dell'articolo 2386 del Codice Civile

Elenco Favorevoli

SCHEDA	VPC	NOMINATIVO AZIONISTA	DELEGATO	NUMERO DI AZIONI TOTALE
2718		FCP PRIEURE MARQUET	CARDARELLI ANGELO	1.500
2713		FCP PYRENEES GLOBAL	CARDARELLI ANGELO	4.312
2455		FCP REGARD SEL.ACT EURO.	CARDARELLI ANGELO	210.000
2447		FCP REUNICA FORTIS	CARDARELLI ANGELO	149.380
798		FCP RL PREVOYANCE	CARDARELLI ANGELO	40.616
751		FCP RSI EURO P	CARDARELLI ANGELO	92.236
800		FCP RSI EURO P	CARDARELLI ANGELO	239.965
796		FCP RSRC DIVERSIFIE	CARDARELLI ANGELO	145.888
2705		FCP SAINT ARBOGAST	CARDARELLI ANGELO	1.428
2445		FCP SAINT MARTIN 3	CARDARELLI ANGELO	173.050
2497		FCP SAINT MARTIN 4	CARDARELLI ANGELO	240.000
2444		FCP SAINT MARTIN N1	CARDARELLI ANGELO	120.347
2440		FCP SAKKARAH 2	CARDARELLI ANGELO	30.500
2450		FCP SAKKARAH 5	CARDARELLI ANGELO	52.000
3207		FCP SAKKARAH 6	CARDARELLI ANGELO	50.000
2496		FCP SAKKARAH 7	CARDARELLI ANGELO	62.358
2701		FCP SCORE 2012	CARDARELLI ANGELO	1.036
2685		FCP SCORE 620	CARDARELLI ANGELO	3.000
2659		FCP SCORE AD BESANCON	CARDARELLI ANGELO	1.889
2658		FCP SCORE AUMEX	CARDARELLI ANGELO	3.602
2657		FCP SCORE GALIEN	CARDARELLI ANGELO	5.399
2717		FCP SCORE M A R S	CARDARELLI ANGELO	316
2656		FCP SCORE M O	CARDARELLI ANGELO	1.354

ASSEMBLEA ORDINARIA 12 MAGGIO 2016

Segreteria Societaria - Ufficio Titoli



Quercia

Unica convocazione

Esito della votazione sul punto 3

Nomina di un Amministratore ai sensi dell'articolo 2386 del Codice Civile

81607/1214

Elenco Favorevoli

SCHEDA	VPC	NOMINATIVO AZIONISTA	DELEGATO	NUMERO DI AZIONI TOTALE
2704	FCP SCORE	MARIE JOSEPH	CARDARELLI ANGELO	5.182
2655	FCP SCORE	ORMESSON	CARDARELLI ANGELO	3.012
2654	FCP SCORE	PILLAUD	CARDARELLI ANGELO	1.910
2651	FCP SCORE	SAINT JOSEPH	CARDARELLI ANGELO	1.816
2652	FCP SCORE	SAINTE URSULE	CARDARELLI ANGELO	2.973
2700	FCP SCORE	SAXE	CARDARELLI ANGELO	8.092
2699	FCP SCORE	SIGMA	CARDARELLI ANGELO	6.952
2650	FCP SCORE	THANRY	CARDARELLI ANGELO	1.307
779	FCP TONI	ACTIONS 100	CARDARELLI ANGELO	21.368
3228	FCP TRANSAT	PATRIMOINE 2	CARDARELLI ANGELO	140.000
2687	FCP TROUVU		CARDARELLI ANGELO	915
154	FCP UBAM	ACTIONS EURO RENDEMENT	CARDARELLI ANGELO	217.459
2474	FCP UBS F	EURO OPPORT UNCON PEA EUR	CARDARELLI ANGELO	34.443
3225	FCP UNION	EUROPE	CARDARELLI ANGELO	259.076
3224	FCP UNION	FRANCE	CARDARELLI ANGELO	42.886
3221	FCP UNION	LONG SHORT EUROPE	CARDARELLI ANGELO	16.399
793	FCP VILLIERS	ALLEGRO	CARDARELLI ANGELO	305.438
780	FCP VIVACCIO	ACTIONS	CARDARELLI ANGELO	158.400
2698	FCPE ACCOR	DIVERSIFIE	CARDARELLI ANGELO	6.660
763	FCPE AMUNDI	LABEL DYNAMIQUE	CARDARELLI ANGELO	16
757	FCPE AMUNDI	LABEL EQUILIBRE	CARDARELLI ANGELO	16
762	FCPE AMUNDI	LABEL PRUDENCE	CARDARELLI ANGELO	14
153	FCPE AMUNDI	PREM PATRIMOINE	CARDARELLI ANGELO	33

Quercia

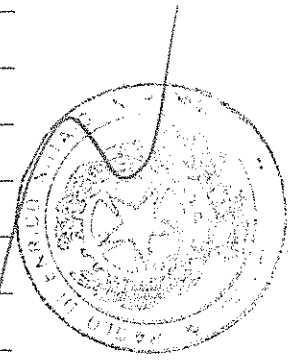

ASSEMBLEA ORDINARIA

81607/1215 12 MAGGIO 2016

Segreteria Societaria - Ufficio Titoli



eni

Unica convocazione

Esito della votazione sul punto 3

Nomina di un Amministratore ai sensi dell'articolo 2386 del Codice Civile

Elenco Favorevoli

SCHEDA	VPC	NOMINATIVO AZIONISTA	DELEGATO	NUMERO DI AZIONI TOTALE
141		FCPE AMUNDI RESA ACTIONS EUROPE	CARDARELLI ANGELO	17
144		FCPE AMUNDI RESA ESG ACTIONS EURO	CARDARELLI ANGELO	477
2640		FCPE AREVA ACTIONS	CARDARELLI ANGELO	34.827
2488		FCPE AXA GENERATION EUROPE ACTIONS	CARDARELLI ANGELO	269.000
2689		FCPE BARCLAYS DIVERIFIE ACTIONS	CARDARELLI ANGELO	10.000
2686		FCPE COFACE	CARDARELLI ANGELO	4.000
2708		FCPE CONVERGENCE ACTIONS EUROPE	CARDARELLI ANGELO	33.000
2690		FCPE CONVERGENCE DIVERSIFIE	CARDARELLI ANGELO	90.500
2707		FCPE FONCIL	CARDARELLI ANGELO	12.000
2464		FCPE GPE FMC FCE DIV BNP	CARDARELLI ANGELO	2.612
2482		FCPE HORIZON EP. ACTION	CARDARELLI ANGELO	14.000
742		FCPE JUNON ACTIONS OBLIGATIONS	CARDARELLI ANGELO	103.105
2465		FCPE LIMACTIF	CARDARELLI ANGELO	3.024
801		FCPE NATIXIS ES ACTIONS EURO	CARDARELLI ANGELO	60.550
2660		FCPE PIPE LINE SUD EUROPEEN	CARDARELLI ANGELO	2.500
202		FCPE SAIPEM ACTIONS	CARDARELLI ANGELO	6.000
806		FCPE TECHNIP DYNAMIQUE	CARDARELLI ANGELO	10.458
807		FCPE TECHNIP EQUILIBRE	CARDARELLI ANGELO	12.080
2647		FCPE THALES AVIONICS	CARDARELLI ANGELO	4.040
2493		FCPE TOTAL ACTIONS EUROPEENNES	CARDARELLI ANGELO	450.000
2254		FCPE TOTAL DIV A DOM ACTIONS	CARDARELLI ANGELO	112.358
2688		FCP_CAGNI	CARDARELLI ANGELO	7.800
159		FDC A2	CARDARELLI ANGELO	207.521

ASSEMBLEA ORDINARIA 12 MAGGIO 2016

Segreteria Societaria - Ufficio Titoli



L
M
M

Unica convocazione

Esito della votazione sul punto 3

Nomina di un Amministratore ai sensi dell'articolo 2386 del Codice Civile

81607/1216

Elenco Favorevoli

SCHEDA VPC	NOMINATIVO AZIONISTA	DELEGATO	NUMERO DI AZIONI TOTALE
166	FDC A6 POCHE TITRES	CARDARELLI ANGELO	72.700
2262	FDJ ACTIONS EURO	CARDARELLI ANGELO	21.431
1221	FEDERATED CITY EMPLOYEES RETIREMENT SYSTEM	CARDARELLI ANGELO	47.752
2477	FEDERIS AVENIR EURO-PE	CARDARELLI ANGELO	27.700
2457	FEDERIS EPARGNE EQUILIBREE	CARDARELLI ANGELO	7.080
1032	FEDEX CORPORATION EMPLOYEES PENSION TRUST	CARDARELLI ANGELO	37.736
1878	FIDELITY ADVISOR SERIES VIII FIDELITY ADVISOR OVERSEAS FUND	CARDARELLI ANGELO	60.300
354	FIDELITY CONCORD STREET TRUST SPARTAN INTERNATIONAL INDEX FUND	CARDARELLI ANGELO	3.045.285
2361	FIDELITY CONTRAFUND	CARDARELLI ANGELO	716.400
2422	FIDELITY CONTRAFUND FID ADVISOR NEW INSI	CARDARELLI ANGELO	101.500
2377	FIDELITY FUNDS SICAV	CARDARELLI ANGELO	6.236.667
2378	FIDELITY FUNDS SICAV	CARDARELLI ANGELO	278.354
2406	FIDELITY GROUP TRUST FOR EMPLOYEE BENEFI	CARDARELLI ANGELO	800.000
1877	FIDELITY HASTINGS STREET TRUST: FIDELITY FUND	CARDARELLI ANGELO	273.600
3086	FIDELITY INVESTMENT FUNDS - FIDELIT	CARDARELLI ANGELO	98.965
3087	FIDELITY INVESTMENT FUNDS - FIDELITY MONEYBUILDER WORLD INDEX FUND	CARDARELLI ANGELO	30.122
881	FIDELITY INVESTMENT TRUST: FIDELITY GLOBAL COMMODITY STOCK F	CARDARELLI ANGELO	58.000
882	FIDELITY INVESTMENT TRUST: FIDELITY SERIES INTVALUE FUND	CARDARELLI ANGELO	10.159.700
879	FIDELITY INVESTMENT TRUST: FIDELITY TOTAL INT EQUITY FUND	CARDARELLI ANGELO	94.900
3125	FIDELITY INVESTMENTS MONEY MANAGEMENT INC	CARDARELLI ANGELO	270
3139	FIDELITY INVESTMENTS MONEY MANAGEMENT INC	CARDARELLI ANGELO	1.021
3140	FIDELITY INVESTMENTS MONEY MANAGEMENT INC	CARDARELLI ANGELO	360
1027	FIDELITY NORTHSTAR FUND	CARDARELLI ANGELO	2.200.000

L
M
M

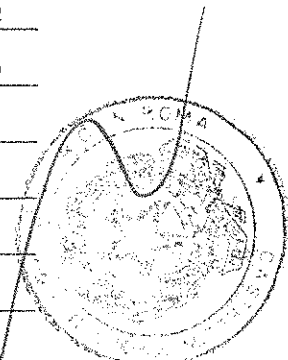

ASSEMBLEA ORDINARIA

81607/1217 12 MAGGIO 2016

Segreteria Societaria - Ufficio Titoli



eni

Unica convocazione

Esito della votazione sul punto 3

Nomina di un Amministratore ai sensi dell'articolo 2386 del Codice Civile

Elenco Favorevoli

SCHEDA	VPC	NOMINATIVO AZIONISTA	DELEGATO	NUMERO DI AZIONI TOTALE
2401		FIDELITY PURITAN TF LOW PRICE STOCK FUND	CARDARELLI ANGELO	8.000.000
880		FIDELITY RUTLAND SQUARE TR II: STRAT ADV INT MULTI-MANAGER F	CARDARELLI ANGELO	7.009
883		FIDELITY RUTLAND SQUARETRUST II: STRATEGIC ADVISERS INT F	CARDARELLI ANGELO	788.772
884		FIDELITY RUTLAND SQUARETRUST II: STRATEGIC ADVISERS INT F	CARDARELLI ANGELO	546.600
885		FIDELITY RUTLAND SQUARETRUST II: STRATEGIC ADVISERS INT F	CARDARELLI ANGELO	115.304
2397		FIDELITY SAL ST SPARTAN GLOBAL EX US IN	CARDARELLI ANGELO	194.880
1879		FIDELITY SALEM STREET TRUST FIDELITY SERIES GLOBAL EX U.S. INDEX FUND	CARDARELLI ANGELO	476.988
417		FIDELITY SALEM STREET TRUST FIDELITY SAI INTERNATIONAL INDEXFUND	CARDARELLI ANGELO	106.892
3233		FIDUCIARY TRUST COMPANY INTERNATIONAL AS	CARDARELLI ANGELO	25.567
736		FIRE AND POLICE PENSION ASSOCIATION OF COLOR	CARDARELLI ANGELO	39.527
737		FIRE AND POLICE PENSION ASSOCIATION OF COLOR	CARDARELLI ANGELO	2.576
1960		FIREMEN'S ANNUITY & BENEFIT FUND OF CHICAGO	CARDARELLI ANGELO	106.700
2800		FIRST CLEARING LLC	CARDARELLI ANGELO	20.158
2280		FIRST EAGLE AMUNDI INCOME BUIL	CARDARELLI ANGELO	21.348
1196		FIRST EAGLE GLOBAL INCOME BUILDER FUND	CARDARELLI ANGELO	53.369
1703		FIRST STATE INVESTMENTS ICVC-FIRST STATE DIVERSIFIED GROWTH F	CARDARELLI ANGELO	770
455		FIRST TRUST ISE GLOBAL COPPER INDEX FUND	CARDARELLI ANGELO	73.881
2424		FIRST TRUST RIVERFRONT DYN DEV INT ETF	CARDARELLI ANGELO	3.490
2423		FIRST TRUST RIVERFRONT DYNAMIC EUROPE ET	CARDARELLI ANGELO	4.670
1364		FLEXIBLE PORTFOLIO	CARDARELLI ANGELO	50.000
2950		FLEXSHARES INTERNATIONAL QUALITY DIVIDEND DEFENSIVE INDEX FUND	CARDARELLI ANGELO	41.600
2951		FLEXSHARES INTERNATIONAL QUALITY DIVIDEND INDEX FUND	CARDARELLI ANGELO	21.444
2952		FLEXSHARES INTERNATIONAL QUALITY DIVIDEND INDEX FUND	CARDARELLI ANGELO	266.490

ASSEMBLEA ORDINARIA 12 MAGGIO 2016

Segreteria Societaria - Ufficio Titoli



[Handwritten signature]

Unica convocazione

Esito della votazione sul punto 3

Nomina di un Amministratore ai sensi dell'articolo 2386 del Codice Civile

81607/1218

Elenco Favorevoli

SCHEDA	VPC	NOMINATIVO AZIONISTA	DELEGATO	NUMERO DI AZIONI TOTALE
2935		FLEXSHARES MORNINGSTAR DEVELOPED MARKETS EX-US FACTOR TILT INDEX FUND	CARDARELLI ANGELO	46.939
2941		FLEXSHARES MORNINGSTAR GLOBAL UPSTREAM N	CARDARELLI ANGELO	994.042
3178		FLF EUROPE EQUITY EX UK FUND	CARDARELLI ANGELO	1.747.725
3173		FLF STRATEGIC GLOBAL EQUITY FUND	CARDARELLI ANGELO	74.987
546		FLORIDA BIRTH-RELATED NEUROLOGICAL INJURY COMPENSATION ASSOCIATION ASSOC	CARDARELLI ANGELO	46.213
1758		FLORIDA COLLEGE SAVINGS PROGRAM	CARDARELLI ANGELO	4.863
739		FLORIDA GLOBAL EQUITY FUND LLC	CARDARELLI ANGELO	27.188
1961		FLORIDA PREPAID COLLEGE PROGRAM	CARDARELLI ANGELO	30.230
547		FLORIDA RETIREMENT SYSTEM .	CARDARELLI ANGELO	49.776
548		FLORIDA RETIREMENT SYSTEM .	CARDARELLI ANGELO	120.264
549		FLORIDA RETIREMENT SYSTEM .	CARDARELLI ANGELO	1.404.621
550		FLORIDA RETIREMENT SYSTEM .	CARDARELLI ANGELO	393.626
551		FLORIDA RETIREMENT SYSTEM .	CARDARELLI ANGELO	1.109.358
497		FLORIDA STATE BOARD OF ADMINISTRATION	CARDARELLI ANGELO	24.470
1193		FLOURISH INVESTMENT CORPORATION	CARDARELLI ANGELO	882.412
1194		FLOURISH INVESTMENT CORPORATION	CARDARELLI ANGELO	116.015
1195		FLOURISH INVESTMENT CORPORATION	CARDARELLI ANGELO	135.743
1198		FLOURISH INVESTMENT CORPORATION	CARDARELLI ANGELO	1.503.023
1199		FLOURISH INVESTMENT CORPORATION	CARDARELLI ANGELO	1.432.318
1204		FLOURISH INVESTMENT CORPORATION	CARDARELLI ANGELO	1.427.042
92		FOCUSED SICAV GLOBAL EQUITY STRATEGY (USD)	CARDARELLI ANGELO	13.246
3279		FOLKSAM OMESESIDIG LIVFORSKRING	CARDARELLI ANGELO	130.570
3285		FOLKSAM OMESESIDIG LIVFORSKRING	CARDARELLI ANGELO	153.278

[Handwritten signature]

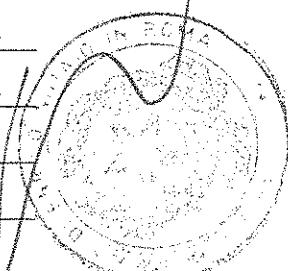

ASSEMBLEA ORDINARIA

81607/1219 12 MAGGIO 2016

Segreteria Societaria - Ufficio Titoli



eni

Unica convocazione

Esito della votazione sul punto 3

Nomina di un Amministratore ai sensi dell'articolo 2386 del Codice Civile

Elenco Favorevoli

SCHEDA	VPC	NOMINATIVO AZIONISTA	DELEGATO	NUMERO DI AZIONI TOTALE
3284		FOLKSAM OMESESIDIG SAKFORSAKRING	CARDARELLI ANGELO	14.868
123		FONDACO ROMA EURO BALANCED CORE	CARDARELLI ANGELO	18.765
122		FONDACO ROMA GLOBAL EQUITY SATELLITE II	CARDARELLI ANGELO	96.675
3164		FONDATION J.ARMAND BOMBARDIER	CARDARELLI ANGELO	8.613
2558		FONDS ASSECURA I	CARDARELLI ANGELO	2.063
1007		FONDS DGIA ACTIONS MONDIALES GRANDE CAPITALISATION	CARDARELLI ANGELO	29.741
1006		FONDS PRIVE GPD ACTIONS INTERNATIONALES	CARDARELLI ANGELO	50.000
2501		FONDS RESERVE RETRAITES	CARDARELLI ANGELO	355.340
1833		FOOD & AGRICULTURE ORGANISATION OF THE UNITED NATIONS.	CARDARELLI ANGELO	14.214
1905		FORD MOTOR COMPANY DEFINED BENEFIT MASTER TRUST	CARDARELLI ANGELO	42.672
1906		FORD MOTOR COMPANY DEFINED BENEFIT MASTER TRUST	CARDARELLI ANGELO	45.314
1989		FORD MOTOR COMPANY OF CANADA, LIMITED PENSION TRUST	CARDARELLI ANGELO	18.051
3036		FOREIGN AND COLONIAL INVESTMENT TRUST PL	CARDARELLI ANGELO	363.102
3283		FORENADE LIV GRUPPOFORSAKRING AB (PUBL)	CARDARELLI ANGELO	2.443
2694		FRANCE ACTION 250	CARDARELLI ANGELO	11.311
1029		FRANCISCAN ALLIANCE, INC.	CARDARELLI ANGELO	136.578
451		FRANCISCAN ALLIANCE, INC. MASTER PENSION TRUST	CARDARELLI ANGELO	87.420
2926		FRANKLIN T.VARIABLE INSURANCE PRODUCTS T	CARDARELLI ANGELO	776.759
2747		FRANKLIN TEMPLETON INVESTMENT FUNDS	CARDARELLI ANGELO	506.632
2748		FRANKLIN TEMPLETON INVESTMENT FUNDS	CARDARELLI ANGELO	305.700
2749		FRANKLIN TEMPLETON INVESTMENT FUNDS	CARDARELLI ANGELO	362.081
2750		FRANKLIN TEMPLETON INVESTMENT FUNDS	CARDARELLI ANGELO	842.075
2751		FRANKLIN TEMPLETON INVESTMENT FUNDS	CARDARELLI ANGELO	18.879

ASSEMBLEA ORDINARIA 12 MAGGIO 2016

Segreteria Societaria - Ufficio Titoli

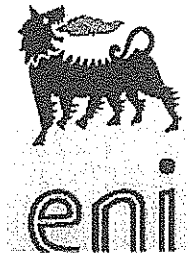

L

Unica convocazione

Esito della votazione sul punto 3

Nomina di un Amministratore ai sensi dell'articolo 2386 del Codice Civile

81607/1220

Elenco Favorevoli

SCHEDA	VPC	NOMINATIVO AZIONISTA	DELEGATO	NUMERO DI AZIONI TOTALE
2752		FRANKLIN TEMPLETON INVESTMENT FUNDS	CARDARELLI ANGELO	4.255.215
2753		FRANKLIN TEMPLETON INVESTMENT FUNDS	CARDARELLI ANGELO	320.266
2754		FRANKLIN TEMPLETON INVESTMENT FUNDS	CARDARELLI ANGELO	191.198
2755		FRANKLIN TEMPLETON INVESTMENT FUNDS	CARDARELLI ANGELO	1.138.529
2767		FRANKLIN TEMPLETON INVESTMENT FUNDS	CARDARELLI ANGELO	17.893
2775		FRANKLIN TEMPLETON INVESTMENT FUNDS	CARDARELLI ANGELO	436.158
240		FRANKLIN TEMPLETON INVESTMENTS	CARDARELLI ANGELO	206.258
3195		FRANKLIN TEMPLETON SHARIAH FUNDS 8A	CARDARELLI ANGELO	56.528
358		FRANKLIN TEMPLETON SINOAM GLOBAL GROWTH FUND	CARDARELLI ANGELO	44.315
2939		FRANKLIN TEMPLETON VARIAB. INSURANCE	CARDARELLI ANGELO	1.349.435
1691		FRIENDS LIFE LIMITED	CARDARELLI ANGELO	161.227
1692		FRIENDS LIFE LIMITED	CARDARELLI ANGELO	33.996
1693		FRIENDS LIFE LIMITED	CARDARELLI ANGELO	3.204
1694		FRIENDS LIFE LIMITED	CARDARELLI ANGELO	5.799
1695		FRIENDS LIFE LIMITED	CARDARELLI ANGELO	5.094
1696		FRIENDS LIFE LIMITED	CARDARELLI ANGELO	3.558
1697		FRIENDS LIFE LIMITED	CARDARELLI ANGELO	3.136
552		FRONTIERS INTERNATIONAL EQUITY POOL	CARDARELLI ANGELO	19.950
2502		FRR	CARDARELLI ANGELO	429.336
2834		FSS TRUSTEE CORPORATION	CARDARELLI ANGELO	44.091
2837		FSS TRUSTEE CORPORATION	CARDARELLI ANGELO	333.078
266		FT DOW JONES GLOBAL SELECT DIVIDEND INDEXFUND	CARDARELLI ANGELO	241.471
2945		FUNDACAO CALOUSTE GULBENKIAN	CARDARELLI ANGELO	65.355

L

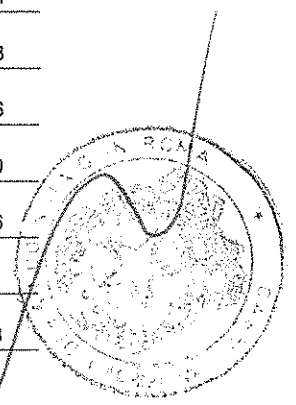

ASSEMBLEA ORDINARIA

81607/1221

12 MAGGIO 2016

Segreteria Societaria - Ufficio Titoli



eni

Unica convocazione

Esito della votazione sul punto 3

Nomina di un Amministratore ai sensi dell'articolo 2386 del Codice Civile

Elenco Favorevoli

SCHEDA	VPC	NOMINATIVO AZIONISTA	DELEGATO	NUMERO DI AZIONI TOTALE
1807		FUNDO DE PENSOES	CARDARELLI ANGELO	72.827
1996		FUTURE FUND BOARD OF GUARDIANS FOR AND ON BEHALF OF FUTURE F	CARDARELLI ANGELO	145.672
3175		Friends Life Limited	CARDARELLI ANGELO	678.468
3176		Friends Life Limited	CARDARELLI ANGELO	73.252
3177		Friends Life Limited	CARDARELLI ANGELO	7.476
3256		Friends Life Limited	CARDARELLI ANGELO	12.612
146		G FINANCIER AMUNDI	CARDARELLI ANGELO	18
2599		GA FUND L	CARDARELLI ANGELO	5.037
1041		GABELLI EQUITY INCOME FUND	CARDARELLI ANGELO	29.000
2855		GAMMA EMIRATES INVESTMENT L.L.C. EM	CARDARELLI ANGELO	6.821
2000		GARD COMMON CONTRACTUAL FUND	CARDARELLI ANGELO	33.150
1606		GE INVESTMENTS FUNDS, INC. - TOTAL RETURN FUND	CARDARELLI ANGELO	86.297
982		GENERAL CONFERENCE CORPORATION OF SEVENTH DAY ADVENTISTS	CARDARELLI ANGELO	9.360
1505		GENERAL CONFERENCE CORPORATION OF SEVENTH DAY ADVENTISTS	CARDARELLI ANGELO	93.539
1043		GENERAL ELECTRIC PENSION TRUST	CARDARELLI ANGELO	18.655
1044		GENERAL ELECTRIC PENSION TRUST	CARDARELLI ANGELO	268.925
1964		GENERAL PENSION AND SOCIAL SECURITY AUTHORITY	CARDARELLI ANGELO	75.814
1965		GENERAL PENSION AND SOCIAL SECURITY AUTHORITY	CARDARELLI ANGELO	96.840
855		GEORGES R. HAIRK PARAMETRICO PORTFOLIO ASSOCIATES	CARDARELLI ANGELO	1.222
1190		GEUT PAN EUROPEAN EQUITY INDEX FUND	CARDARELLI ANGELO	149.433
2736		GIVI GLOBAL EQUITY FUND CLT AC	CARDARELLI ANGELO	42.517
657		GLAXOSMITHKLINE MASTER RETIREMENT TRUST	CARDARELLI ANGELO	155.004
405		GLG INVESTMENTS PLC	CARDARELLI ANGELO	24.420

ASSEMBLEA ORDINARIA 12 MAGGIO 2016

Segreteria Societaria - Ufficio Titoli



Mani
81607/1222

Unica convocazione

Esito della votazione sul punto 3

Nomina di un Amministratore ai sensi dell'articolo 2386 del Codice Civile

Elenco Favorevoli

SCHEDA	VPC	NOMINATIVO AZIONISTA	DELEGATO	NUMERO DI AZIONI TOTALE
1344		GLOBAL ADVANTAGE FUNDS - MAJOR MARKETS TEILFONDS	CARDARELLI ANGELO	180.467
1464		GLOBAL ALPHA TILTS FUND B	CARDARELLI ANGELO	5.446
604		GLOBAL DIVIDEND CLASS (SETANTA)	CARDARELLI ANGELO	364.258
606		GLOBAL EQUITY CLASS (SETANTA)	CARDARELLI ANGELO	24.197
1471		GLOBAL EX US ALPHA TILTS FUND B	CARDARELLI ANGELO	47.005
2243		GLOBAL HIGH INCOME EQUITY	CARDARELLI ANGELO	41.150
1456		GLOBAL MULTI-CAP EQUITY FUND B	CARDARELLI ANGELO	12.550
2420		GLOBAL X SCIENTIFIC BETA EUROPE ETF	CARDARELLI ANGELO	1.146
946		GMAM INVESTMENT FUNDS TRUST	CARDARELLI ANGELO	85.987
947		GMAM INVESTMENT FUNDS TRUST	CARDARELLI ANGELO	225.355
1081		GMO AGGRESSIVE LONG/SHORT MASTER PORTFOLIO	CARDARELLI ANGELO	70.430
2364		GMO Alpha Only Fund	CARDARELLI ANGELO	15.797
1079		GMO BENCHMARK-FREE FUND	CARDARELLI ANGELO	242.089
2370		GMO DEVELOPED WORLD STOCK FUND	CARDARELLI ANGELO	93.337
2363		GMO ERISA POOL	CARDARELLI ANGELO	383.021
2366		GMO FOREIGN FUND	CARDARELLI ANGELO	159.311
2391		GMO FUNDS PLC	CARDARELLI ANGELO	56.357
2393		GMO FUNDS PLC	CARDARELLI ANGELO	501.753
1739		GMO GLOBAL EQUITY TRUST	CARDARELLI ANGELO	11.258
1082		GMO IMPLEMENTATION FUND	CARDARELLI ANGELO	2.051.536
2365		GMO INTERNATIONAL EQUITY FUND	CARDARELLI ANGELO	5.933.817
2371		GMO INTERNATIONAL LARGE/MID CAP EQUITY F	CARDARELLI ANGELO	1.052.942
2400		GMO RESOURCES FUND	CARDARELLI ANGELO	14.506

Mani

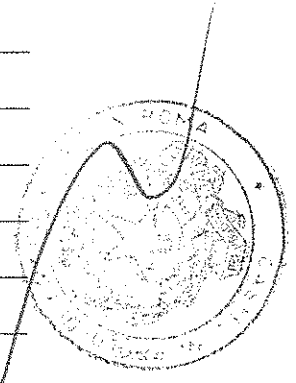

ASSEMBLEA ORDINARIA

81607/1223 12 MAGGIO 2016

Segreteria Societaria - Ufficio Titoli



eni

Unica convocazione

Esito della votazione sul punto 3

Nomina di un Amministratore ai sensi dell'articolo 2386 del Codice Civile

Elenco Favorevoli

SCHEDA	VPC	NOMINATIVO AZIONISTA	DELEGATO	NUMERO DI AZIONI TOTALE
1080		GMO TAX-MANAGED GLOBAL BALANCED PORTFOLIO	CARDARELLI ANGELO	2.512
2362		GMO TAX-MANAGED INTERNATIONAL EQUITIES F	CARDARELLI ANGELO	84.776
2399		GMO WORLD EQUITYALLOCATION INVESTMENT FU	CARDARELLI ANGELO	205.017
2382		GOLD S SEL INV TR MULTIAS ENH VAL FUND	CARDARELLI ANGELO	38.101
381		GOLDMAN SACHS ETF TRUST- GOLDMAN SACHS ACTIVE BETA INTER. EQUITY	CARDARELLI ANGELO	6.471
382		GOLDMAN SACHS ETF TRUST-GOLDMANSACHS ACTIVE BETA EUROPE EQITY	CARDARELLI ANGELO	4.264
1374		GOLDMAN SACHS FUNDS	CARDARELLI ANGELO	51.179
1375		GOLDMAN SACHS FUNDS	CARDARELLI ANGELO	15.054
1376		GOLDMAN SACHS FUNDS	CARDARELLI ANGELO	305.671
1377		GOLDMAN SACHS FUNDS	CARDARELLI ANGELO	169.685
291		GOLDMAN SACHS INSTITUTIONAL FUNDS PLC	CARDARELLI ANGELO	54.148
2958		GOLDMAN SACHS STRUCTURED INTERNATIONAL T	CARDARELLI ANGELO	296.582
3102		GOLDMAN SACHS TRUST - GOLDMAN SACHS INTE	CARDARELLI ANGELO	121.624
2957		GOLDMAN SACHS TRUST - GOLDMAN SACHS STRUCTURED INTERNATIONAL TAX-MANAGED EQUITY	CARDARELLI ANGELO	394.622
923		GOLDMAN SACHS TRUST II - MULTI-MANAGER INTERNL EQUITY FUND	CARDARELLI ANGELO	21.241
1704		GOLDMAN SACHS UK RETIREMENT PLAN	CARDARELLI ANGELO	2.869
372		GOUDSE LEVENSVERZEKERINGEN N.V.	CARDARELLI ANGELO	42.500
1197		GOV OF HM THE SULTAN AND YANG DI-PERTUAN OF BRUNEI DARUSSALAM	CARDARELLI ANGELO	116.223
380		GOVERNMENT EMPLOYEES PENSION FUND	CARDARELLI ANGELO	336.567
1668		GOVERNMENT INSTITUTIONS PENSION FUND	CARDARELLI ANGELO	90.886
86		GOVERNMENT OF NORWAY	CARDARELLI ANGELO	50.710.595
2844		GOVERNMENT SUPERANNUATION FUND	CARDARELLI ANGELO	26.139
2845		GOVERNMENT SUPERANNUATION FUND	CARDARELLI ANGELO	126.375

ASSEMBLEA ORDINARIA 12 MAGGIO 2016

Segreteria Societaria - Ufficio Titoli



Man

Unica convocazione

Esito della votazione sul punto 3

Nomina di un Amministratore ai sensi dell'articolo 2386 del Codice Civile

81607/1224

Elenco Favorevoli

SCHEDA	VPC	NOMINATIVO AZIONISTA	DELEGATO	NUMERO DI AZIONI TOTALE
2674	GP 1	VITALITE FCPE	CARDARELLI ANGELO	8.000
2673	GP 2	CROISSANCE FCPE	CARDARELLI ANGELO	6.000
2672	GP 3	MATURITE FCPE	CARDARELLI ANGELO	2.000
379	GRAND LODGE OF FREE AND ACCEPTED MASONS OF CALIFORNIA		CARDARELLI ANGELO	50.682
815	GRD 18	ACTIONS	CARDARELLI ANGELO	71.486
753	GRD ACTIONS	ZONE EURO	CARDARELLI ANGELO	131.970
1842	GRIFFIN FAMILY TRUST		CARDARELLI ANGELO	62.052
2720	GROUPE E I M I		CARDARELLI ANGELO	553
605	GROWTH AND INCOME CLASS (GWLIM)		CARDARELLI ANGELO	19.145
265	GS TACS MARKET CONTINUOUS (INTL) LLC		CARDARELLI ANGELO	185.999
328	GUGGENHEIM VARIABLE FUNDS TRUSTSERIES D (WORLD EQUITY INCOMES)		CARDARELLI ANGELO	36.500
1785	GUIDE STONE FUNDS INTERNATIONAL EQUITY INDEX FUNDS		CARDARELLI ANGELO	24.812
250	GUIDEMARK WORLD EX - US FUND		CARDARELLI ANGELO	3.143
1786	GUIDESTONE FUNDS GLOBAL NATURAL RESOURCES EQUITY FUND		CARDARELLI ANGELO	59.246
1780	GUIDESTONE FUNDS INTERNATIONAL EQUITY FUND		CARDARELLI ANGELO	481.185
1781	GUIDESTONE FUNDS INTERNATIONAL EQUITY FUND		CARDARELLI ANGELO	311.280
2830	H.E.S.T. AUSTRALIA LIMITED		CARDARELLI ANGELO	60.481
2831	H.E.S.T. AUSTRALIA LIMITED		CARDARELLI ANGELO	25.931
2832	H.E.S.T. AUSTRALIA LIMITED		CARDARELLI ANGELO	13.980
2833	H.E.S.T. AUSTRALIA LIMITED		CARDARELLI ANGELO	31.628
1884	HAGFORS LIMITED		CARDARELLI ANGELO	59.152
2255	HALEVY A2		CARDARELLI ANGELO	142.677
1992	HALIFAX REGIONAL MUNICIPALITY MASTER TRUST		CARDARELLI ANGELO	2.898

Man

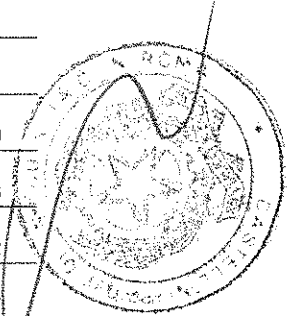

ASSEMBLEA ORDINARIA81607/1225 **12 MAGGIO 2016**

Segreteria Societaria - Ufficio Titoli

**eni**

Unica convocazione

Esito della votazione sul punto 3

Nomina di un Amministratore ai sensi dell'articolo 2386 del Codice Civile**Elenco Favorevoli**

SCHEDA	VPC	NOMINATIVO AZIONISTA	DELEGATO	NUMERO DI AZIONI TOTALE
1993		HALIFAX REGIONAL MUNICIPALITY MASTER TRUST	CARDARELLI ANGELO	12.176
1994		HALIFAX REGIONAL MUNICIPALITY MASTER TRUST	CARDARELLI ANGELO	2.855
799		HAMELIN DIVERSIFIE PERP	CARDARELLI ANGELO	700
3081		HANDELSBANKENS EUROPAFOND INDEX	CARDARELLI ANGELO	246.449
138		HARMO PLACEMENT 2	CARDARELLI ANGELO	50.630
482		HARMONY OVERSEAS EQUITY POOL	CARDARELLI ANGELO	40.821
418		HARRIS UNIT 1 QUALIFIED NUCLEARDECOMMISSIONING FUND	CARDARELLI ANGELO	7.562
1063		HARTFORD HEALTHCARE CORP DEFINED BENEFIT MASTER TR AGREEMENT	CARDARELLI ANGELO	34.837
1062		HARTFORD HEALTHCARE ENDOWMENT LLC	CARDARELLI ANGELO	25.312
2242		HARTFORD INTERNATIONAL	CARDARELLI ANGELO	52.510
1054		HARTFORD INTERNATIONAL EQUITY FUND	CARDARELLI ANGELO	12.075
1051		HARTFORD INTERNATIONAL OPPORTUNITIES HLS FUND	CARDARELLI ANGELO	574.168
1137		HARTFORD LIFE INSURANCE COMPANY	CARDARELLI ANGELO	16.569
3107		HARTFORD LIFE INSURANCE COMPANY	CARDARELLI ANGELO	61.823
1689		HBOS INTERNATIONAL INV FUNDS ICVC- EUROPEAN FUND	CARDARELLI ANGELO	138.404
1690		HBOS INTERNATIONAL INV FUNDS ICVC- INTERNATIONAL GROWTH FUND	CARDARELLI ANGELO	594.574
872		HC CAPITAL TRUST - THE ESG GROWTH PORTFOLIO	CARDARELLI ANGELO	24.930
868		HC CAPITAL TRUST THE COMMODITY RETURNS STRATEGY PORTFOLIO	CARDARELLI ANGELO	427.965
871		HC CAPITAL TRUST THE COMMODITY RETURNS STRATEGY PORTFOLIO	CARDARELLI ANGELO	550.670
873		HC CAPITAL TRUST- THE CATHOLIC SRI GROWTH PORTFOLIO	CARDARELLI ANGELO	4.316
870		HC CAPITAL TRUST- THE INSTITUTIONAL INTERNATIONAL EQUITY PTF	CARDARELLI ANGELO	537.042
448		HCC INTERNATIONAL INSURANCE COMPANY PLC	CARDARELLI ANGELO	1.222
2677		HEINEKEN ENTREPRISE DIVERSIFIE	CARDARELLI ANGELO	1.500

ASSEMBLEA ORDINARIA 12 MAGGIO 2016

Segreteria Societaria - Ufficio Titoli



L
3
2

Unica convocazione

Esito della votazione sul punto 3

Nomina di un Amministratore ai sensi dell'articolo 2386 del Codice Civile

81607/1226

Elenco Favorevoli

SCHEDA	VPC	NOMINATIVO AZIONISTA	DELEGATO	NUMERO DI AZIONI TOTALE
392		HEINZ 1975 PENSION PLAN	CARDARELLI ANGELO	176.097
391		HEINZ MANAGEMENT PENSION PLAN	CARDARELLI ANGELO	40.113
2354		HELABA INVEST KAPITALANLAGEGESELLSCHAFT MBH	CARDARELLI ANGELO	45.800
2485		HENDERSON EUROPEAN ENHANCED EQ.	CARDARELLI ANGELO	240.546
2503		HENDERSON GLOBAL INVESTORS	CARDARELLI ANGELO	1.325.095
1103		HENKEL OF AMERICA MASTER RETIREMENT TRUST	CARDARELLI ANGELO	27.644
1861		HF FUND, LP	CARDARELLI ANGELO	26.323
2563		HFZH COFONDS	CARDARELLI ANGELO	30.000
562		HIGHLAND EQUITY COLLECTIVE FUND	CARDARELLI ANGELO	204.568
559		HIGHLAND EQUITY FUND	CARDARELLI ANGELO	331.692
560		HIGHLAND PUBLIC INFLATION HEDGES FUND	CARDARELLI ANGELO	73.758
563		HIGHLAND PUBLIC INFLATION HEDGES FUND	CARDARELLI ANGELO	37.755
869		HIRTLE CALLAGHAN TRUST INTERNATIONAL EQUITY PORTFOLIO	CARDARELLI ANGELO	215.358
3123		HOBART FAMILY INVESTMENTS LLC	CARDARELLI ANGELO	3.141
1948		HONEYWELL INTERNATIONAL INC MASTER RETIREMENT TRUST	CARDARELLI ANGELO	429.300
1812		HONG KONG SAR GOVERNMENT EXCHANGE FUND	CARDARELLI ANGELO	2.025.441
1813		HONG KONG SAR GOVERNMENT EXCHANGE FUND	CARDARELLI ANGELO	385.921
1192		HONG KONG SPECIAL ADMINISTRATIVE REGION GOVERNMENT-EXCHANGE F	CARDARELLI ANGELO	283.469
1211		HONGKONG ELECTRIC DEFINED CONTRIBUTION SCHEME	CARDARELLI ANGELO	4.514
1808		HOSPITAL AUTHORITY PROVIDENT FUND SCHEME	CARDARELLI ANGELO	330.712
1809		HOSPITAL AUTHORITY PROVIDENT FUND SCHEME	CARDARELLI ANGELO	224.743
2632		HOUR GLASS INTERNAT SHARES (UNHEDGED) FU	CARDARELLI ANGELO	79.969
2633		HOUR-GLASS INDEXED INT SHARE(UNHEDGED) F	CARDARELLI ANGELO	30.824

L
3
2

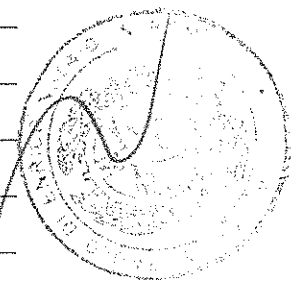

ASSEMBLEA ORDINARIA

81607/1227 12 MAGGIO 2016

Segreteria Societaria - Ufficio Titoli



eni

Unica convocazione

Esito della votazione sul punto 3

Nomina di un Amministratore ai sensi dell'articolo 2386 del Codice Civile

Elenco Favorevoli

SCHEDA	VPC	NOMINATIVO AZIONISTA	DELEGATO	NUMERO DI AZIONI TOTALE
1932		HRW TESTAMENTARY TRUST NO 1	CARDARELLI ANGELO	6.424
1939		HRW TESTAMENTARY TRUST NO 2	CARDARELLI ANGELO	8.635
1931		HRW TESTAMENTARY TRUST NO 3	CARDARELLI ANGELO	15.206
1937		HRW TESTAMENTARY TRUST NO 4	CARDARELLI ANGELO	12.948
1942		HRW TESTAMENTARY TRUST NO 5	CARDARELLI ANGELO	5.162
1936		HRW TESTAMENTARY TRUST NO 6	CARDARELLI ANGELO	7.037
1775		HRW TESTAMENTARY TRUST NO. 10	CARDARELLI ANGELO	15.313
1935		HRW TESTAMENTARY TRUST NO. 11	CARDARELLI ANGELO	16.626
1943		HRW TESTAMENTARY TRUST NO. 12	CARDARELLI ANGELO	22.162
1940		HRW TESTAMENTARY TRUST NO. 7	CARDARELLI ANGELO	3.720
1938		HRW TESTAMENTARY TRUST NO. 8	CARDARELLI ANGELO	11.282
1776		HRW TESTAMENTARY TRUST NO. 9	CARDARELLI ANGELO	15.203
1934		HRW TRUST NO 1 UAD 01/17/03	CARDARELLI ANGELO	9.935
1933		HRW TRUST NO 2 UAD 01/17/03	CARDARELLI ANGELO	11.295
1944		HRW TRUST NO 3 UAD 01/17/03	CARDARELLI ANGELO	11.924
1941		HRW TRUST NO 4 UAD 01/17/03	CARDARELLI ANGELO	11.151
1787		HSBC - NORTH AMERICA (U.S.) PENSION TRUST	CARDARELLI ANGELO	200.450
1683		HSBC AS TRUSTEE FOR SSGA EUROPE EX UK EQUITY TRACKER FUND	CARDARELLI ANGELO	1.592.966
2427		HSBC GROUP HONG KONG LOCAL STAFF RETIREMENT BENEFIT SCHEME	CARDARELLI ANGELO	12.620
1907		HUBBELL INCORPORATED MASTER PENSION TRUST	CARDARELLI ANGELO	4.260
137		HYMNOS L113	CARDARELLI ANGELO	3.187
2443		I CROISSANCE	CARDARELLI ANGELO	31.235
804		I.L.C. ACTIONS	CARDARELLI ANGELO	160.000

ASSEMBLEA ORDINARIA 12 MAGGIO 2016

Segreteria Societaria - Ufficio Titoli



M. Scuderi

Unica convocazione

Esito della votazione sul punto 3

Nomina di un Amministratore ai sensi dell'articolo 2386 del Codice Civile

81607/1998

Elenco Favorevoli

SCHEDA	VPC	NOMINATIVO AZIONISTA	DELEGATO	NUMERO DI AZIONI TOTALE
531		IBERDROLA USA DEFINED BENEFIT MASTER TRUST I	CARDARELLI ANGELO	47.930
532		IBERDROLA USA DEFINED BENEFIT MASTER TRUST I	CARDARELLI ANGELO	23.845
1495		IBM 401K PLUS PLAN	CARDARELLI ANGELO	413.194
1997		IBM DIVERSIFIED GLOBAL EQUITY FUND	CARDARELLI ANGELO	47.059
1998		IBM DIVERSIFIED GLOBAL EQUITY FUND	CARDARELLI ANGELO	108.699
1999		IBM DIVERSIFIED GLOBAL EQUITY FUND	CARDARELLI ANGELO	68.881
204		IBM FRANCE	CARDARELLI ANGELO	56.000
743		IBM H	CARDARELLI ANGELO	6.300
2900		IBM PERSONAL PENSION PLAN TRUST	CARDARELLI ANGELO	82.727
3096		IBM PERSONAL PENSION PLAN TRUST	CARDARELLI ANGELO	112.045
1503		IBM RETIREMENT PLAN	CARDARELLI ANGELO	20.000
805		IDEAM SOLIDARITES	CARDARELLI ANGELO	2.943
2349		IFAG NATURAL RESOURCES FUND	CARDARELLI ANGELO	232.496
569		IG TEMPLETON INTERNATIONAL EQUITY CLASS	CARDARELLI ANGELO	32.762
566		IG TEMPLETON INTERNATIONAL EQUITY FD	CARDARELLI ANGELO	143.042
1966		ILLINOIS MUNICIPAL RETIREMENT FUND	CARDARELLI ANGELO	881.956
1967		ILLINOIS MUNICIPAL RETIREMENT FUND	CARDARELLI ANGELO	749.369
1564		ILLINOIS STATE BOARD OF INVESTMENT	CARDARELLI ANGELO	176.915
1465		IMPACT GLOBAL ALPHA TILTS NON-LENDABLE FUND B	CARDARELLI ANGELO	1.682
686		IMPERIAL INTERNATIONAL EQUITY POOL	CARDARELLI ANGELO	768.825
687		IMPERIAL INTERNATIONAL EQUITY POOL	CARDARELLI ANGELO	76.074
688		IMPERIAL INTERNATIONAL EQUITY POOL	CARDARELLI ANGELO	39.516
689		IMPERIAL OVERSEAS EQUITY POOL	CARDARELLI ANGELO	34.475

M. Scuderi

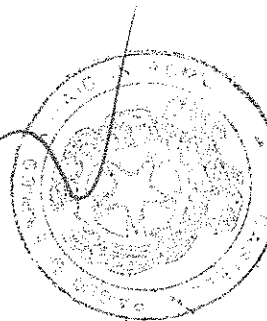

ASSEMBLEA ORDINARIA81607/1229 **12 MAGGIO 2016**

Segreteria Societaria - Ufficio Titoli

**eni**

Unica convocazione

Esito della votazione sul punto 3

Nomina di un Amministratore ai sensi dell'articolo 2386 del Codice Civile**Elenco Favorevoli**

SCHEDA	VPC	NOMINATIVO AZIONISTA	DELEGATO	NUMERO DI AZIONI TOTALE
2733		INDEX MOTHER FUND EURO AREA EQUITY	CARDARELLI ANGELO	670
570		INDIANA UNIVERSITY FOUNDATION	CARDARELLI ANGELO	64.046
747		INDOCAM FLAMME	CARDARELLI ANGELO	57.244
2381		ING DIRECT	CARDARELLI ANGELO	183.006
357		ING DIVIDEND AANDELEN FUND	CARDARELLI ANGELO	92.294
298		ING FUNDS SERVICES, LLC	CARDARELLI ANGELO	150.921
248		ING GLOBAL EQUITY DIVIDEND FUND	CARDARELLI ANGELO	55.486
356		ING INSTITUTIONEEL DIVIDEND AANDELEN FONDS	CARDARELLI ANGELO	125.291
336		ING INVESTMENT MANAGEMENT	CARDARELLI ANGELO	169.503
1908		INOVA HEALTH SYSTEM FOUNDATION	CARDARELLI ANGELO	135.580
1089		INTECH GLOBAL ALL COUNTRY ENHANCED INDEX FUND LLC	CARDARELLI ANGELO	1.776
1769		INTEGRYS ENERGY GROUP RETIREMENT PLAN TRUST	CARDARELLI ANGELO	148.672
1187		INTEL CORPORATION RETIREE MEDICAL PLAN TRUST	CARDARELLI ANGELO	38.854
1834		INTER AMERICAN DEVELOPMENT BANK STAFF RETIREMENT FUND	CARDARELLI ANGELO	29.459
1598		INTERNATIONAL ALPHA SELECT COMMON TRUST FUND	CARDARELLI ANGELO	226.984
1470		INTERNATIONAL ALPHA TILTS FUND B	CARDARELLI ANGELO	92.493
710		INTERNATIONAL BANK FOR RECONSTRUCTION AND DEVELOPMENT	CARDARELLI ANGELO	9.604
711		INTERNATIONAL BANK FOR RECONSTRUCTION AND DEVELOPMENT	CARDARELLI ANGELO	57.212
712		INTERNATIONAL BANK FOR RECONSTRUCTION AND DEVELOPMENT	CARDARELLI ANGELO	17.766
1811		INTERNATIONAL EQUITY FUND	CARDARELLI ANGELO	33.053
1455		INTERNATIONAL EQUITY INDEX PLUS FUNDS B	CARDARELLI ANGELO	16.566
918		INTERNATIONAL EXPATRIATE BENEFIT MASTER TRUST	CARDARELLI ANGELO	13.493
3053		INTERNATIONAL FUND MANAGEMENT S.A. RE IF	CARDARELLI ANGELO	1.115.920

ASSEMBLEA ORDINARIA 12 MAGGIO 2016

Segreteria Societaria - Ufficio Titoli



T
3
C

Unica convocazione

Esito della votazione sul punto 3

Nomina di un Amministratore ai sensi dell'articolo 2386 del Codice Civile

81607/1230

Elenco Favorevoli

SCHEDA	VPC	NOMINATIVO AZIONISTA	DELEGATO	NUMERO DI AZIONI TOTALE
3051		INTERNATIONAL FUND MANGEMENT S.A. RE GLO	CARDARELLI ANGELO	4.300
3052		INTERNATIONAL FUND MANGEMENT S.A. RE IFM	CARDARELLI ANGELO	200.000
924		INTERNATIONAL MONETARY FUND	CARDARELLI ANGELO	33.802
925		INTERNATIONAL MONETARY FUND	CARDARELLI ANGELO	45.552
1836		INTERNATIONAL MONETARY FUND STAFF RETIREMENT PLAN	CARDARELLI ANGELO	4.605
1837		INTERNATIONAL MONETARY FUND STAFF RETIREMENT PLAN	CARDARELLI ANGELO	2.626
915		INTERNATIONAL PAPER CO COMMINGLED INVESTMENT GROUP TRUST	CARDARELLI ANGELO	405.750
1490		INTERNATIONAL PAPER CO COMMINGLED INVESTMENT GROUP TRUST	CARDARELLI ANGELO	121.271
1491		INTERNATIONAL PAPER CO COMMINGLED INVESTMENT GROUP TRUST	CARDARELLI ANGELO	139.859
1454		INTERNATIONAL TILTS MASTER PORTFOLIO OF MASTER INVESTMENT PTF	CARDARELLI ANGELO	60.217
1101		INVESCO MACRO INTERNATIONAL EQUITY FUND	CARDARELLI ANGELO	365
1102		INVESCO MACRO LONG/SHORT FUND	CARDARELLI ANGELO	444
1661		INVESTEC FUNDS SERIES II GLOBAL ENERGY FUND	CARDARELLI ANGELO	175.251
1343		INVESTEC GLOBAL STRATEGY FUND	CARDARELLI ANGELO	1.093.055
290		INVESTERINGSFORENINGEN SPARINVEST CUMULUS VALUE	CARDARELLI ANGELO	31.359
285		INVESTERINGSFORENINGEN SPARINVEST INDEX DOW JONES SUSTAINABILITYWORLD	CARDARELLI ANGELO	24.000
282		INVESTERINGSFORENINGEN SPARINVEST INDEX EUROPA VALUE	CARDARELLI ANGELO	44.011
283		INVESTERINGSFORENINGEN SPARINVEST INDEX GLOBAL AKTIER MIN.RISIKO	CARDARELLI ANGELO	47.100
287		INVESTERINGSFORENINGEN SPARINVEST VALUE AKTIER	CARDARELLI ANGELO	379.131
294		INVESTERINGSFORENINGEN SPARINVEST VALUE EUROPA	CARDARELLI ANGELO	117.820
347		INVESTIN PRO F.M.B.A., GLOBAL EQUITIES I	CARDARELLI ANGELO	108.387
195		INVESTISSEMENT TRESOR VIE	CARDARELLI ANGELO	27.360
568		IOWA PUBLIC EMPLOYEES RETIREMENT SYSTEM	CARDARELLI ANGELO	498.661

L
M
C

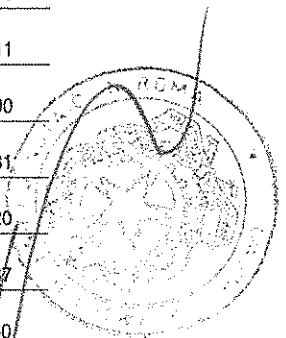

ASSEMBLEA ORDINARIA

81507/1231

12 MAGGIO 2016

Segreteria Societaria - Ufficio Titoli



eni

Unica convocazione

Esito della votazione sul punto 3

Nomina di un Amministratore ai sensi dell'articolo 2386 del Codice Civile

Elenco Favorevoli

SCHEDA	VPC	NOMINATIVO AZIONISTA	DELEGATO	NUMERO DI AZIONI TOTALE
2622		IPAC SPEC INV STR INT SHARE STR no 9	CARDARELLI ANGELO	266.241
2623		IPAC SPEC INV STR INT SHARE STR no 9	CARDARELLI ANGELO	18.163
2099		IPM EQUITY UMBRELLA FUND	CARDARELLI ANGELO	13.715
2100		IPM EQUITY UMBRELLA FUND	CARDARELLI ANGELO	8.351
1076		IPSOL GLOBAL EQUITY FUND	CARDARELLI ANGELO	7.975
390		IQ 50 PERCENT HEDGED FTSE EUROPE ETF	CARDARELLI ANGELO	14.404
403		IQ 50 PERCENT HEDGED FTSE INTERNATIONAL ETF	CARDARELLI ANGELO	15.168
274		IQ ARB GLOBAL RESOURCES ETF	CARDARELLI ANGELO	20.999
2448		IRCOM RETRAITE DIVERSIFIE	CARDARELLI ANGELO	64.760
22		IRISH LIFE ASSURANCE	CARDARELLI ANGELO	1.249.845
3252		IRISH LIFE ASSURANCE PLC	CARDARELLI ANGELO	67.866
3305		IRISH LIFE ASSURANCE PLC	CARDARELLI ANGELO	158.220
3306		IRISH LIFE ASSURANCE PLC	CARDARELLI ANGELO	2.110.756
1424		ISHARES CORE MSCI EAFE ETF	CARDARELLI ANGELO	2.034.012
1427		ISHARES CORE MSCI EAFE IMI INDEX ETF	CARDARELLI ANGELO	77.716
1429		ISHARES CORE MSCI EUROPE ETF	CARDARELLI ANGELO	266.639
1425		ISHARES CORE MSCI TOTAL INTERNATIONAL STOCK ETF	CARDARELLI ANGELO	257.185
1410		ISHARES EUROPE ETF	CARDARELLI ANGELO	963.739
1413		ISHARES GLOBAL ENERGY ETF	CARDARELLI ANGELO	1.356.870
1433		ISHARES GLOBAL MONTHLY DIVIDEND INDEX ETF (CAD-HEDGED)	CARDARELLI ANGELO	48.799
1642		ISHARES I INV MIT TGV F ISHS ST EUROPE600 OIL+GAS UCITS ETF DE	CARDARELLI ANGELO	4.200.501
1607		ISHARES II PUBLIC LIMITED COMPANY	CARDARELLI ANGELO	1.773.998
1609		ISHARES II PUBLIC LIMITED COMPANY	CARDARELLI ANGELO	454.756